

SPALDING®



2020 EQUIPMENT CATALOG

VOLLEYBALL | GYMNASIUM | BASKETBALL

WWW.SPALDINGEQUIPMENT.COM | 800-435-3865



— TABLE OF CONTENTS —

VOLLEYBALL

- 04 | BENEFITS & CUSTOMIZATION
- 06 | FREESTANDING VOLLEYBALL
- 08 | FREESTANDING II VOLLEYBALL
- 10 | LITE STEEL
- 12 | ELITE ALUMINUM
- 14 | ELITE STEEL
- 16 | SLIDE MULTI-SPORT
- 18 | TELESCOPING, TENNIS, & BADMINTON
- 20 | FLOOR PLATES & SLEEVES
- 21 | T-BASES & FLOOR ANCHORS
- 22 | NET PACKAGES
- 24 | NETS & ACCESSORIES
- 25 | VOLLEYBALL PADS
- 26 | REFEREE PLATFORMS
- 27 – 28 | VOLLEYBALL STORAGE





PLAYER ICONS:



OFFICIAL MEMBER OF:



VOLLEYBALL

UPRIGHTS BENEFITS

BASKETBALL

GYMNASIUM

VOLLEYBALL



All Spalding® uprights have a 3" outer diameter of the upright.

OD: Outer Diameter
ID: Inner Diameter

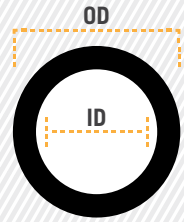

Deflection is the amount an upright bends or bows inward.

All uprights will have deflection, but the amount varies by upright system.



Systems meet FIVB®, NFHS®, and NCAA® specifications.

All Spalding® uprights have infinite height settings due to our telescoping pistons.



Limited Lifetime Warranty:
Competition System Poles
& Pistons



5 Year Warranty:
Multi-Sport Poles
& Pistons



1 Year Warranty:
Parts, Pistons, Nets,
& Accessories

**SPALDING®
SYSTEM
BREAKDOWN:**



SYSTEM NAME:	LITE STEEL	ELITE ALUMINUM	ELITE STEEL	SLIDE MULTI-SPORT
PACKAGE WEIGHT:	99 LBS	82 LBS	162 LBS	85 LBS
UPRIGHT WEIGHT:	49 LBS	35 LBS	70 LBS	41 - 47 LBS
DEFLECTION: <small>Tested at 300lbs of tension at 8</small>	3"	5"	2 - 2½"	3 ¾" - 4"
PAGES OF CATALOG:	10-11	12-13	14-15	16-17

SYSTEM VS. PACKAGE:

ONE-COURT SYSTEM:

- Includes*
- Poles
 - Net
 - Antenna
 - Padding



UPRIGHT PACKAGE:

- Includes*
- Poles
 - Antenna



COLOR OPTIONS

VINYL PADDING COLORS

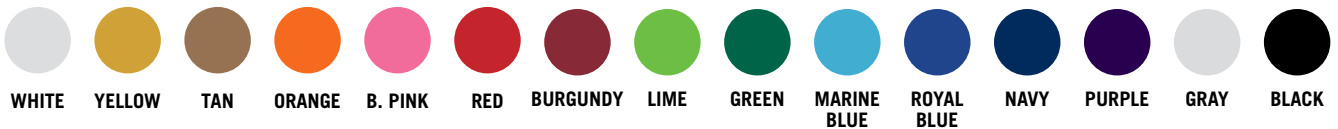

STANDARD POWDER COAT FINISH OPTIONS

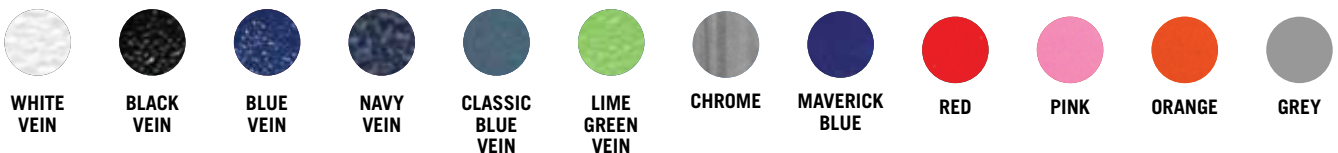

ALL CUSTOM COLOR PRODUCT SALES ARE FINAL | COLORS SHOWN IN CATALOG AND ON WEBSITE MAY NOT BE AN EXACT MATCH.

FREESTANDING VOLLEYBALL

SPALDING® FREESTANDING VOLLEYBALL

Includes the following features:

- Designed to be used where floor plates are not available or in a tournament setting for easy set up and transport
- Each base comes complete with 800 lbs. of steel ballast to ensure they stay in place for play
- Use with specific Spalding® uprights without modification & can adapt to various 3" volleyball upright poles
- Standard 18 oz. navy blue vinyl pads are included. Other colors options are available
- Standard navy blue powder-coated uprights - **custom color available, lead times may vary**
- Custom lettering or logos are available at additional cost. Contact us at 1-800-435-3865 for details
- Warranty: poles and bases, limited-lifetime; pads, net, winch, and antenna, one-year

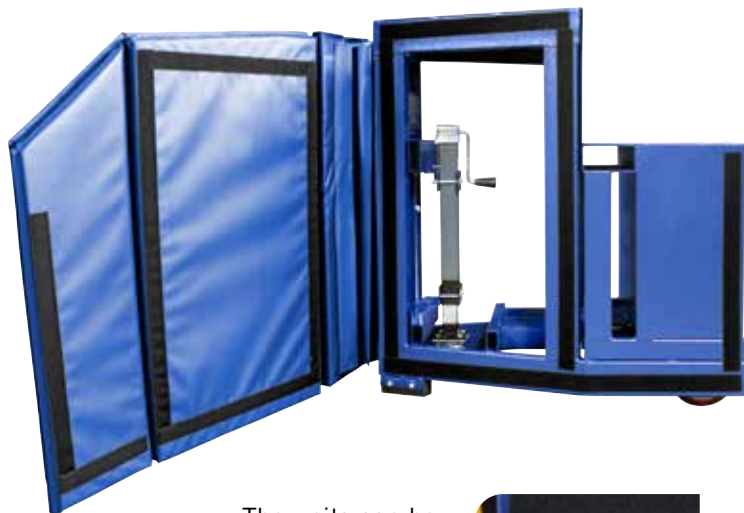

The units can be raised using a 3500 lb. jack in the front for moving into position



RUBBER FOOT



MEN'S



WOMEN'S



JUNIOR'S



VOLUME PRICING



SPALDING
VOLLEYBALL

Whether you need 1 or 40 courts for tournament or normal play, using the Spalding® freestanding volleyball system could not be easier.



Forklifts can be used to move equipment for quick setup or easy storage



FREESTANDING ONE-COURT VOLLEYBALL SYSTEM

System includes:

- 36" Competition Net Package
- Antennae Package
- Winch End Upright for Freestanding VB System
- Non-Winch End Upright for Freestanding VB System

438-165 Freestanding One-Court Volleyball System
 438-150 Base & Pads Only
 438-353 Storage Covers

STANDARD POWDER COAT FINISH OPTIONS - SEE PAGE 5

FREESTANDING II VOLLEYBALL

SPALDING® FREESTANDING II VOLLEYBALL

Includes the following features:

- Designed to be used where floor plates are not available or in a tournament setting.
- Each base comes complete with 1100 lbs of steel ballast to ensure they stay in place for play.
- Use with specific Spalding® uprights without modification & can adapt to various 3" volleyball upright poles.
- Standard 18oz. navy blue vinyl pads are included. Other colors options are available.
- Standard navy blue powder-coated uprights - custom color available, lead times may vary.
- Custom lettering or logos are available at additional cost. Contact us at 1-800-435-3865.
- Warranty: poles and bases, limited-lifetime; pads, net winch, and antenna, one-year.

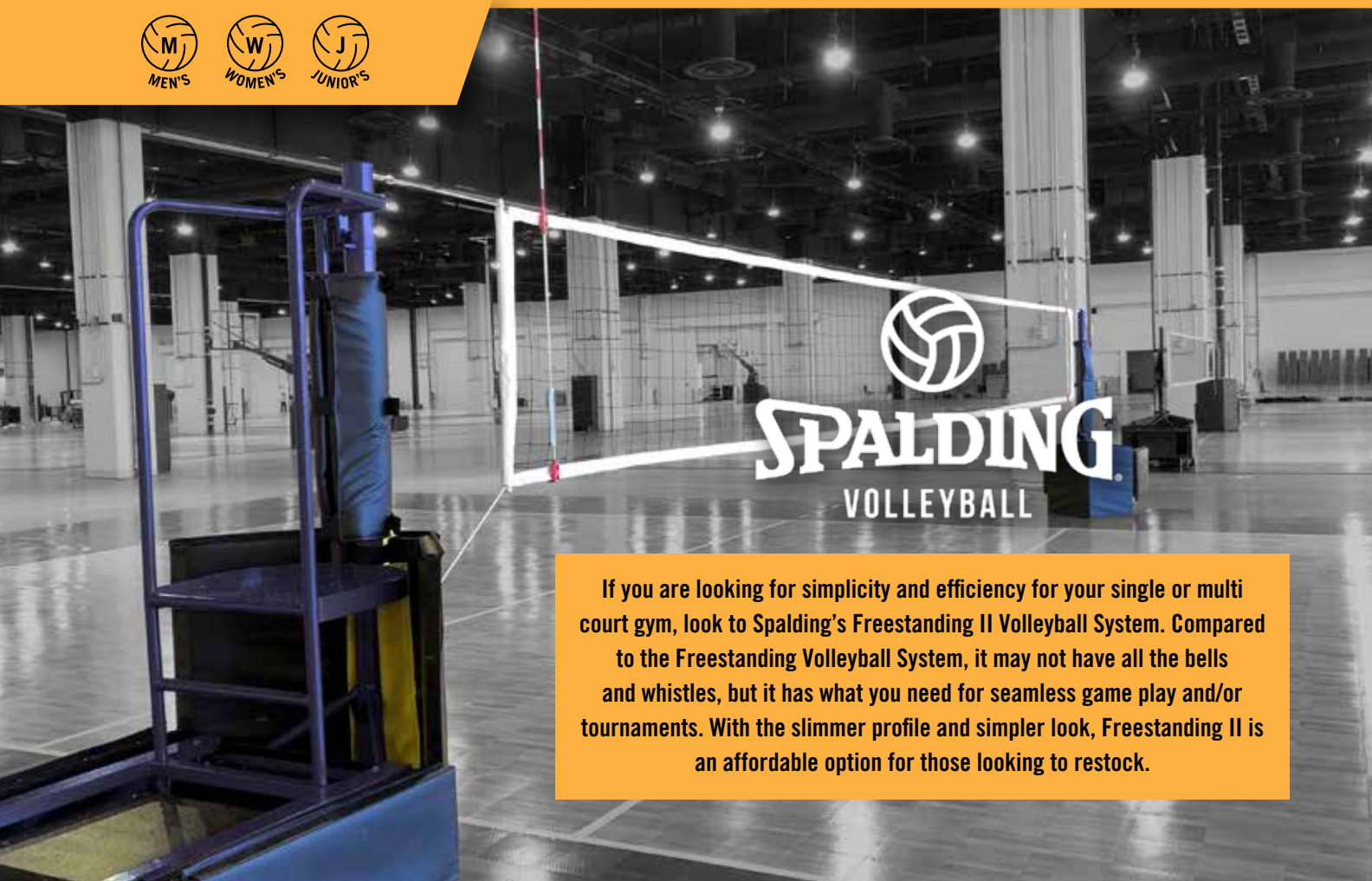

If you are looking for simplicity and efficiency for your single or multi court gym, look to Spalding's Freestanding II Volleyball System. Compared to the Freestanding Volleyball System, it may not have all the bells and whistles, but it has what you need for seamless game play and/or tournaments. With the slimmer profile and simpler look, Freestanding II is an affordable option for those looking to restock.

FREESTANDING II ONE-COURT VOLLEYBALL SYSTEM

System includes:

- 36" Competition Net Package
- Antennae Package
- Winch End Upright for Freestanding II VB System
- Non-Winch End Upright for Freestanding II VB System
- Navy blue vinyl pads package

438-040 Freestanding II One-Court Volleyball System
*Comes fully assembled.



Forklifts can be used to move equipment for quick setup or easy storage

If you have our 8' tournament portable backstop we have a compatible version of the Freestanding II to utilize the carts you have already purchased. Contact Spalding for more information.

TRUCK DIAGRAM

BACK TO BACK CONFIGURATION:

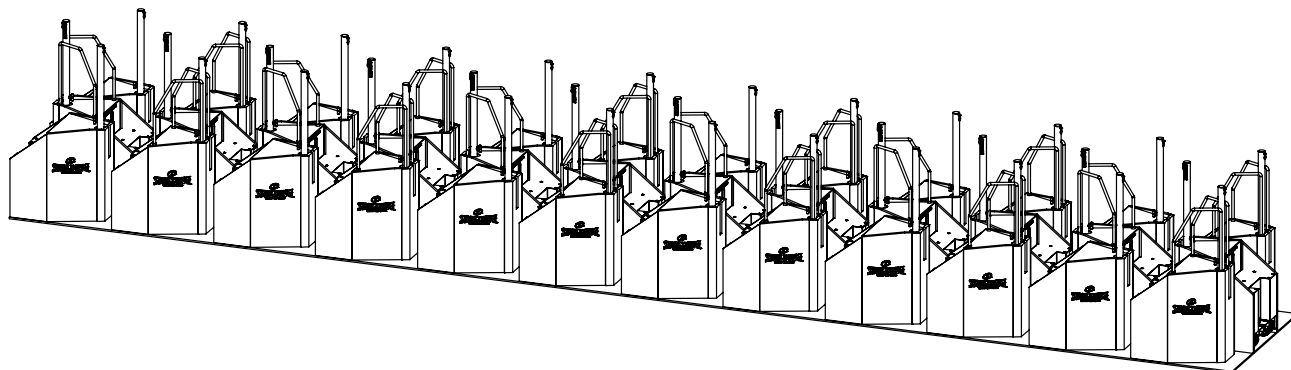

Configuration of units dependent on combination of single and back to back units. Up to 28 units can be shipped on a 53' trailer, subject to backstop configurations and quantity.

LITE STEEL VOLLEYBALL



Lite Steel is a great system offering a variety of play, with similar weight and deflection to an aluminum system.

FEATURES:

- Provides better leverage when changing heights
- Spring-loaded outer telescoping system adds stability while lessening deflection and bowing during play
- Designed to be used with the standard 3" floor sleeves as well as a T-Base
- Not compatible with supported referee platform
- Warranty: poles/piston, limited-lifetime; parts/winch, one-year
- Meets all NCAA®, NFHS®, and FIVB® specifications

LITE STEEL UPRIGHT PACKAGE:

- Includes:
 - 438-275 Spalding® LITE Steel Winch End Upright (includes 408-049 Antenna Package)
 - 438-276 Spalding® LITE Steel Non-Winch End Upright

PACKAGE WEIGHT: 99 LBS	IND. UPRIGHT WEIGHT: 49 LBS	DEFLECTION: 3"
----------------------------------	---------------------------------------	--------------------------

438-274 Spalding® LITE Steel Upright Package

ONE-COURT LITE STEEL SYSTEM:

- Includes:
 - 438-275 Spalding® LITE Steel Winch End Upright (includes 408-049 Antenna Package)
 - 438-276 Spalding® LITE Steel Non-Winch End Upright
 - 434-175 36" Light Weight Net Package
 - SV210-E Upright End Pads - Pair

LWS110 Spalding® One-Court LITE Steel System

LWS210 Spalding® Two-Court LITE Steel System

SYSTEM WEIGHS
34% LESS
THAN TRADITIONAL UPRIGHTS

*Uprights also sold as package or individual pieces. See price list for part #'s and prices.



438-275 Winch End

438-276 Non-winch End

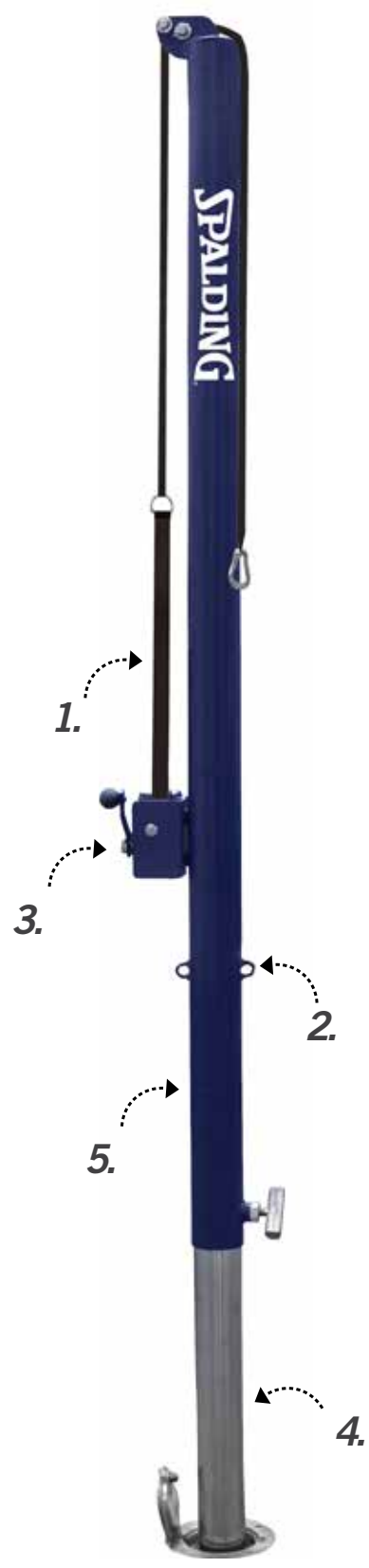

1. NYLON LEADER STRAP: Nylon leader strap for easy net attachment

2. ROPE RATCHET: Locking mechanism permits quick tightening of bottom ropes on net



3. WORM GEAR WINCH: Adjustable height worm gear winch designed to reduce backlash and keep net tight during intense play



4. VISUAL SETTINGS: Men's, Women's, Juniors', and Elementary heights



5. Standard navy blue powder-coated uprights (custom color available, lead times may vary)

6. Requires 3" floor sleeves - sold separately (see page 20 for details)



LITE STEEL SYSTEM WITH SV210 PAD

STANDARD POWDER COAT FINISH OPTIONS - SEE PAGE 5

ELITE ALUMINUM VOLLEYBALL



Its sleek lines and light weight design makes the Elite Aluminum our most popular system for competitive play.

FEATURES:

- Lightweight and easy to set up
- High strength uprights made of 3" (76mm) O.D. extruded aluminum
- Straight piston allowing for clean lines
- Silver vein powder-coat on the piston to help eliminate wear
- Enclosed pulley to help keep the cable from falling
- Center Pole eye bolt for easy net attachment
- Warranty: poles/piston, limited-lifetime; parts/winch, one-year
- Meets NCAA®, NFHS®, and FIVB® specifications

ELITE ALUMINUM UPRIGHT PACKAGE:

- Includes
 - 438-430 Elite Aluminum Winch End Upright (includes 408-049 Antenna Package)
 - 438-431 Elite Aluminum Center Upright

PACKAGE WEIGHT:
82 LBS

IND. UPRIGHT WEIGHT:
35 LBS

DEFLECTION:
5"

438-433 Elite Aluminum Upright Package

ONE-COURT ELITE ALUMINUM SYSTEM

- Includes
 - 438-430 Elite Aluminum Winch End Upright (includes 408-049 Antenna Package)
 - 438-431 Elite Aluminum Center Upright
 - 434-180 1M Competition Net Package
 - SV210-E Upright End Pads - Pair

SEA110 One-Court Elite Aluminum System
SEA210 Two-Court Elite Aluminum System



438-430
Winch End
Upright

438-431
Center
Upright

438-432
Multi-Court

*Uprights also sold as package or individual pieces. See price list for part #'s and prices.



1. PULLEY: Enclosed pulley to help keep the cable from falling

2. PISTON: Spring-loaded, telescoping pistons for easy adjustment regardless of competitive height

3. HEIGHTS: Adjusts to meet (M)en's, (W)omen's and Juniors' height



4. NYLON LEADER STRAP: Nylon leader strap for easy net attachment



5. ROPE RATCHET: Locking mechanism permits quick tightening of bottom ropes on net



6. WORM GEAR WINCH: Adjustable height worm gear winch designed to reduce backlash and keep net tight during intense play



7. Standard navy blue powder-coated uprights (custom color available, lead times may vary)

8. Requires 3" floor sleeves - sold separately (see page 20 for details)

STANDARD POWDER COAT FINISH OPTIONS - SEE PAGE 5

ELITE STEEL VOLLEYBALL



This is the workhorse of all Spalding competition systems. Due to its heavier weight and minimal deflection, its best for use in semi-permanent to permanent settings.

FEATURES:

- High strength uprights made of 3" (76mm) O.D. steel for the highest level of competitive play
- Compatible with T-Base System
- Warranty: poles and piston, limited-lifetime; parts and winch, one-year
- Meets all USAV®, NCAA®, NFHS®, and FIVB® specifications

ELITE STEEL UPRIGHT PACKAGE:

- Includes:
 - 438-291 Elite Steel Winch End Upright (includes 408-049 Antenna Package)
 - 438-292 Elite Steel Center Upright

PACKAGE WEIGHT:	IND. UPRIGHT WEIGHT:	DEFLECTION:
162 LBS	70 LBS	2 - 2 1/2"

438-290 Elite Steel Upright Package

ONE-COURT ELITE STEEL SYSTEM:

- Includes:
 - 438-291 Elite Steel Winch End Upright (includes 408-049 Antenna Package)
 - 438-292 Elite Steel Center Upright
 - 434-180 1M Competition Net Package
 - SV210-E Upright End Pads - Pair

SES110 One-Court Elite Steel System
 SES210 Two-Court Elite Steel System



438-291 Winch End Upright

438-292 Center Upright

438-293 Multi-Court

*Uprights also sold as package or individual pieces. See price list for part #'s and prices.



1. PULLEY: Improved pulley guard is designed to prevent cable misalignment



2. PISTON: Spring-loaded, telescoping pistons for easy adjustment regardless of competitive height

3. HEIGHTS: Adjust to (M)en's, (W)omen's,

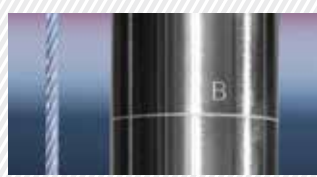

4. NYLON LEADER STRAP: Nylon leader strap for easy net attachment



5. ROPE RATCHET: Locking mechanism permits quick tightening of bottom ropes on net



6. WORM GEAR WINCH: Adjustable height worm gear winch designed to reduce backlash and keep net tight during intense play



7. Standard navy blue powder-coated uprights with chrome plated pistons - custom color available, lead times may vary

8. Requires 3" floor sleeves - sold separately (see page 20 for details)

STANDARD POWDER COAT FINISH OPTIONS - SEE PAGE 5

SLIDE MULTI-SPORT



The most versatile Spalding system to handle most competitive and recreational sports.



FEATURES:



- Lightweight and easy to set up
- High strength uprights made of 3" (76mm) O.D. extruded aluminum
- Easy infinite adjustment regardless of competitive height
- Use at all levels of volleyball, tennis, and badminton
- Warranty: poles and slide, five-year; parts and winch, one-year

ELITE STEEL UPRIGHT PACKAGE:

- Includes:
 - Slide Multi-Sport Winch End Upright
 - Slide Multi-Sport Center Upright
 - 408-049 Antenna Package

PACKAGE WEIGHT:	IND. UPRIGHT WEIGHT:	DEFLECTION:
85 LBS	41-47 LBS	3 3/4 - 4"

438-465 Slide Multi-Sport Upright Package

ONE-COURT SLIDE MULTI-SPORT SYSTEM

- Includes:
 - 438-465 Slide Multi-Sport Upright Package (includes 408-049 Antenna Package)
 - 434-185 36" Competition Net Package
 - SV210-E Upright End Pads - Pair

SS110 One-Court Slide Multi-Sport System
 SS210 Two-Court Slide Multi-Sport System



Winch End

Center

438-466 Multi-Court

*Uprights also sold as package or individual pieces. See price list for part #'s and prices.

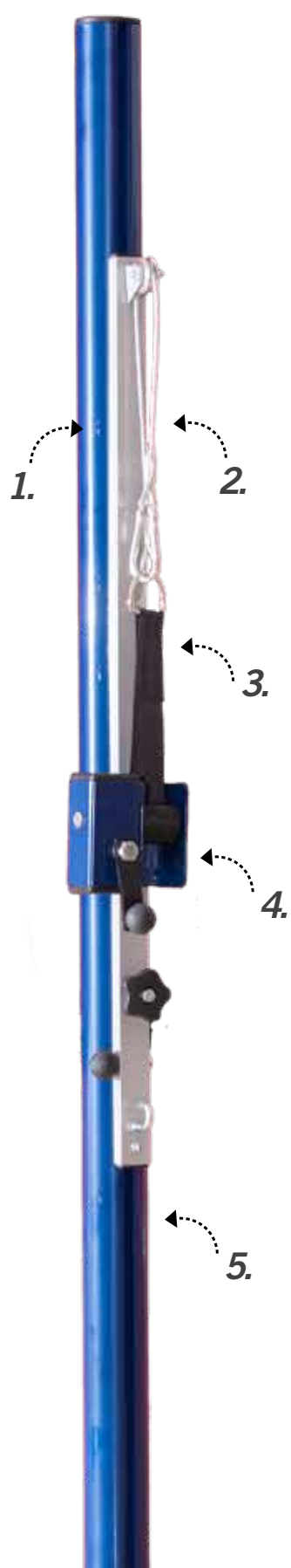

1. MARKINGS: Visual height markings



2. SLIDE MECHANISM: Adjust to (M)en's, (W)omen's, Junior, Elementary, B adminton & Tennis heights



3. NYLON LEADER STRAP: Nylon leader strap for easy net attachment



4. WORM GEAR WINCH: Adjustable height worm gear winch designed to reduce backlash and keep net tight during intense play



5. Navy blue powder-coated uprights with silver powder-coated sliders

6. Requires 3" floor sleeves - sold separately (see page 20 for details)



Slide system at badminton height

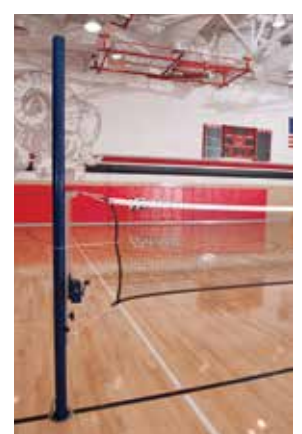

Slide system with SV210 Pads



TENNIS SYSTEM

- System includes two uprights—one with a worm gear winch and one for net tensioning
- Uprights are made of 3" (76mm) O.D. steel with a fixed height of 3' 6" (103cm)
- Floor plate/sleeve not included (see page 20 for floor plate/sleeve options)
- Net not included, sold separately

438-370 Tennis System

438-371 Winch End Upright for two-court play

434-039 Official 42' (12.8m) Tennis Net

434-040 36' (1m) Tennis Net for use on a volleyball court setup



BADMINTON SYSTEM

- System includes two uprights with adjusting height collars and badminton net
- 434-050 Badminton Net - 20' (6.1m) mesh net with 26' (7.9m) long top rope
- Uprights are made of 2" (51mm) O.D. steel tubing
- Floor sleeves sold separately
 - 408-704 Locking Chrome Floor Plate/Sleeve - Pair
 - 408-705 Locking Chrome Floor Plate/Sleeve - Each
 - 408-721 Locking Brass Floor Plate/Sleeve - Pair
 - 408-722 Locking Brass Floor Plate/Sleeve - Each

438-240 Badminton System

MULTI-COURT BADMINTON SYSTEM

- System includes one badminton upright and 434-050 Badminton Net
- Use with a 438-240 to make a two-court continuous set-up

438-241 Multi-Court Badminton System (not shown)



BADMINTON NET PACKAGE

- Telescoping Multi-Sport nets sold separately
- Designed for use with Telescoping Multi-Sport Systems
- 1" square mesh net

434-060 Badminton/Tennis Net

434-120 Quick Set Combo Net - 1 3/4" mesh

FLOOR PLATES & SLEEVES



CHROME FLOOR PLATE/SLEEVE

- Chrome-plated cover plate includes slotted locking mechanism
- Opens with simple turn of a flathead screwdriver or coin
- Cover plate consists of 7" (18cm) O.D. chrome outer ring and hinged chrome cap
- Heavy-duty steel sleeve receives 3" to 3½" (7.6 to 8.9cm) upright and is 8" (23cm) deep
- 1" (2.5cm) clearance required between top of floor and sleeve

-
- 408-785** Chrome Floor Plate/ 3" Sleeve - Pair
 - 408-786** Chrome Floor Plate/ 3" Sleeve - Each
 - 19885** Chrome Cover Plate assembly only
 - 408-700** Locking Chrome Floor Plate/ 3" Sleeve - Pair
 - 408-701** Locking Chrome Floor Plate/ 3" Sleeve - Each
 - 408-702** Locking Chrome Floor Plate/ 3.5" Sleeve - Pair
 - 408-703** Locking Chrome Floor Plate/ 3.5" Sleeve - Each
 - 19875** Chrome Locking Cover Plate assembly only



BRASS FLOOR PLATE/SLEEVE

- Brass-plated cover plate includes slotted locking mechanism
- Opens with simple turn of a flathead screwdriver or coin
- Cover plate consists of 7" (18cm) O.D. brass outer ring and hinged brass cap
- Heavy-duty steel sleeve receives 3" to 3½" (7.6 to 8.9cm) upright and is 8" (23cm) deep
- 1" (2.5cm) clearance required between top of floor and sleeve

-
- 408-725** Locking Brass Floor Plate/ 3" Sleeve - Pair*
 - 408-726** Locking Brass Floor Plate/ 3" Sleeve - Each*
 - 408-727** Locking Brass Floor Plate/ 3.5" Sleeve - Pair*
 - 408-728** Locking Brass Floor Plate/ 3.5" Sleeve - Each*
 - 408-729** Locking Brass Cover Plate assembly only*
- * Prop 65 - contains lead

We can provide adaptors for existing sleeves over 3" diameter to accommodate any Spalding® system. Call customer service at 800.435.3865 for more information.

T-BASES & FLOOR ANCHORS

T-BASE END BASE FEATURES:

- Designed for use in facilities where sleeve installation isn't feasible
- Recommend use with steel uprights only & requires only one floor anchor per end
- Each base has two rubber wheels for easy transporting
- Floor anchors, pads and uprights must be ordered separately



438-318

438-318 T-Base End Bases - Pair
87870 Replacement knob

T-BASE CENTER BASE FEATURES:

- Use only with the following uprights for multiple court setups:
- 438-290 Elite Steel Upright Package
- 438-291 Elite Steel Winch End Upright
- 438-293 Elite Steel Multi-Court Upright
- Requires two floor anchors per unit
- Floor anchors, pads and uprights must be ordered separately



438-319

438-319 T-Base Center Base - Each
87870 Replacement knob

T-BASE PADS FEATURES:

- Easily attached with hook and loop fasteners
- Made with 18 oz. vinyl



438-121

438-123

438-121 T-Base End Base, Navy Pad - Pair
438-123 T-Base Center Base Navy Pad - Each

STYLE B FLOOR ANCHOR

- Installed in securely anchored wood floors
- Replaceable spring-loaded, pop-up cap
- Includes anchoring cement



422-111 Style B Floor Anchor

STYLE BX FLOOR ANCHOR

- Same features as model 422-111, with longer knurled anchor - 3 7/8" (81mm)

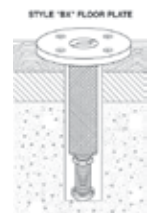

422-211 Style BX Floor Anchor

STYLE C FLOOR ANCHOR

- Installed in concrete and vinyl covered concrete floors
- Replaceable spring-loaded pop-up cap
- Includes anchoring cement

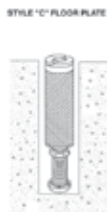

422-112 Style C Floor Anchor

STYLE E FLOOR ANCHOR

- Installed in floating wood floors resting on sleepers or metal clip fasteners
- Features removable cap and anchoring cement
- Measure distance from top of floor to top of concrete to determine model

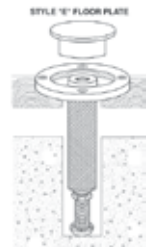

- 422-014** Style E Floor Anchor (less than 2 7/8")
- 422-029** Style E Floor Anchor (2 7/8" to 4")
- 422-030** Style E Floor Anchor (2 7/8" to 5")
- 422-031** Style E Floor Anchor (2 7/8" to 6")
- 422-032** Style E Floor Anchor (2 7/8" to 7")
- 422-034** Style E Floor Anchor (2 7/8" to 9")

NET PACKAGES

NET ORDERING INFORMATION

- Measure the distance between the center of the floor sleeves
- If the measurement is within 35' 5" to 36' 6" a custom net is NOT needed
- If the measurement is above or below 35' 5" to 36' 6", call customer service to order a custom net
- Spalding® nets are only guaranteed to fit Spalding® systems
- 1 year warranty on net packages



CABLE TOP NET STYLE



ARAMID FIBER NET STYLE



SPALDING NETS CAN BE USED
FOR ALL LEVELS OF PLAY

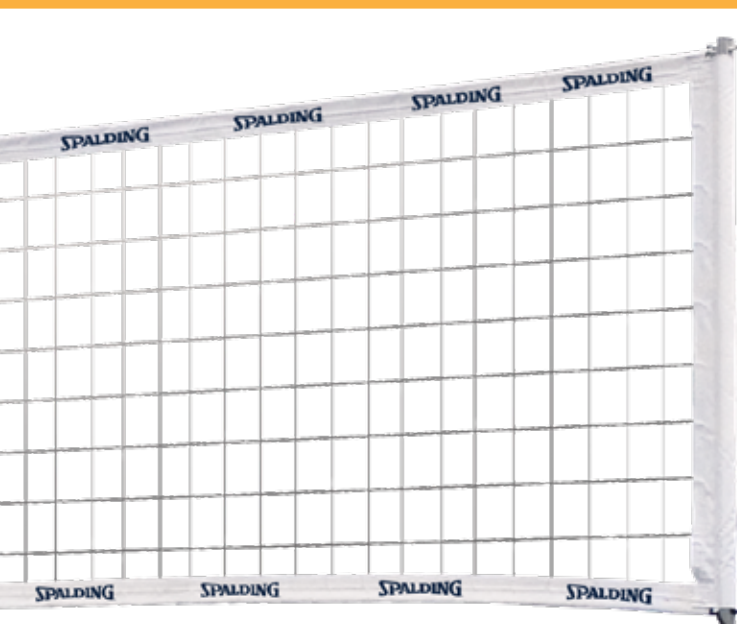

CUSTOM VOLLEYBALL LOGO BANNER PACKAGE

Show your team spirit with graphics which may include school name, insignia, school mascot, and/or advertising which may repeat across banner.

- Meets all volleyball regulations for NFHS®, NCAA®, and USA Volleyball®
- The Custom Volleyball Logo Banner is designed to wrap around the top net tape on standard nets and attach with hook & loop closure

Please contact Spalding at 1-800-435-3865 for ordering information.

NET COMPARISON



**36"
COMPETITION
NET PACKAGE**



**1M
COMPETITION
NET PACKAGE**



**1M
RECREATIONAL
NET PACKAGE**



**36"
LIGHTWEIGHT
NET PACKAGE**

COMPATIBLE SYSTEMS:	Elite Aluminum Elite Steel Slide Systems	Elite Aluminum Elite Steel Slide Systems	Lite Steel Elite Aluminum Elite Steel	Lite Steel Elite Aluminum Slide System
SUGGESTED LEVELS OF PLAY	Pro College High School Junior's	International Pro College High School Junior's	High School Junior's Elementary Recreation	High School Junior's Elementary Recreation
WIDTH:	36" Wide With 4" Square UV Protected Netting	1M Wide With 4" Square UV Protected Netting	1M Wide With 4" Square Mesh	36" Wide With 4" Square Mesh
LENGTH:	32'	32'	32'	32'
TOP CABLE:	33' 9 ³ / ₁₆ " Top Coated Cable	33' 9 ³ / ₁₆ " Top Coated Cable	33' Aramid Fiber Core Rope	33' 9" PVC-Coated Steel Cable
BOTTOM ROPE:	39' Polypropylene Rope	39' Polypropylene Rope	39' Polypropylene Rope	39' Polypropylene Rope
BINDING:	18 oz. Vinyl	18 oz. Vinyl	2" Vinyl Coated Nylon	2" 11oz Vinyl with 18oz Pockets for dowels
NET PACKAGE:	<ul style="list-style-type: none"> • 1¹/₈" Dia. Wooden Dowels (44 ³/₄" long) • Rope Ratchet Pair • Net Tension Straps 	<ul style="list-style-type: none"> • 1¹/₈" Dia. Wooden Dowels (44 ³/₄" long) • Rope Ratchet Pair • Net Tension Straps 	<ul style="list-style-type: none"> • 1" Dia. Steel Dowels (37" Long) • Rope Ratchet Pair • Net Tension Straps 	<ul style="list-style-type: none"> • 1" Wooden Dowels (38 ¹/₂" Long) • Rope Ratchet Pair • Net Tension Straps
ITEM NUMBERS:	434-185 36" Competition Net Package	434-180 1M Competition Net Package	434-214 1M Recreational Net Package	434-175 36" Lightweight Net Package

NET ACCESSORIES

ANTENNA/HOLDER SET

- One pair of regular fiberglass antenna and 2" (51mm) wide white vinyl holders with hook and loop fasteners

408-046 Antenna/Holder Set



NET HEIGHT CHAIN

- Net Height Chain hooks to top of net
- Red indicators on chains show proper net height for men, women, co-ed and various age groups



408-031 Net Height Chain

NET TENSION STRAPS

- Provides proper tension on net dowels, keeping net ends straight
- Set of six 1" (25mm) wide straps with hook and loop fasteners and high impact retainer ring

434-030 Net Tension Straps

ROPE COVERS

- Set of four vinyl volleyball rope covers that attach to the upper and lower ropes or cables of net
- Available in black only



438-072 Rope Covers

ROPE RATCHET

- Locking mechanism permits quick tightening of bottom ropes on net



7147 Rope Ratchet - each

434-020 Rope Ratchet - Pair

SPALDING® ANTENNA PACKAGE

- This package includes two red-and-white-striped antenna assemblies
- Attachment adjustments are made easily and quickly from floor
- Improved clamping mechanism prevents loosening during play
- Adjusts to fit 36" and 1M nets
- Tested to withstand over 60 MPH serves
- Sold as pairs
- One year warranty

ANTENNA PACKAGE



TOP CLAMP

408-049 Antenna Package

IMPROVED

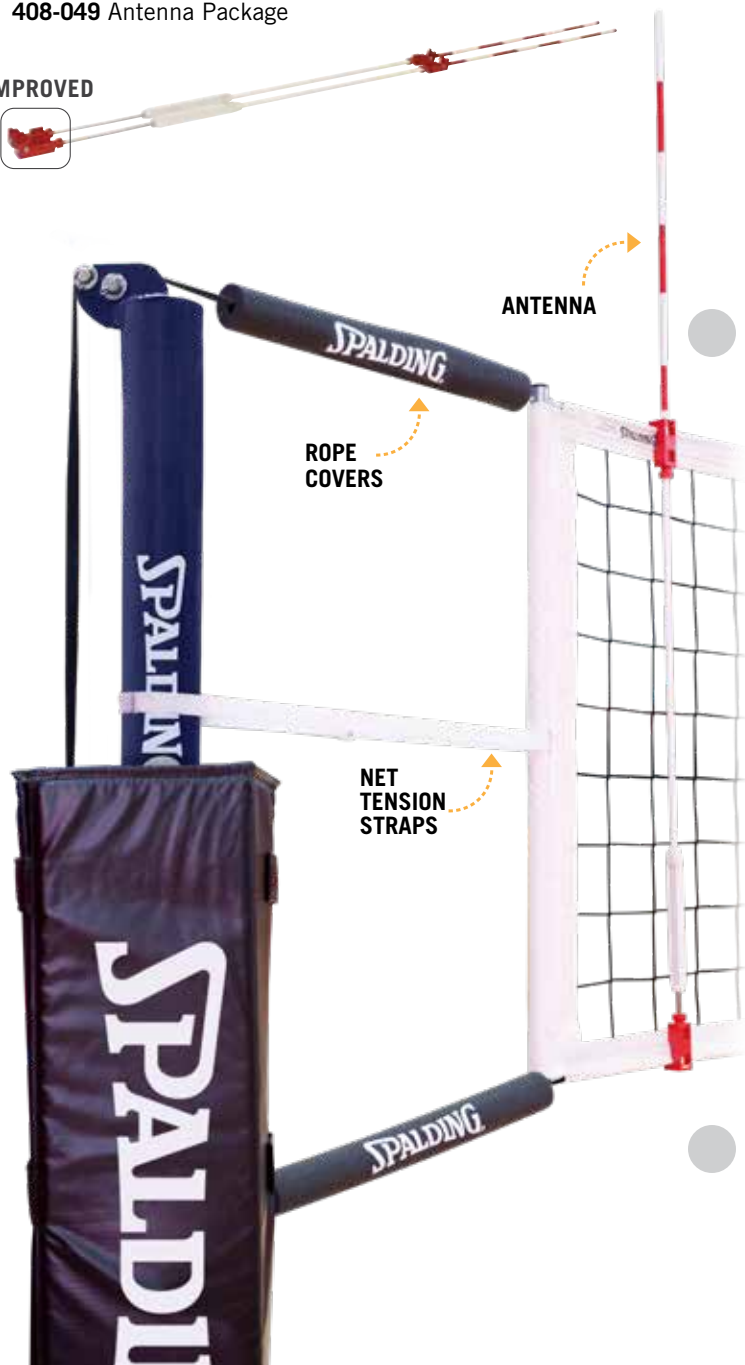

UPRIGHT PADS

BASKETBALL



SV110-E END PAD

SV110-C CENTER PAD

SV110 UPRIGHT END PADS



- Made in one piece for end pads
- Can select a pair of single wrap end pads or a 2-piece center
- Pads are 70" high and 1" thick
- Made of 18 oz. vinyl
- Fifteen colors available

SV110-E End Pads
SV110-C Center Pads

SV110 UPRIGHT PAD SPECIFICATIONS

END UPRIGHTS: 1 PACKAGE - 16 LB. (7 KG), 17" X 18" X 35" (432 MM X 686 MM X 889 MM), 6.19 CF

CENTER UPRIGHT: 1 PACKAGE - 10 LB. (4.5 KG), 17" X 18" X 35" (432 MM X 686 MM X 889 MM), 6.19 CF



SV210 STYLE

SV210 UPRIGHT CENTER & END PADS



- Made in four-sided (two-piece) end pads and center pads
- Can be ordered individually or as a pair
- Pads are 6' high and 1" thick
- Made of 18 oz. vinyl
- Fifteen colors available

SV210-E End Pads
SV210-C Center Pads

SV210 UPRIGHT PAD SPECIFICATIONS

END UPRIGHTS: 1 PACKAGE - 14 LB. (6 KG), 10" X 68" X 10" (254 MM X 1727 MM X 254 MM), 3.9 CF

CENTER UPRIGHT: 1 PACKAGE - 9 LB. (4 KG), 10" X 68" X 10" (254 MM X 1727 MM X 254 MM), 3.9 CF

GYMNASIUM

VOLLEYBALL

AVAILABLE PADDING COLORS - SEE PAGE 5

ACCESSORIES



Folds for
Convenient
Storage

FREESTANDING REFEREE PLATFORM



- Portable unit can be used with any volleyball system
- Base has wheels for easy transporting
- Unit folds for storage
- Platform height is 44" (112cm) high, 29" (74cm) wide
- Unit has protective rubber-tipped legs
- Pads not included
- Standard Navy Blue Powder coat finish – custom color options available see page 5

438-116 Freestanding Referee Platform



FS110



FS210

FREESTANDING REFEREE PLATFORM PADS



- Padding comes in six-piece or one-piece configurations
- Custom colors available - Contact us at 1-800-435-3865 for details

FS110 Freestanding Referee Platform Pads Navy Blue, Six-Piece Set

FS210 Freestanding Referee Platform Pad One-Piece Pad

AVAILABLE PADDING COLORS - SEE PAGE 5

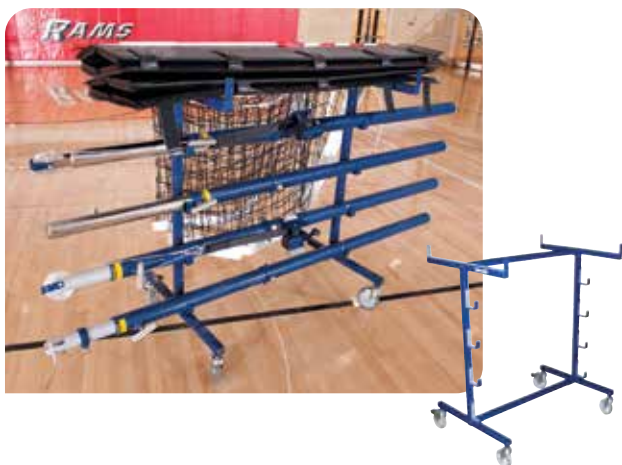

VOLLEYBALL EQUIPMENT CART



- Holds and transports up to four uprights, padding, nets and one referee platform
- Four swivel casters permit travel through a 36" (91cm) doorway

438-127 Volleyball Equipment Cart



VOLLEYBALL EQUIPMENT CARRIER



- Holds and transports up to six uprights, one referee platform, all padding and nets
- Four swivel casters permit travel through a 36" (91cm) doorway

438-057 Volleyball Equipment Carrier



UPRIGHT STORAGE RACK



- Holds all styles of Spalding® uprights
- Attaches to wall to hold uprights in a vertical position
- Lockable for security purposes (padlock not included)
- Removable locking pin allows for easy access to individual uprights

438-413 Upright Storage Rack — Holds 3 Uprights

438-414 Upright Storage Rack — Holds 4 Uprights

NETS & ACCESSORIES

BASKETBALL



Balls, nets & antenna not included



438-132



438-130

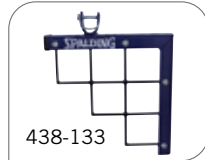

438-133

NET WINDER

The net winder is designed to be used horizontally to wind up a net on the Net Winder Cart or with the Net Winder Wall Mount

- Designed for 36" and one meter nets
- Can be used on most volleyball carts with an outside distance of no more than 49.5"
- Powder-coated for durability and long life
- Includes straps to secure the net to the net winder when winding

438-135 Complete Net Winder Cart (includes cart & 2 winders)

438-132 Net Winder

438-130 Net Winder Cart

438-133 Net Winder Wall Mount

GYMNASIUM



SPALDING® VOLLEYCADDY™

- Innovative cart and carry system
- Kit includes nylon bag with carry strap
- Holds up to 8 volleyballs

438-070 Spalding® VolleyCaddy - Black

438-055 Spalding® VolleyCaddy - Navy*

**Being Discontinued...While Supplied last!*

VOLLEYBALL



WORM
GEAR
WINCH

WORM GEAR WINCH WITH SLIDE COLLAR

- Adjustable height worm gear winch is designed to reduce backlash and keeps net tight during intense play
- Nylon leader strap allows for easy net attachment
- For use on Elite Aluminum & Elite Steel Systems
- Fits on 3" (76mm) O.D. uprights
- One-year warranty

438-383 Worm Gear Winch with Slide Collar

438-380 Worm Gear Winch (not shown)

