



**SPIETH**  
A M E R I C A

Where Innovation Meets Gymnastics



From the data gained from the research, Spieth Anderson pioneered technological advancements in mat and floor production, incorporating superb shock absorption, orthopedic and rebound qualities to respond to the need to minimize injury and absorb impact while responsive to the challenges of creative performance



Spieth Anderson expands sales office in Fort Worth, TX. [1996]

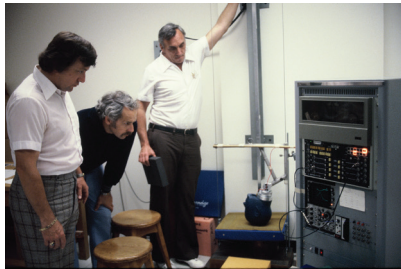

Spieth Anderson began manufacturing the Spieth line in North America [1974]

Murray became focused on elevating equipment performance standards; building equipment that would safely allow gymnasts to push the limits of athletic performance



Starting from gluing carpet to foam, S/A eventually became the first company in North America to use a revolutionary flame lamination process for mat construction in place of glue.



1970

1980

1990



The late Murray & Dolly Anderson partnered with Spieth Gymnastics (Germany) to bring the Original Reuther designed apparatus to the North American market.

Spieth Anderson begins manufacturing in Canada

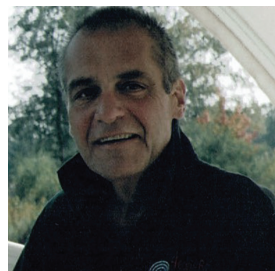

Jeff Anderson, son of Murray and Dolly, joined Spieth Anderson in 1974 and took over as president in the early 1980's. In 1996 Jeff launched Dollamur Sport Surfaces in Fort Worth, Texas, followed by EZ Flex Sport Mats in 2010 to continue focusing on the development of lightweight mats.

[1974-2010]



Throughout the 80's, Spieth Anderson experienced significant growth, prompting additional factory expansion.

The original R&D program expanded with the purchase of a Hybrid 111 biomechanically based car crash dummy for precise, scientific simulation of injury during gymnastics. Used in test situations, it responds much like a human body.\*



[1982 - 1990]

WHERE INNOVATION MEETS GYMNASTICS

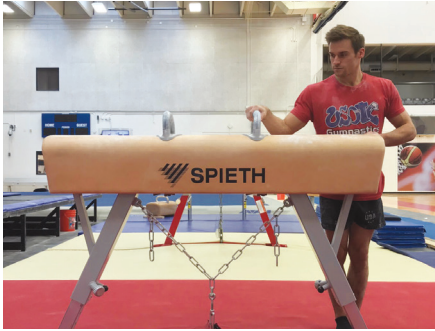

Spieth America announces signing a partnership with 2x Olympian, Samuel Mikulak.



Spieth Canada announces a partnership with Ellie Black to help promote the sport of Gymnastics in Canada and beyond. Ellie is best known for her gymnastics representing Canada on a world class stage with grace and poise.



Spieth America, one of the most trusted names in gymnastics equipment, announces a historic ten year partnership with four-time all-around World Champion gymnast Simone Biles through 2028.



2000

Spieth Anderson ends its partnership with Spieth Holtztechnik in Germany and expands into its updated brand SA Sport.

Murray Anderson retired as president after 29 years dedicated to the development of the sport of gymnastics in North America.

Barb Anderson, daughter of Murray and Dolly, assumes the role of President, and continued her father's vision.



SA Sport refreshes the company logo.

[2007]



SA Sport is acquired by the ABEO Group and Barb Anderson retires.



2010



SA Sport renews their FIG Partner status by obtaining 12 apparatus FIG Approved certificates.

[ 2015]



With the addition of the JF Group to the ABEO Group, SA Sport was able to leverage our past "Spieth" heritage and changes our company name to Spieth America.

[2016]



2020

Bill Wild, former CEO of Spieth America, heads new Abeo North America Organization as CEO with the acquisition of FunSpot Manufacturing.

[2019]



Brent Poulsen the grandson of Spieth Anderson founder, Murray & Dolly Anderson, and son of former CEO Barb Anderson, is named CEO of Spieth America and Spieth Canada.

[2019]



Spieth America becomes the exclusive partner & manufacturer of the Simone Biles Signature line of training products.



[2017]

**NEW!**

**FEATURED NEW PRODUCTS** \_\_\_\_\_ **8-9**

- SA Rec Equipment Line
- All American Uneven Bars
- SA Parkour Equipment Line
- SA Chalk & Grips
- Competition Podium
- Xcel Silver VersaPOD

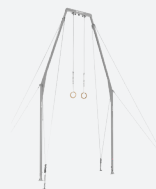

**STILL RINGS** \_\_\_\_\_ **40-41**

- Still Ring Towers
- Training Aids



**PARALLEL BARS** \_\_\_\_\_ **42-43**

- Parallel Bars
- Parallel Bar Training Aids



**VAULT** \_\_\_\_\_ **10-15**

- Vault Tables
- Boards
- Vault Systems
- Vault Accessories



**HIGH BAR** \_\_\_\_\_ **44-45**

- Horizontal Bars
- Horizontal Bar Training Aids



**UNEVEN & TRAINING BARS** \_\_\_\_\_ **16-23**

- Uneven Bars
- Multi & Single Bar Trainers
- Cables & Portable Kits
- Spotting Platforms
- Training Aids



**MENS TRAINING AIDS** \_\_\_\_\_ **46-47**

- Pommel Trainers
- Ring Training Aids
- Parallel & High Bar Trainers



**BALANCE BEAMS** \_\_\_\_\_ **24-29**

- Balance Beams
- Balance Beam Leg & Base Padding
- Low Training Beam
- Training Aids



**MATS** \_\_\_\_\_ **48-53**

- Apparatus Mats & Layouts
- Landing Mats
- Apparatus Mats
- Training Mats
- Panel Mats



**FLOOR EXERCISE** \_\_\_\_\_ **30-35**

- Spring Floors
- FIG Approved
- Floor Rolls
- Carpet, Foam, Hook and Loop Only
- Accessories



**INFLATABLES** \_\_\_\_\_ **54-55**

- Tracks
- Beams
- Inflatable Shapes & Training Aids



**POMMEL HORSE** \_\_\_\_\_ **36-39**

- Pommel Horse
- Pommel Horse Training Aids

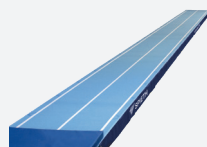

**TUMBLING & TRAMPOLINE** \_\_\_\_\_ **56-61**

- Trampolines
- Tumbl Trak & Rod Floors
- Double & Mini Tramps
- In-Ground Pits & Trampolines
- Pit Modules



**SIMONE BILES SIGNATURE PRODUCTS \_\_\_\_\_ 62-65**

Simone for Home Packages  
 Simone Training Aids  
 Balance Beams  
 Landing & Panel Mats



**SHINOBI TRAINING 74-81**

Climbing Island  
 Equipment Packages  
 Mats & Shapes  
 Ninja Training Aids



**JUST FOR KIDS \_\_\_\_\_ 66-69**

Circuits  
 Mats  
 Cantilever Bars  
 Equipment  
 Accessories & Padding



**PARKOUR \_\_\_\_\_ 82 - 85**

Equipment Packages  
 Parkour Training



**MEET RENTALS \_\_\_\_\_ 86 - 91**

World Class Meet Production  
 3D Gym Design



**SHAPES & TRAINING AIDS \_\_\_\_\_ 70-73**

Complete Circuits  
 Individual Recreational Products



**SA CHALK & GRIPS \_ 92 -93**

Spieth America Chalk  
 Spieth America Grips



**COMMON PARTS \_ 94 -95**

SA Chalk  
 Grips  
 Parts



WHERE INNOVATION MEETS GYMNASTICS



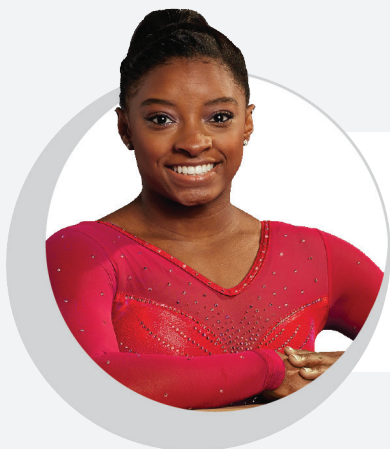

**SIMONE BILES** | 4 x Gold Medalist

"Spieth America's gymnastics equipment is the most innovative equipment in the world allowing me to train harder and recover faster! My favorite Spieth America product is the Moscow Floor which I train on regularly at The World Champions Centre."

**ELLIE BLACK** | 2 x Olympian

"Spieth America has been my favorite brand of equipment to use during training and I have been using it for most of my gymnastics career. I'm looking forward to working with a company that has been part of my development and journey as a gymnast and that really understands the sport and its athletes."



**SAM MIKULAK** | 2 x Olympian

"Spieth America is the future of gymnastics. As I get older, my body needs the extra attention with safety and reliability in which Spieth America provides. Not to mention, they are the leading brand internationally, and training on their equipment will help prepare me for some of the biggest future competitions."



**KIM ZMESKAL** | 2016 USOC Coach of the Year

"As an Olympic gymnast, and now a coach, gymnastics has seemingly always been my playground filled with the likes of bars, beams, and mats galore! Spieth America and I share the same high quality, top notch expectation from the equipment upon which gymnastics magic is created."



**GUSTAVO MOURE** | Olympic Coach

"Everyone here at Excalibur loves Spieth Equipment; the athletes rave about the rebound of the floor they get when tumbling, yet they're able to control their landings with the softness of the shock absorbing floor."

**LIANG CHOW** | 2008 & 2012 Olympic Coach

"I am thrilled to use Spieth equipment at my world class gymnastics events. Currently, the Performance Series Crank Beam and All American Uneven Bars have greatly improved the training in my gym. Spieth America is constantly inventing and improving the safety of athletes through their product development. I am very excited to see what other advances Spieth America brings to the gymnastics world!"

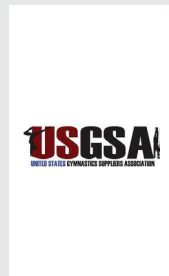
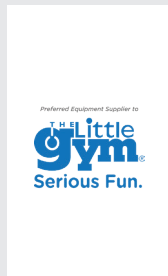
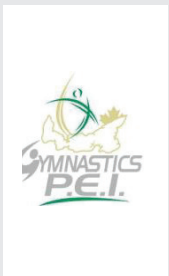

NEW!



[PAGE 13]



[PAGE 27]



[PAGE 17]

### ALL AMERICAN UNEVEN BARS

Built-in levers on uprights allow easy height adjustment.

### TENSIONING MEASURING DEVICE

Provides additional safety and a prevention of too high or too low cable tensioning



[PAGE 16]



[PAGE 82]

### SA PARKOUR

The Parkour System is a modular series of plyometric boxes, rails and accessories adaptable to any space. It can be used on any side and in an endless array of configurations.



[PAGE 92]



[PAGE 93]

### CHALK UP WITH SPIETH AMERICA

All NEW Speith America Chalk and complete line of Grips! Proudly offering a wide selection of grips to all levels of gymnasts. From entry level gymnasts just learning the sport, to Olympic level gymnasts competing on the world's stage.





[PAGE 38]

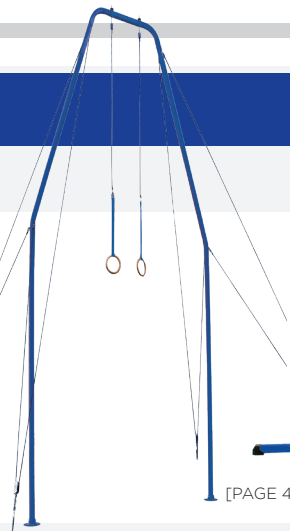

[PAGE 41]



[PAGE 43]



[PAGE 45]

## MIX 'N MATCH ACCESSORIES



Climbing Island, Just for Kids & Shinobi Training customized unlimited possibilities of fun!

Climbing Island products on pages 72-73  
Just for Kids products on pages 74-79  
Shinobi Training products on pages 76-81



## XCEL SILVER VERSAPOD

Vault mat systems meet all USAG Xcel specifications. System can be reconfigured to provide any combination as shown (optional curved top available).

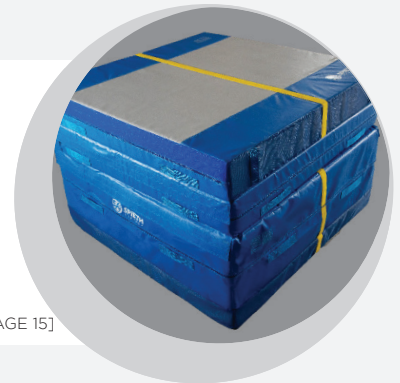

[PAGE 15]

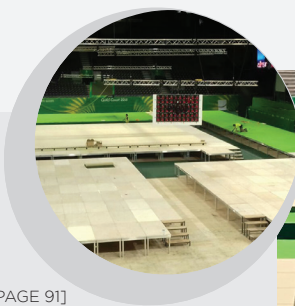

[PAGE 91]

## COMPETITION PODIUM

Bringing world class meet presentation to North America. This competition podium has been featured at numerous international championships.

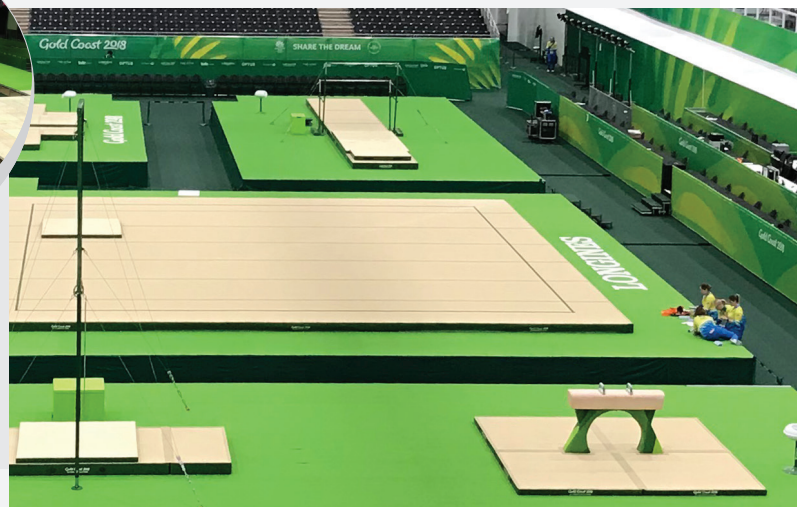

## SIMONE BILES

2019 Stuttgart World Cup

Product:  
Ergojet Vaulting Table [1407210]



"My favorite vault table to train and compete on is the SPIETH America Ergojet. I think the Ergojet is the most stable and explosive vault table on the market and it has a special high absorption top which really reduces the impact on my joints. The vault also has gas shocks for easy height adjustment and comes with a built-in transport system so even I can move the vault table around the gym if needed. I'm really excited to earn the opportunity to compete on the Ergojet in both Stuttgart and Tokyo."

**SIMONE BILES** | 4 x Gold Medalist

## INTERNATIONAL ERGOJET VAULTING TABLE

[1407210]



## Equipment Features

- Built-in transportation system and column padding included
- Simple gas spring height adjustment from 100 to 140 cm in 5 cm increments
- Improved resilience and stability
- For training and competition use
- Used at 2016 Rio Olympics



Height Adjustment System



Transportation System

## Optional base padding available

**5005-006-4** Optional Base Padding 4' x 4' x 20 cm (shown)

**5005-006-8** Optional Base Padding 8' x 4' x 20 cm

**5005-007-4** Optional Base Padding 4' x 4' x 12 cm

**5005-007-8** Optional Base Padding 8' x 4' x 12 cm



## COMPETITION PERFORMANCE SERIES VAULT TABLE II [5002]



### Equipment Features

- New gas spring and handle for smooth and easy height adjustments
- High absorption top drastically reduces the impact on joints
- Column padding included
- Simple height adjustment from 100 to 140 cm in 5 cm increments
- Table top covered with a tough, non-slip material
- Wide base and easy leveling footpads provide improved stability
- For training and competition use



Height Adjustment System



### VAULT BLOCK TRAINER [5005-400]

- Helps gymnasts learn proper pre and post-flight technique
- Quickly fastens to any vaulting table
- Ribbon height can be adjusted



### Optional base padding available

- 5005-003-4** Optional Base Padding 4' x 4' x 20 cm (shown)
- 5005-003-8** Optional Base Padding 8' x 4' x 20 cm
- 5005-004-4** Optional Base Padding 4' x 4' x 12 cm
- 5005-004-8** Optional Base Padding 8' x 4' x 12 cm

NEW!

## RECREATIONAL SA REC VAULT TABLE [REC-5001]

### Equipment Features

- High absorption top drastically reduces the impact on joints
- Column padding included
- Simple height adjustment from 110 to 140 cm in 5 cm increments
- Table top covered with a tough, non-slip material
- Wide base and easy leveling footpads provide improved stability
- For training and competition use
- Gas spring and handle for smooth and easy height adjustments

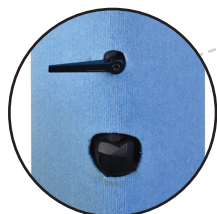

Height Adjustment  
System

### PERFORMANCE SERIES ROUND-OFF ENTRY PAD [622]

- Provides a fast and non-slip response
- Includes hook fasteners to secure to vault runway
- 47 1/4" L x 39 3/8" W x 1" H





## INTERNATIONAL SOFT COMPETITION



[1411704]

- FIG certified ("Soft"), 5 alloy steel springs
- Carbon fiber reinforced top board
- Removable transport castors included
- For experienced vaulters, women's vaulting and men's backwards vaulting
- For 40-75 kg / 88-165 lbs



## HARD COMPETITION



[1411714]

- FIG certified ("Hard"), 8 alloy steel springs
- Carbon fiber reinforced top board
- Removable transport castors included
- For top gymnasts, forward vaults for fast and powerful gymnasts
- For 50-100 kg / 110-220 lbs



## COMPETITION

### PERFORMANCE SERIES ACCELERATOR

[5002-334]

- Four blue ("Hard") and three red ("Soft") interchangeable coil springs
- For Ages 10-15 years and experienced vaulters
- Up to 80 kg / 176 lbs



## RECREATIONAL

### JUNIOR ACCELERATOR

[334J]

- Extremely light-weight with great stability
- Six red ("Soft") easy to remove coil springs
- For Ages 6-12, basic vaulting experience
- Up to 40 kg / 88 lbs



## TRAMP BOARD "XCEL"

[5006-100]

- Halfway between a springboard and a mini trampoline
- Has been developed specifically for all learning and working skills of vaulting exercises
- Increases the power of a gymnast
- Same length as a standard springboard
- Easily transportable with built-in wheels
- Up to 60 kg / 132 lbs

## VAULT RUNWAYS

- Made with high-performance polyethylene sports foam and flame laminated high quality carpet
- 36" W x 82' L
- Meets USAG and NCAA specifications
- See page 41 for other available color options

- 177-125** 1 3/8" Vault Runway
- 177E** 1" Runway with EVA foam



## VAULT SAFETY ZONES

Surrounds the vaulting board to keep gymnasts safe during round-off entry vaults.

- 5005-300** Non-Folding
- 5005-200** Folding



## FOAM TABLE TRAINER [CFT-135]

- Consists of four sections as shown, total 125 cm high
- Includes hook fasteners to secure sections together and attach to a carpet surface
- CFT-135-10 sold separately to reach 135 cm

Trainer consists of four sections:

- 40 cm (15 3/4")
- 60 cm (23 3/16")
- 10 cm (3 15/16")
- 15 cm (5 27/32")

Total height is 125 cm (49 3/16").



## SIMPLE TABLE TRAINER [CFT-115]

- Consists of one 115 cm high top section only
- Includes hook fasteners to secure trainer to a carpet surface

NEW!

## XCEL SILVER VERSAPOD [456-xcel]

- Vault mat systems meet all USAG Xcel specifications
- System can be reconfigured to provide any combination as shown (*optional curved top available*)
- All mats include fasteners to secure together, and hand placement mark at 32" from the front edge

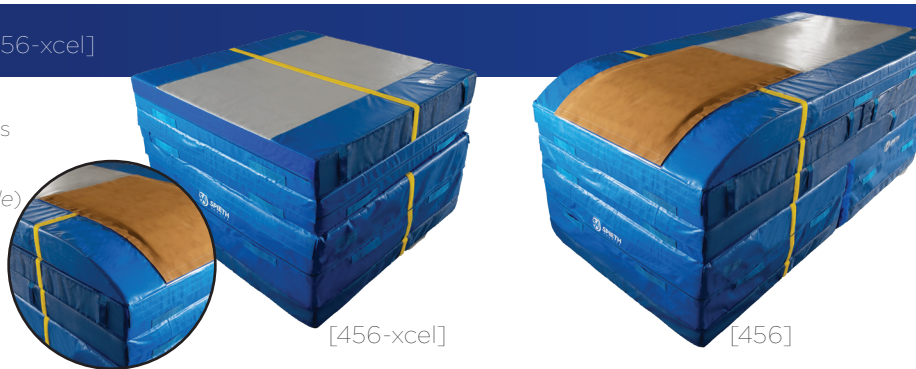

## VERSAPOD [456]

- Multi-functional versaPOD:
  1. Level 4 Vaulting
  2. Xcel Vaulting
  3. Functional Training system in training centers
- Bottom Layer: 5'x5'x24" x 2, Middle Layer: 5'x5'x8" x 4, Top Layer: 5'x10'x8" x 1 with Anti-Skid Material on bottom
- Rounded front to develop vault progressions as gymnasts transition to the vault table
- 60" width vaulting zone stripe on each layer of system
- Meets specifications for all USAG Vaulting requirements for J.O. and Xcel programs

- 456-5108** Middle Layer with Yellow Boundary Line: 5' X 10' X 8"
- 456-5524-1** Bottom Layer Mat with Yellow Boundary Line: 5' x 5' x 24"
- 456-5524-2** Bottom Layer Mat Two: 5' x 5' x 24"
- 456-558-1** Middle Layer Mat with Yellow Boundary Line: 5' x 5' x 8"
- 456-558-2** Middle Mat Layer Two: 5' x 5' x 8"
- 456-55TOP** Curved Top with Vault Cover: 5' X 5' X 8"
- 456-TOP** Curved Top with Vault Cover: 5' X 10' X 8"

**INTERNATIONAL "BERN" UNEVEN BARS**  
[1383200]



**Equipment Features**

- FIG certified
- Carboflex veneered fiberglass rails
- Patented double tensioning system with sliders
- High Bar adjusts from 230 to 280 cm in 5 cm increments
- Low Bar adjusts from 150 to 200 cm in 5 cm increments
- Width diagonal adjusts from 110 to 185 cm
- Width adjuster includes competition markings
- Includes transport system
- Replacement Rail Recommended: 2204130

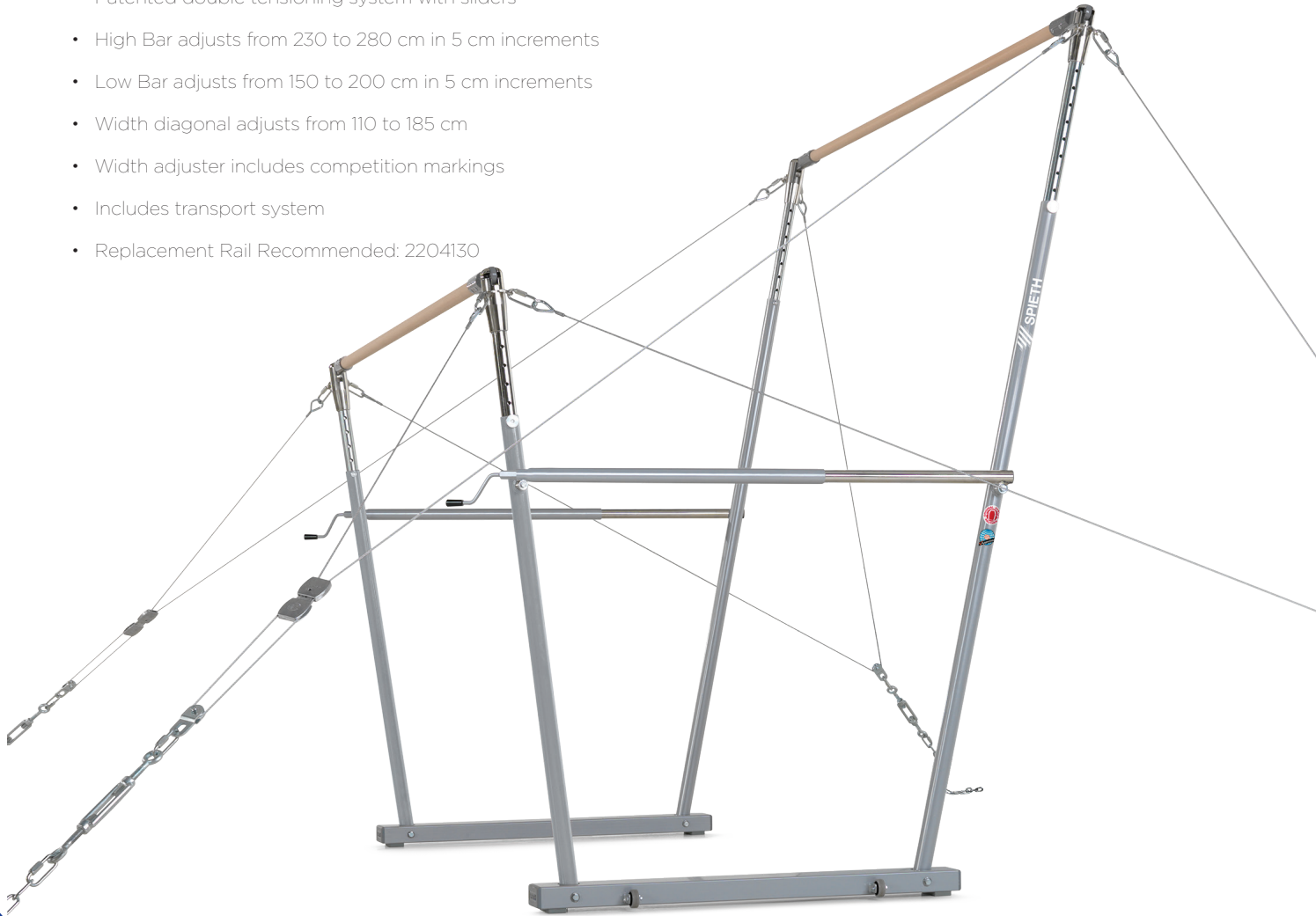

**NEW!**

**TD-TENSIONING MEASURING DEVICE**  
[1760950]

**Equipment Features**

- Provides additional safety and a prevention of too high or too low cable tensioning
- When tensioning becomes too low or too high it is shown by means of a flashing light signal





IMPROVED!

COMPETITION PERFORMANCE SERIES ALL-AMERICAN UNEVEN BARS -  
6-ACSYS CABLES  
[5101-130]

**Equipment Features**

- Carboflex veneered fiberglass rails
- Gas spring assisted height adjustment
- Built-in levers on high bar uprights allow easy height adjustment without using a block
- Includes both American and FIG markings
- High Bar adjusts from 155 to 185 cm in 5 cm increments
- Cable attachment points efficiently allow bar adjustments without altering cable length
- Built to FIG, USAG and NCAA specifications
- Replacement Rail Recommended: P121-100A & 2204130

**5101-120** All-American Uneven Bars with Standard Cables & Carboflex Rail

**5101-130** All-American Uneven Bars with 6 Acsys Cables & Carboflex Rail

**5101-140** All-America Uneven Bars with Standard Cables & New Fiber Rail

**5101-145** All-American Uneven Bars with 6 Acsys Cables & New Fiber Rail

- See all rail options on page 22

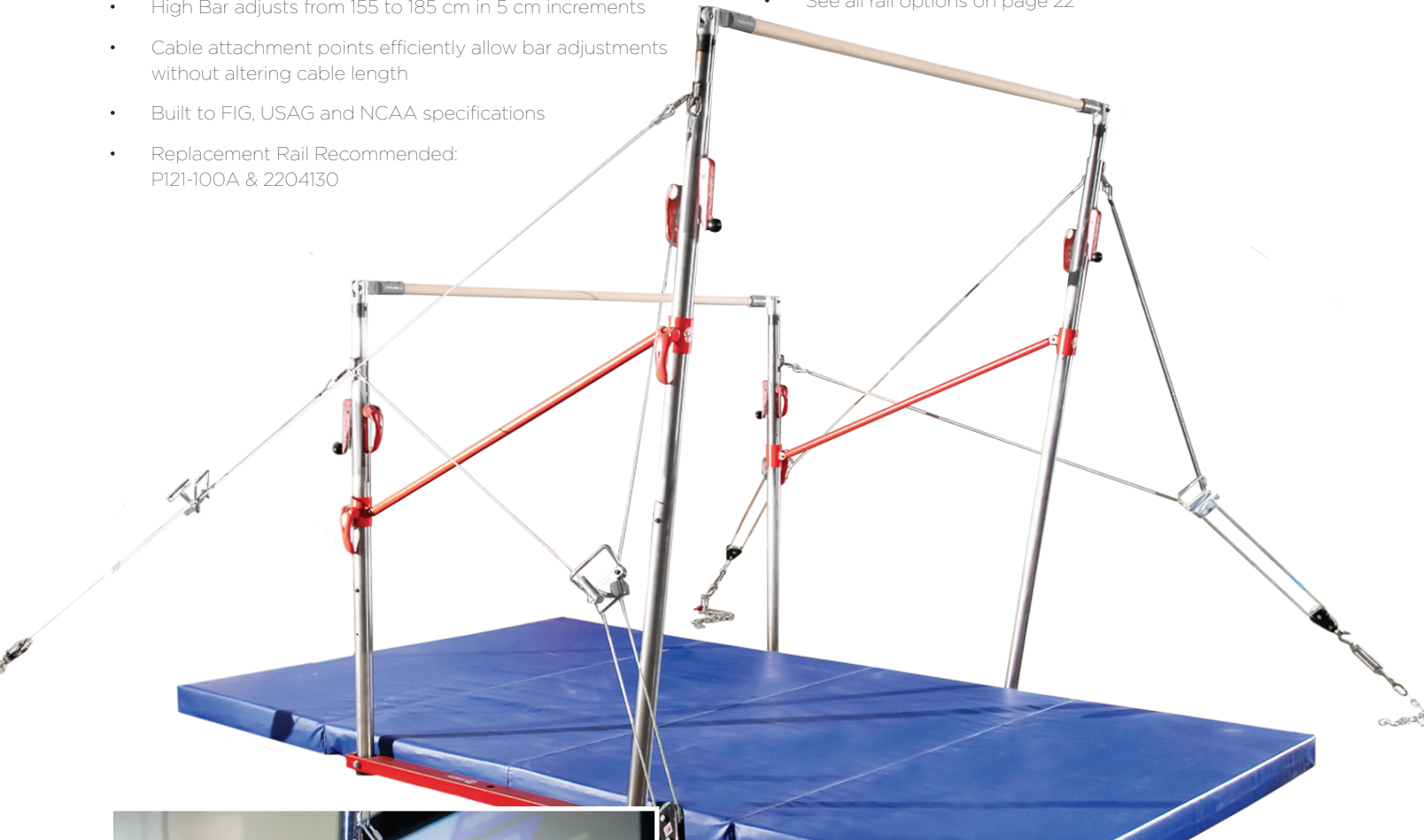

"There's no secret at my lack of height, but with these All American Uneven Bars by SPIETH America, even I don't have to jump or use a block to set the high bar. There is an innovative gas spring system that makes it easy for the high bar to go up, and for the high bar to come back down. Not to mention that the gymnasts and coaches love them because the markings on the side are just like those in the American market."

**KIM ZMESKAL** | 2016 USOC Coach of the Year

## RECREATIONAL UNEVEN PRO BARS II

[122PB-120]

### Equipment Features

- Carboflex veneered fiberglass rails
- Widest bars on the market
- Cables attach to uprights allow bar adjustments without altering cable length
- High bar adjusts from 225 cm to 275 cm in 5 cm increments
- Low bar adjusts from 140 cm to 180 cm in 5 cm increments
- Width Adjustment from 107 cm to 216 cm in 4 cm increments
- Built to FIG, USAG and NCAA specifications
- *Cable covers are sold separately*



**122PB-130**

Uneven Bars II with 6-Acsys Cables

See rail options on page 15



### Optional Landing Mats

|             |  |
|-------------|--|
| <b>427</b>  | 7.5' x 12' x 20 cm (Folding)             |
| <b>435</b>  | 7.5' x 12' x 12 cm (Folding)             |
| <b>444</b>  | 3.25' x 6.5' x 2" (Sting Mat)            |
| <b>417T</b> | 5' x 10' x 8" (Tapered End Training Mat) |

## FREESTANDING UNEVEN BARS

[1383124]

### Equipment Features

- Freestanding without tensioning for training
- Includes built-in transport system
- Quick adjustments
- Optimal tensioning cables
- Smoothly adjustable width from 130 cm to 205 cm in 5 cm increments



**5200-100**

Landing Mat set for Freestanding Uneven Bars

**4140705**

Men's Rails for Freestanding Uneven Bars (Optional)



## MAXIMIZERS

[124]

### Equipment Features

- Reduces required floor space by 40% over conventional layout
- Bases are mounted on the floor for extra stability
- Can be used with all uneven bars on the market that meet FIG specifications





## ADJUSTABLE SINGLE BAR TRAINER [5176-010]

- Easy assembly, dismantling and tension adjustment via load binders
- Rail height adjusts from the ground
- Rail adjusts from 95 to 275 cm in 20 cm, then 10 cm increments
- Ideal for training and learning
- Pair with spotting platform for ultimate training/coaching system (sold separately)

**5176-010-M** Includes Men's Rail [GN3110]

**5176-010-WSOFT** Includes Women's Soft Rail [GN3260]

**5176-010-WHARD** Includes Women's Hard Rail [GN3262]

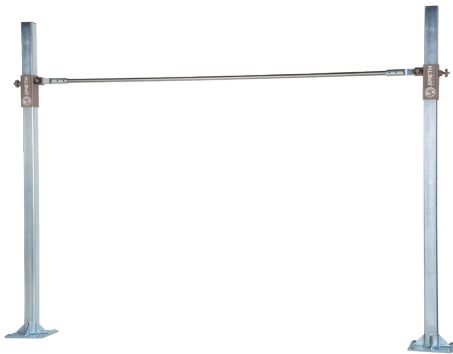

## METHODICAL TRAINING BAR [5177]

- Minimal floor space required
- Ideal for tight areas - no cables required
- Quick and easy height adjustment
- Rail adjusts from 14" to 6'5" in 3" increments

**5177-M** Training bar with Men's Steel Rail [4140705]

**5177-W** Training bar with Women's Fiberglass Rail [2202205]



## POLARIS QUAD BAR SYSTEM [4000]

- Ideal for training and learning
- Bases are anchored to the floor - no cables are required
- Rails adjust from 8" to 5'6" in 1" increments
- Available with 6' or 8' rails
- Mat systems are available for both lengths (6' & 8')

**4006** Polaris Quad Bar with 6' Rails [CLEVIS 6]

**4008** Polaris Quad Bar with 8' Rails [CLEVIS 8]

**4006M** Polaris Quad Bar with 6' Rails (Includes Mats)

**4008M** Polaris Quad Bar with 8' Rails (Includes Mats)



## MULTI-PURPOSE MAT [5186-001]

- Comprised of supple and shock absorbing foam
- Covered with soft elastic jersey
- Ideal for beam and bars training
- 38" W x 55" L x 3/4" H

## NEW AND IMPROVED ALL-AMERICAN SPOTTING PLATFORM [5175]

- Platform can tilt to accommodate upright angle
- Automatically retracts to upright position with gas springs
- Fits most round upright tubes on the market with correct adapter
- Each platform 27" X 27" holds up to 200 lbs



## SPIETH TRAINER PLATFORM [1490373]

- For uneven bars, high bars and over landing pits
- Anchored to floor and not attached to equipment
- Stairs can be positioned on any of the 3 sides
- Height adjusts from 57 1/2" to 75" in 4" increments
- Non-Slip platform is 47" x 20" and retracts automatically to upright position with gas springs



## SPOTTING BLOCKS

- Extremely firm and stable surface for spotter movement
- Includes handles to facilitate transportation around the gym

**CSB-1** 24" W x 60" L x 20" H

**CSB-4** 24" W x 30" L x 20" H



## ANTI-SKID MOUNTING BLOCKS

- Light weight and excellent tool for teaching approach technique
- Firm and ideal for mounts on beam and uneven bars
- New anti-skid material

**5006-010** Half Size - 24" W x 36" L x 9" H

**5007-010** Full Size - 24" W x 48" L x 9" H





**SIMONE BILES**

2019 Stuttgart World Cup

Products:

"Bern" Uneven Bars [I383200] | page 14

Natural Fiber Competition Rail [P121-100A] | shown below

Natural Fiber Competition Rail [P121-100A]  
(Patent Pending)



Natural Fiber Training Rail [P121-105A]  
(Patent Pending)



6' Polaris Quad Bar CLEVIS Rail [CLEVIS-6]  
8' Polaris Quad Bar CLEVIS Rail [CLEVIS-8]



Carboflex Veneered Fiberglass Rail [2204130]



Replacement Rail for Performance Series  
Uneven Bar [P121-99A]



### CAST ANGLE GUIDE [5106-CAST]

- Helps coach and gymnast visualize the angle of the cast based on color coded sections
- Easily attaches to most round apparatus tubes on the market
- Adjustable depending on bars setting to maintain vertical alignment with the rail

|               |     |      |          |
|---------------|-----|------|----------|
| <b>Green</b>  | 15° | from | vertical |
| <b>Yellow</b> | 30° | from | vertical |
| <b>Red</b>    | 45° | from | vertical |



### WALL BRACKET FOR 166SW & 166W PIROUETTE BARS [166WB]

- Wall Bracket for 166SW and 166W Pirouette Bars (set of 2 - shown with the 166W)
- Used to hold the pirouette bar or as a wall bar for conditioning.
- Brackets are available without pirouette bar.



### WIDE PIROUETTE BAR [166SW]

- Fits over a 7.5' wide mat (mat sold separately [434]).
- Bar is made with competition uneven bar rail.

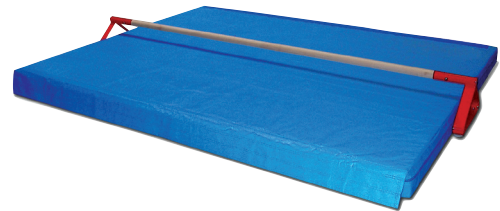

### PORTABLE PIROUETTE BAR [166W]

- The Portable Pirouette Bar is a convenient tool to add a station for bar training.
- Bar is made with solid wooden rail.
- 43 3/4" L x 9 5/8" H



### WOODEN PIROUETTE BAR [166WDPB]

- Bar is made with composite fiberglass rail.
- 51" L x 7 1/4" H



"Loving these new perfectly pink fiber rails that help our little ladies gain confidence while learning to swing. The small diameter is easier to grip. What a valuable tool!"

**KIM ZMESKAL** | 2016 USOC Coach of the Year

**ELLIE BLACK**

2018 Commonwealth Games

Product:  
Soft Touch Balance Beam [1414210]



"The SPIETH Soft Touch beam is great for reducing impact which allows for more repetitions on higher level skills. It adds balance to my training by taking some impact off my body and keeping me excited for some fun on four inches!

Training skills with this beam also allows for familiarity and builds confidence for competitions worldwide."

**ELLIE BLACK** | 2 x Olympian



## INTERNATIONAL "SOFT TOUCH" BALANCE BEAM

[1414210]

**Equipment Features**

- FIG Certified competition model
- Unique top layer technology combining shock absorbing "Soft Touch" landing with excellent stability
- Up to 50% decrease in measured impact forces
- Cover made of skin friendly and moisture absorbing paraskin offers enhanced grip
- Easy height adjustment from 75 to 125 cm in 5 cm increments
- Original System Reuther



## COMPETITION SAFETY PADDING

**1566074** Competition Safety Padding

Custom Landing Mats are Available. See Page 48-51

## COMPETITION PERFORMANCE SERIES CRANK BEAM II

[5121-120]

### Equipment Features

- Only one of its kind in the world meeting FIG and USAG specifications
- Entire beam adjusts with a removable crank handle
- New and improved cover upholstery with bungee cords for increased longevity and optimal cover tension
- New soft caps improve safety
- Continuous height adjustment from 65 cm (25 1/2") to 132 cm (52")
- Angled legs keep base firmly on the floor at lowest setting

**5121-335** 12' Crank Beam also available

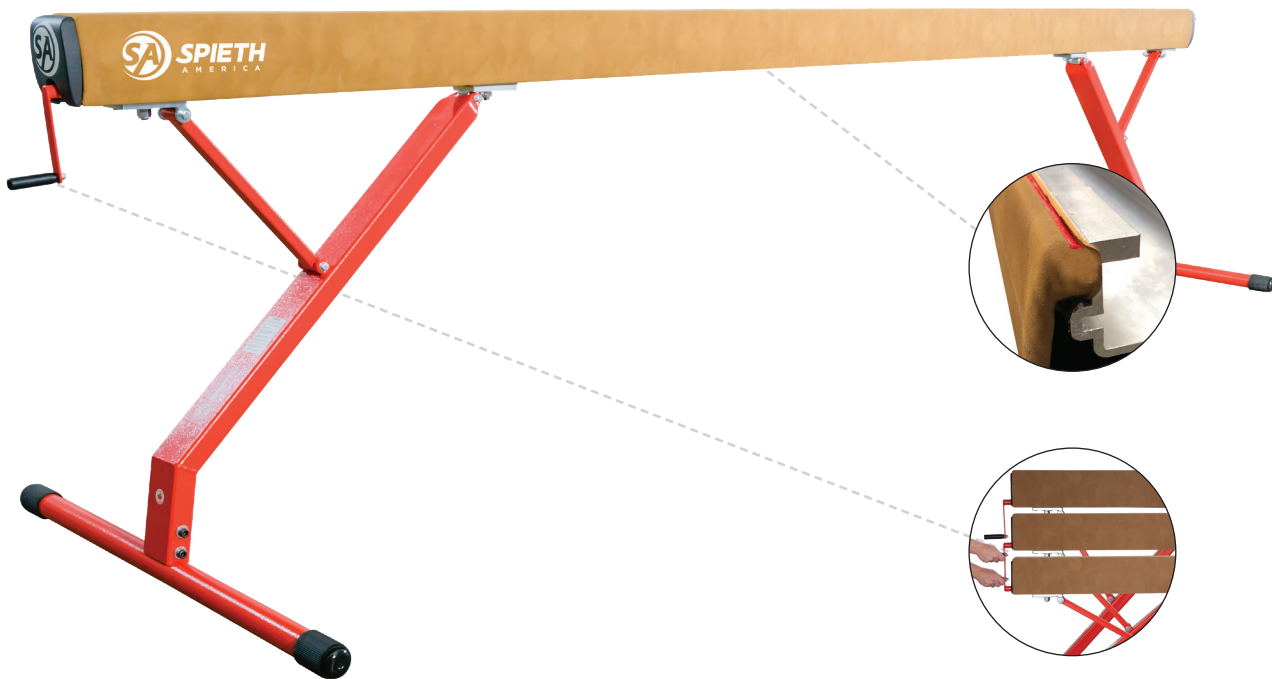

### BALANCE BEAM LEG PADDING

For Crank Beam [5121-120/5121-335]

|                 |  |
|-----------------|--|
| <b>605A</b>     | Beam Leg Upright Pads (pair)                               |
| <b>606-BP12</b> | 12 cm Folding Beam Legs Base padding (Set of 4)            |
| <b>606-BP20</b> | 20 cm Folding Beam Legs Base padding (Set of 4)            |
| <b>606</b>      | Single Cutout Beam Base Pad, 7.5' x 11" x 12 cm (pair)     |
| <b>606I</b>     | Single Cutout Beam Base Pad, 7.5' x 11" x 20 cm (pair)     |
| <b>606-BPVF</b> | Super wide Hook and Loop Flap (for use with 606-BP12 & 20) |
|                 | Double cutout beam base pads also available                |



[606-PO20]

\*Customize padding to fit your gym!

**NEW!**

**RECREATIONAL SA REC BALANCE BEAM**

[REC-5121]

**Equipment Features**

- Reinforced aluminum body with non-slip padded top surface
- Upholstered with bungee cords for increased longevity and optimal cover tension
- Equipped with a quick and easy adjustment for setting the height of the beam
- Combination of cost effectiveness and durability of this balance beam makes it the perfect addition to every gym
- Angled legs keep bases firmly anchored to floor at lowest setting
- Height flawlessly adjusts from 65 cm (25.5") to 132 cm (52")
- Built to FIG specifications



**LOW TRAINING BEAMS**

Our low training beams provide gymnasts an easy transition from the floor to the beam.



[355-151/165]



[118]



[5121-340]

**WIDE TRAINING BEAM**

- 8" W x 86" L x 11" H

**12' STEEL TRAINING BEAM**

- 4" W x 12' L x 13" H
- Light and easy to move around
- Non-adjustable beam legs

**16' COMPETITION TRAINING BEAM**

- 4" W x 16' L x 13" H
- Protective cushioning, length and profile are similar to our crank beam
- Non-adjustable beam legs

## REMOVABLE BEAM COVER (PATENT PENDING)

[GN3652]

### Equipment Features

- Practical way of extending the lifespan of your beam
- Cover attaches using hook-and-loop strips and PVC retaining rings allowing the tension to be adjusted as needed
- Cover is identical to a standard beam body with stretch fabric end caps
- Fresh look without the hassle and expense of other traditional recoveries
- Compatible with different brands of balance beams
- Ideal for stationary beams
- Easy to install

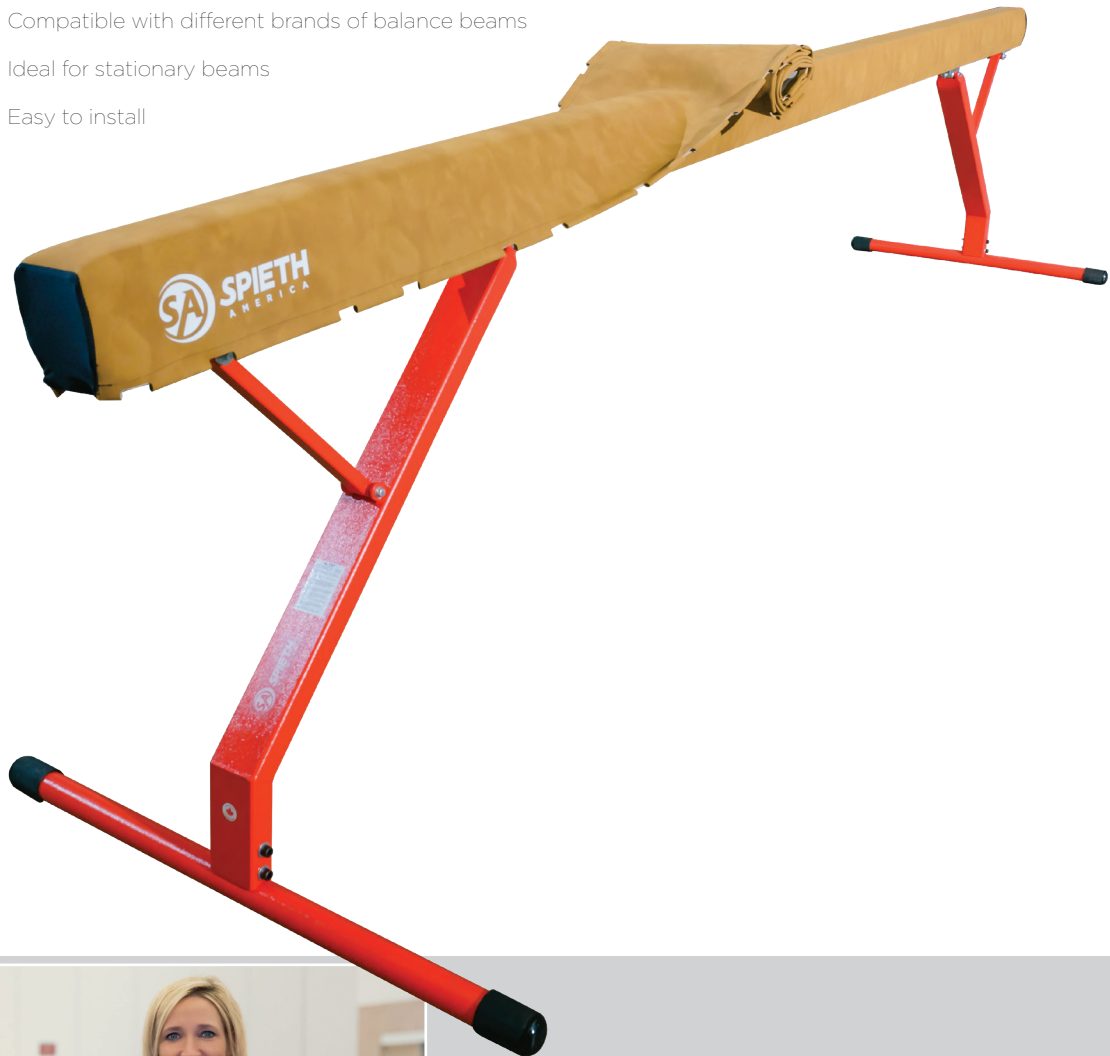

### KIM ZMESKAL APPROVED

Head Coach of Reagan Smith  
at Texas Dreams Gymnastics

"Amazingly impressed with this Spieth America Beam Cover! Fits over any beam, takes less than 30 minutes to install, and has been Reagan's beam of choice since we've had ours!"

MULTI-PURPOSE MAT [5186-001]

- Comprised of supple and shock absorbing foam
- Covered with soft elastic jersey
- Ideal for beam and bars training
- 38" W x 55" L x 3/4" H



BEAM SURFACE EXPANDER [189]

- Can be used on the floor or on any beam meeting FIG specifications
- Essential training tool for every gymnastics program
- Two expanders equal length of competition beam
- 8" W x 8'3" L

**189W** Beam Surface Expander with washable cover (not shown)

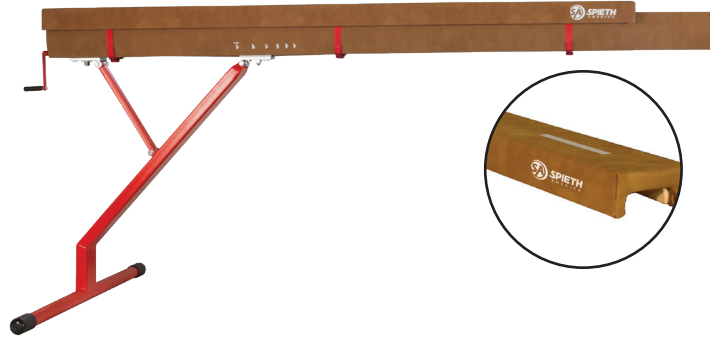

BEAM TRAINING PAD [5126-001]

- Wraps around any beam meeting FIG specifications with hook and loop fastener
- Provides a softer surface for extended training sessions
- 4" W x 42" L x 5/8" H



FOAM LEARNING BEAM [5126-002]

- Comfortable and stable
- Two beams can be linked to each other by hook and loop fasteners
- Includes anti-skid vinyl bottom
- 6"- 9 1/2" W x 98 1/2" L x 4" H



LASER LEARNING BEAM

- Easily transported to various locations
- Very stable
- Clearly marked lines and numbers teach gymnasts how to shift their balance during different phases of various skills
- Includes hook and loop fasteners to connect two units
- 7" W x 2" H

**VTL-DPC-8** 8' Laser beam LITE

**VTL-DPC-16** 16' Laser beam PRO



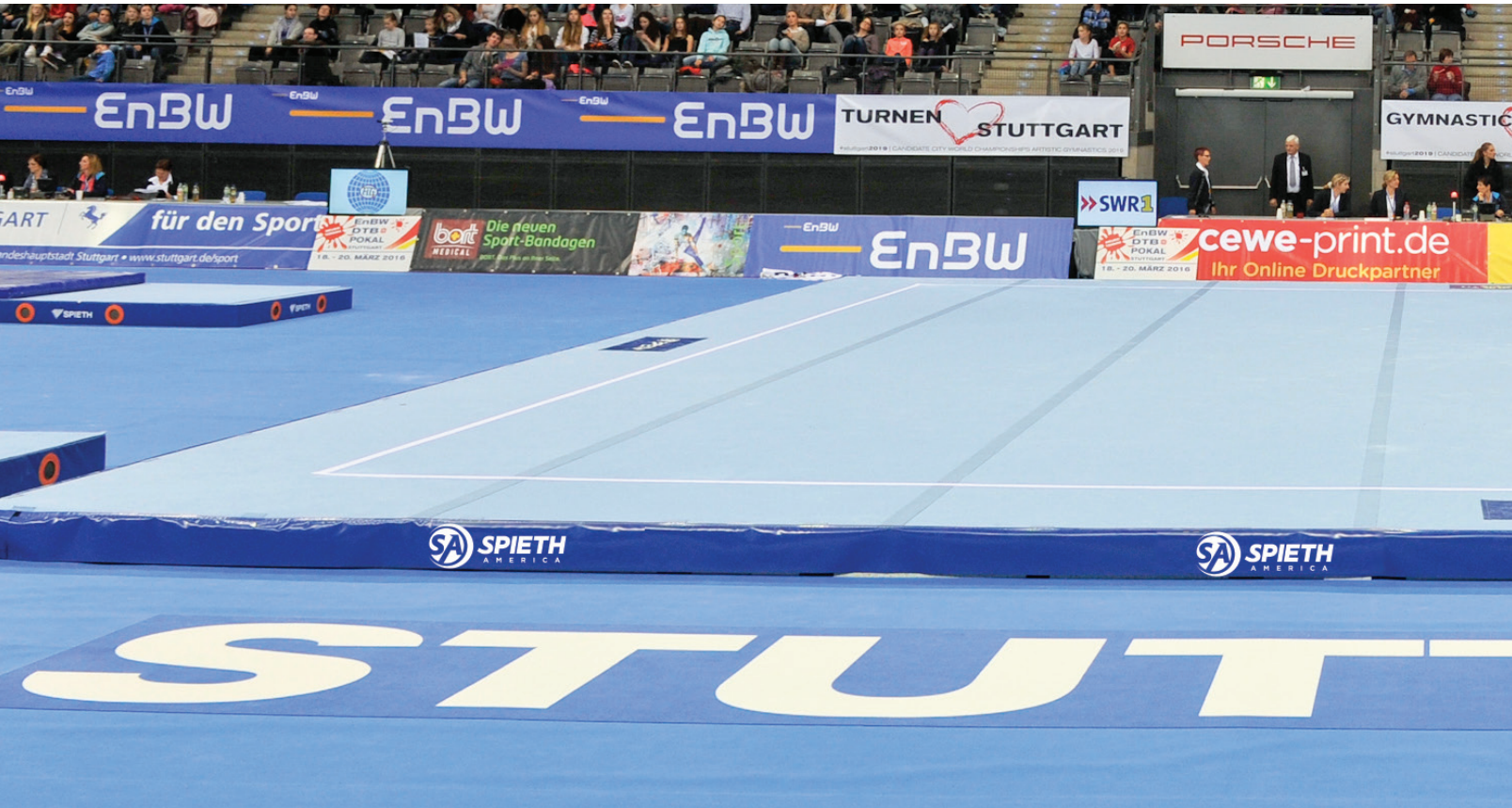

## INTERNATIONAL "MOSCOW" FLOOR EXERCISE

[1790750]



Top international and competition free exercise spring floor with a new 'Spring & Security System'.

Features a very high resilient and fast response time with optimal shock absorption during landing and increased comfort

Sub-construction made of:

- 15 mm high quality finished water resistant coated plywood with new spring system reinforcing optimal rebound
- Resilient coupling strips with tension straps to lock sections
- Seven 14 m x 2 m x 7 cm floor mats covered with needle fleece carpet, linked with 6 "Duo Hook and Loop" straps.
- 14 m x 14 m [1790750] or 13m x 13m [1790759]

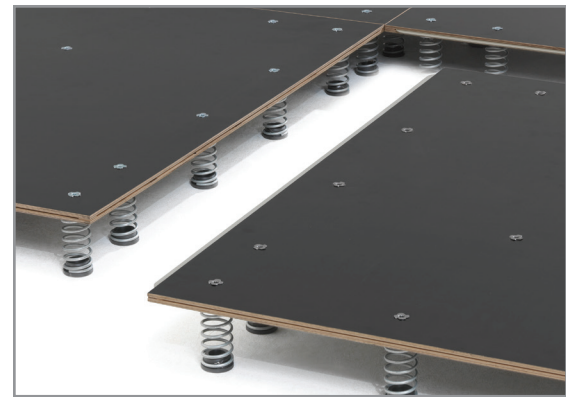

|               |                           |
|---------------|---------------------------|
| <b>159-13</b> | 13m Floor Skirt, set of 4 |
| <b>159-14</b> | 14m Floor Skirt, set of 4 |
| <b>159S</b>   | Custom Floor Skirt        |

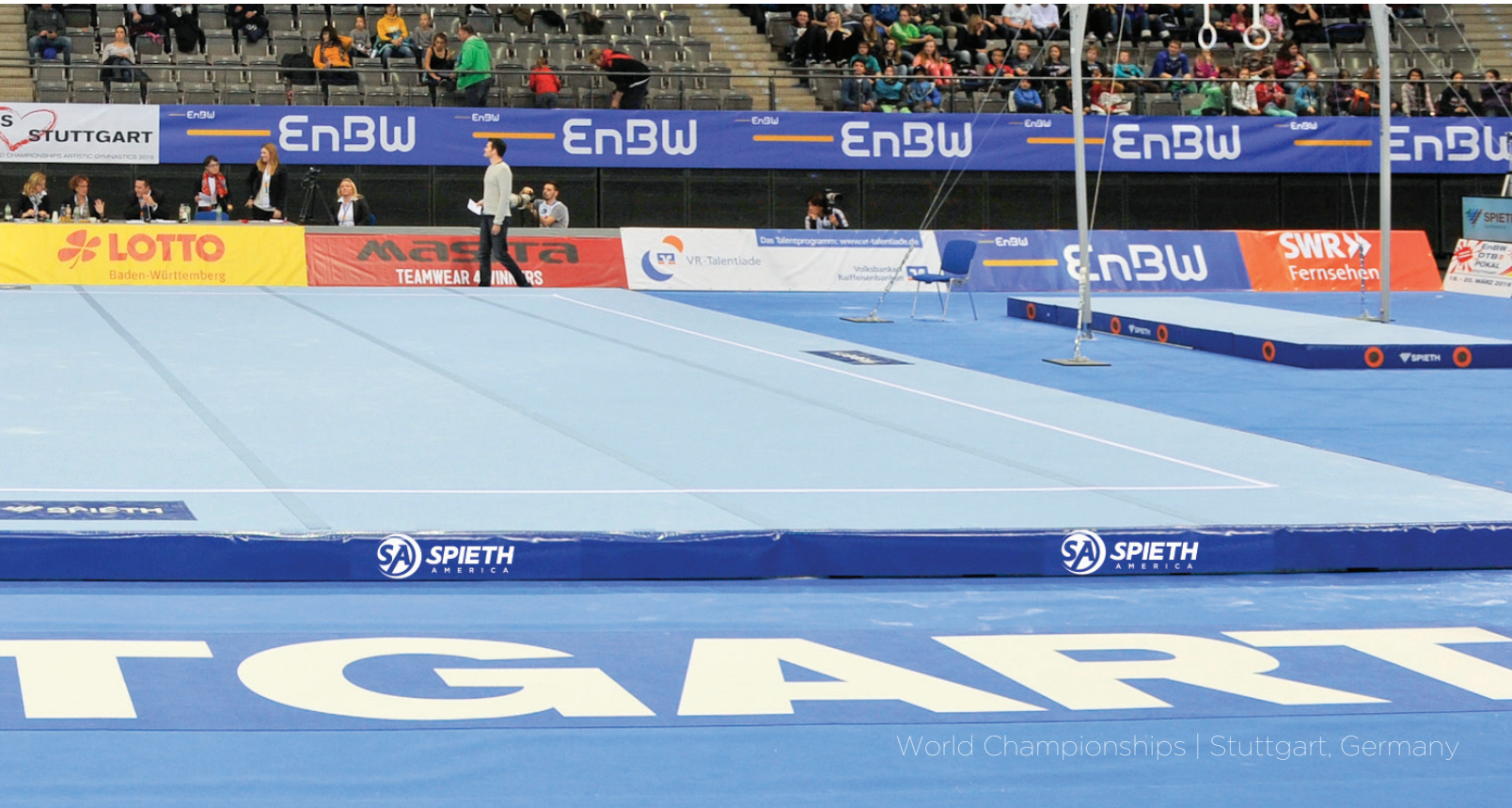

World Championships | Stuttgart, Germany

### CORNER SAFETY MATS

#### 2 LAYER FLOOR

**610** Four pcs. 2' x 4' x 6" & four pcs.. 2' x 6' x 6"

**610USA** Four pcs. 3' x 6' x 6" & four pcs. 3' x 9' x 6"

#### MOSCOW FLOOR

**611** Four pcs. 2' x 4' x 7.5" & four pcs. 2' x 6' x 7.5"

**611USA** Four pcs. 3' x 6' x 7.5" & four pcs. 3' x 9' x 7.5"



### GUSTAVO MOURE

Olympic Coach

"Spieth America equipment collectively is the best of all brands. Spieth products are long lasting and as durable as the brands that have heavy and hard equipment but are also very soft and bouncy like the European brands which add protection to the joints and health of the athletes resulting in a better performance."

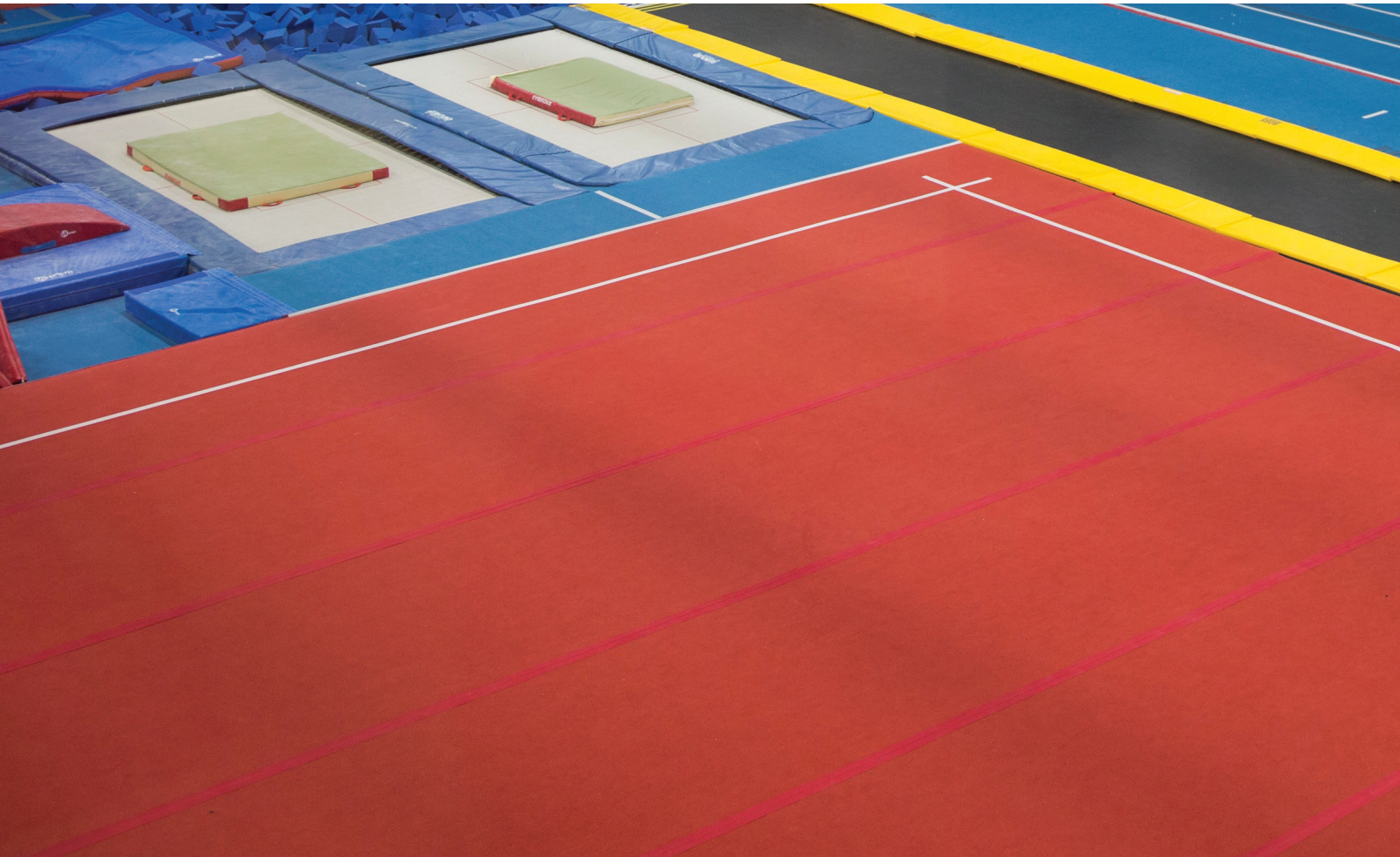

## COMPETITION 2-LAYER SPRING FLOOR

The 2 Layer Spring Floor is an original Spieth Anderson design using top grade springs and premier Russian birch in an overlapping configuration to eliminate soft spots.

### Equipment Features

- 4 1/4" x 2" diameter coil steel springs designed to provide soft compression and maximum lift
- Molded plastic retainer caps on each end help disperse landing impact and protect gym floors
- Springs are evenly positioned on each floor panel
- 42' x 42' floor bottom requires no foam perimeter when used with the standard 7 roll carpet bonded foam floor top





## ARTISTIC GYMNASTICS

**147A-42** 42' x 42' Pre-installed, sprung deck

**147AA-42** 42' x 42' Unsprung deck

## CHEERLEADING

**147C-42** 42' x 54' Cheer Pre-installed, sprung deck

**147CC-42** 42' x 54' Cheer Unsprung deck

## ACCESSORIES

**159** 42' x 42' Floor Skirt, set of 4

**159C** 42' x 54' Floor Skirt, set of 4

**499-WHITE** White Boundary Line

**149A** Coil Springs with hardware - each

**147-55A** 5' x 5' Spring floor section, sprung





**Texas Prime Meet**

Product:  
"Moscow" Floor [1790750]

**Available colors**



**Equipment Features**

- Made with high performance polyethylene sports foam, flame-laminated to high quality carpet
- 6' W x 42' L available in 1 3/8" or 2" thickness
- Available in standard cut or flex-cut rolls
- Each roll includes one 4" roll of hook fastener (one per seam)
- Contact your SA Dealer or Sales Rep. for custom sized rolls

**FLEXI-CUT CARPET ROLLS**

- 138RF** 1 3/8" Flexi-Cut Individual Roll  
6' x 42' x 1 3/8"
- 138RFS** 1 3/8" Flexi-Cut Roll - Custom Length  
6' W x 1 3/8", per square foot
- 138RTFF** Flexi-Cut Tri-Flex with EVA Foam  
6' x 42' x 1 1/2"
- 139RF** 2" Flexi-Cut Individual Roll  
6' x 42' x 2"
- 139RFS** 2" Flexi-Cut Roll - Custom Length  
6' W x 2", per square foot

**STANDARD CARPET ROLLS**

- 138R** 1 3/8" Individual Roll - Blue  
6' x 42' x 1 3/8"
- 138RS** Individual Roll - Custom Length  
6' W x 1 3/8", per square foot
- 138RTF** Individual Roll with EVA Foam  
6' x 42' x 1 1/2"
- 139R** 2" Individual Roll - Blue  
6' x 42' x 2"
- 139RS** 2" Individual Roll - Custom Length  
6' W x 2", per square foot



**HOOK FASTENER ONLY**

Fasteners also available in multiple colors in 50 yard rolls. Contact us for details.

- 499A-BLUE** Blue Hook and Loop 4" x 42'  
Also available in colors shown above



NEW!

AEROBIC & RHYTHMIC GYMNASTICS

AEROBIC FLOOR "BAKU"

The SPIETH aerobic floor "Baku" is an advanced development of the "Ulm" and meets the highest requirements for competition training.



Equipment Features

- The active elasticity and shock-absorption and coordinated in order to reduce impact forces and to protect joints
- Basic panels are connected by means of flexible plastic slats, ensuring an easy and quick installation
- Consists of multi-layer high pressure glued wooden panels with a top layer developed especially for Aerobics.
- 12m x12m, 7.5cm in height

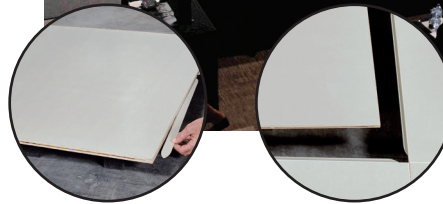
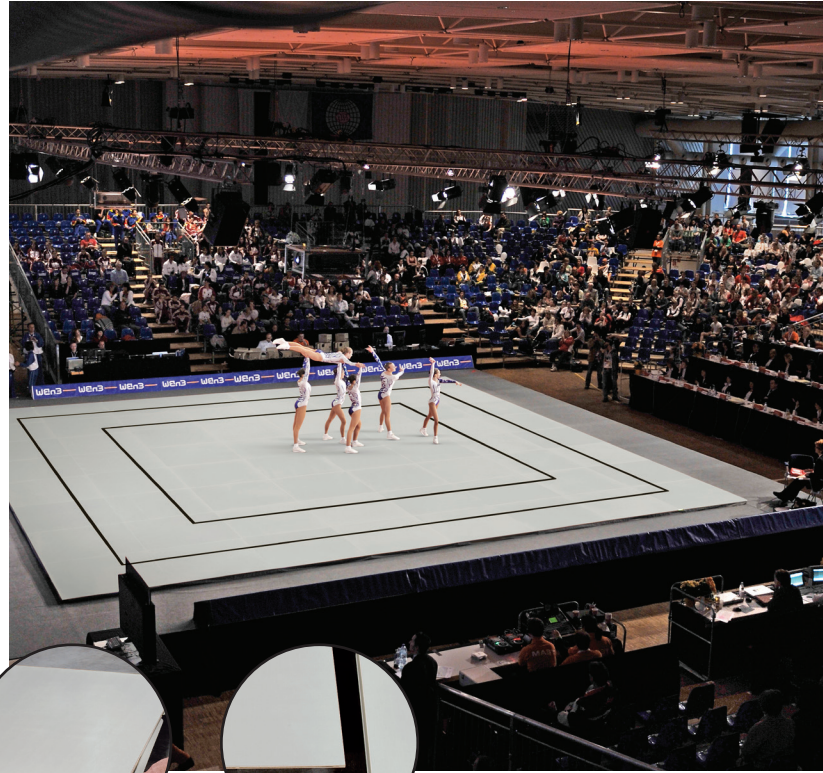

AEROBIC GYMNASTICS

- 147C-42** 42' x 54' Cheer Preinstalled, sprung deck
- 147CC-42** 42' x 54' Cheer Unsprung deck

RG-COMPETITION FLOOR "BEIJING"

Equipment Features

- Shock absorbing substructure is created using 121 panels, covered with compensation panels with additional fiberglass mesh on top. Connected using hook and loop tape.
- Foam elements incorporated for additional shock absorption.
- Includes red boundary hook and loop



RHYTHMIC GYMNASTICS

- 1790580** 14m x 14m RG-Competition Floor "Beijing"
- 1790290** 16m x 16m RG-Competition Floor "Beijing"
- 1790581** 14m x 14m RG-Carpet "Beijing"
- 1790286** 16m x 16m RG-Carpet "Beijing"



**Alberta Gymnastics Federation**

Artistic Provincial Championships

Product:  
Pommel Horse [1406104]



"The Spieth Horse is a phenomenal piece of equipment, very sturdy compared to other brands which helps us gymnasts have more control on such an unpredictable event."

**SAM MIKULAK** | 2 x Olympian

## INTERNATIONAL COMPETITION POMMEL HORSE

[1406104]



### Equipment Features

- Top competition pommel horse
- Stable body upholstered with top quality cowhide leather
- Equipped with two aluminum pommels covered in hygroscopic non-slip rubber
- Includes built-in transport system
- Includes tie-down chain with turnbuckle for floor anchoring
- Height adjusts from 95 cm (37 1/2") to 125 cm (49 1/4") in 5 cm (2") increments
- Used at 2016 Rio Olympic Games



Height Adjustment System



Built-in Transportation System

## COMPETITION SAFETY PADDING

1566064 Competition Safety Padding [sold as a pair]

Custom Landing Mats are Available. See Page 48-51



See all Mens Training Aids on Pages 46 & 47

**RECREATIONAL POMMEL HORSE**

[REC-5141]



**Equipment Features**

- Designed and built to FIG pommel horse specifications.
- Stable body upholstered with top quality micro-fiber leather
- Equipped with two wood pommels
- Includes tie-down chain for floor anchoring
- Height adjusts from 100 cm to 135 cm in 5 cm increments

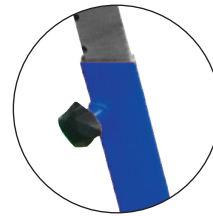

Height Adjusting System



Micro-Fiber Leather Pommel Top



**THOMAS FLAIR APPLIANCE** [1403210]

- Lines run through pulleys from one foot to the other ensuring correct movements
- Adjustable foot loops
- Adjustable width
- Can be hung anywhere

## JUNIOR POMMEL HORSE [1407068]

[1407068]

### Equipment Features

- Designed for the physique of young gymnasts: height body size and pommels are smaller by 90% in comparison
- Helps prevent poor posture, incorrect stress and injuries
- Leather covered body
- Height 100 cm (39 1/4"), Body 142 x 32 cm (55 3/4" x 12 1/2")
- For athletes up to 14 years old



Wooden Pommel Holds



Leather Pommel Top

100 %



90 %



## DOUBLE POMMEL TRAINER [1403314]

- Helps transition from mushroom to horse.
- Leather-covered body
- Includes competition pommels
- Large rubber covered base for optimum stability
- Does not require extra rubber edging no floor damage



See all Mens Training Aids on Pages 46 & 47

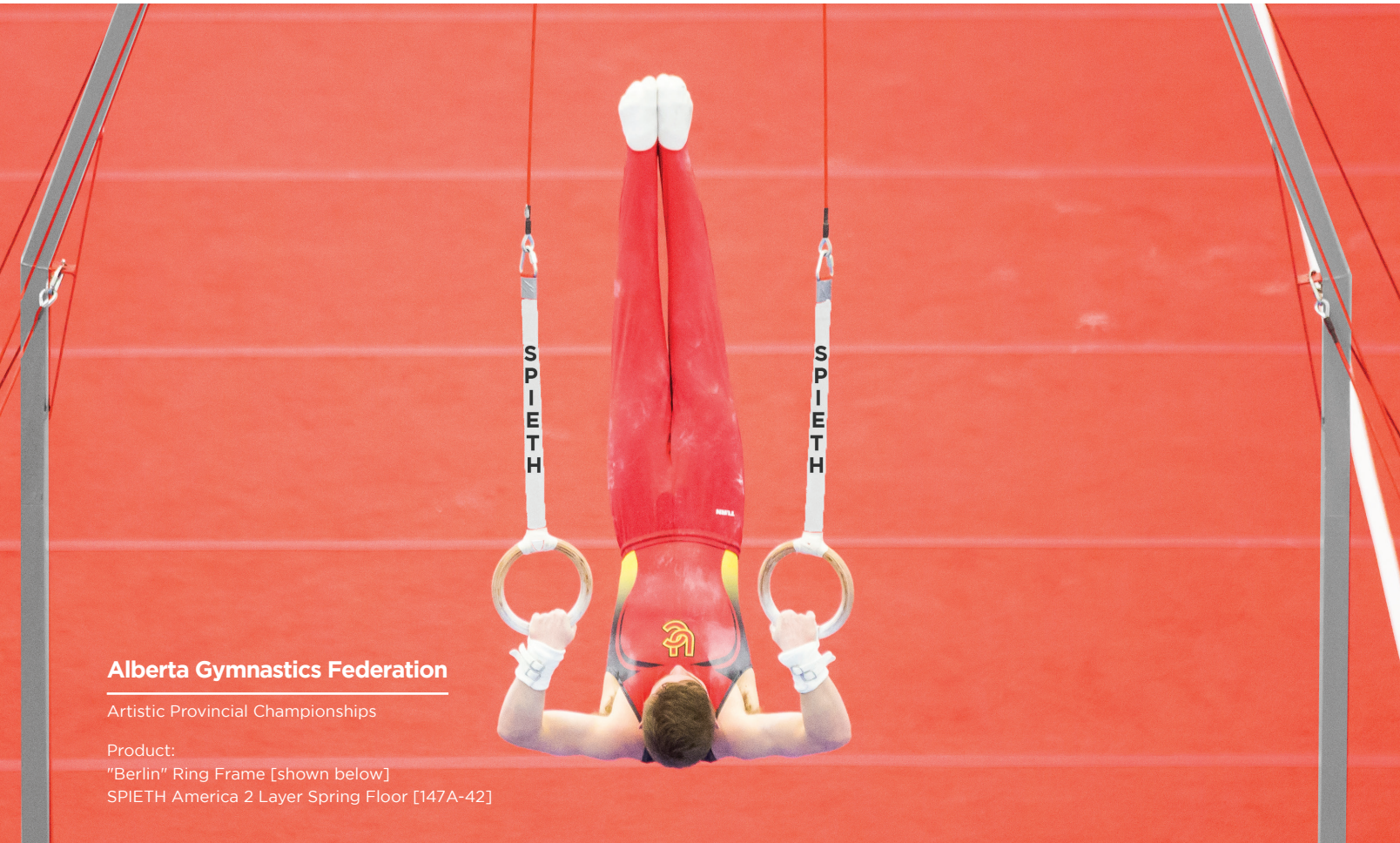

## Alberta Gymnastics Federation

Artistic Provincial Championships

Product:

"Berlin" Ring Frame [shown below]

SPIETH America 2 Layer Spring Floor [147A-42]

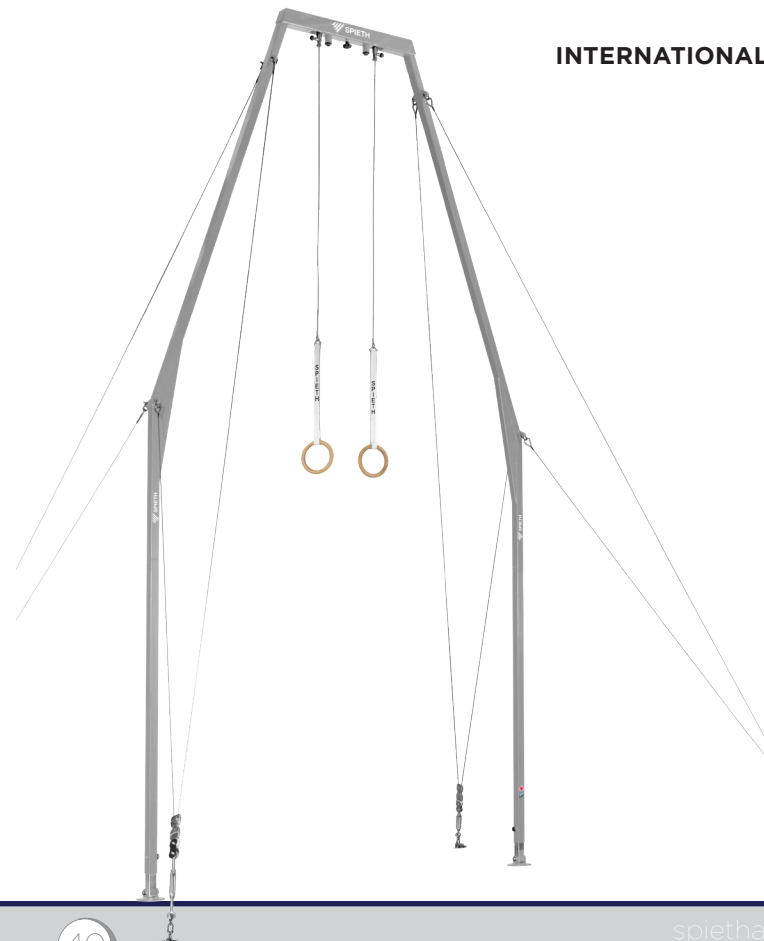

## INTERNATIONAL "BERLIN" RING FRAME

[1384034]



### Equipment Features

- Improved frame and double tensioning system
- Unique shock absorption system reduces impact on joints and peak forces
- Plywood rings, heavy duty straps and steel plastic-encased cables
- Height adjusts from 275 cm ( 108 1/4") to 302.5 cm (119") in 2.5 cm (1") and 5 cm (2") increments
- Minimum ceiling height required is 620 cm (20'4")
- Used at 2016 Rio Olympic Games





**NEW!**

**RECREATIONAL SA REC RING FRAME**  
[REC-5151]

**Equipment Features**

- Light weight, easy to assemble and transport
- Includes rubber shock absorbers to reduce impact on athletes' shoulders and back
- Plywood rings attach to non-stretch straps, with plastic encased aircraft grade cables.

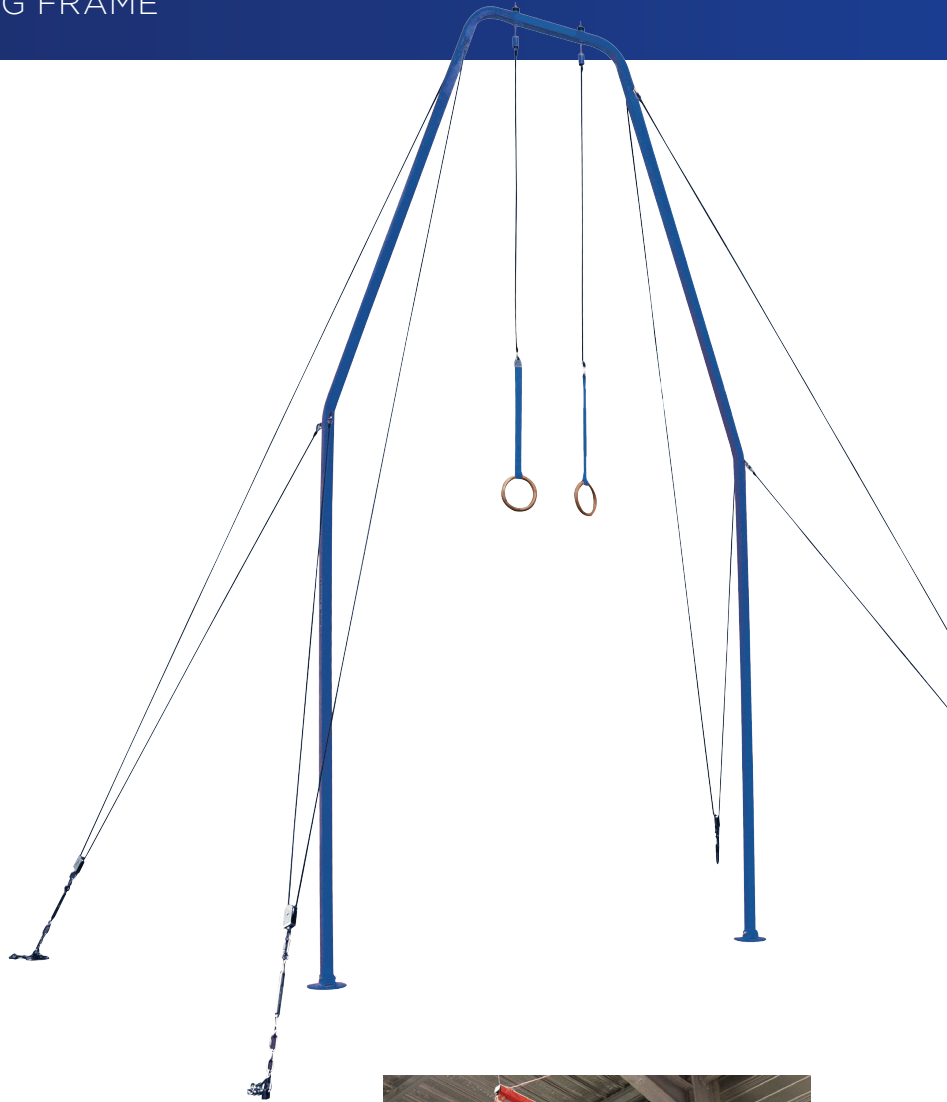

**WALL MOUNTED RINGS [GN3750]**

- Wall mounted, folds away sideways
- Height adjusts from 20 cm (8") to 280 cm (110 1/4")
- Rings included



**CEILING HUNG RINGS [108]**

- Ideal solution for limited space
- Includes a pair of swivels, cables and heavy duty nylon straps with plywood rings
- Attaches to beam clamps (Sold separately [1101])



# INTERNATIONAL MELBOURNE PARALLEL BARS

[1403110]



### Equipment Features

- Stable in all directions
- Patented 2 fold secured clamping jaw lock
- Pretensioned high frequency rails with veneer finish [included] provide optimal resilience and equal elasticity
- Height adjustment from 160 cm (63") to 210 cm (82 1/2") in 5 cm (2") increments
- Width adjustment from 41 cm (15 3/4") to 71 cm (27 1/2") continuously
- Is used at the 2019 World Artistic Gymnastic Championships in Stuttgart Germany



Height Adjusting Locking System



Nickle-Plated Sliding Tubes and Cast-Iron Precision Clamp



"The Spieth Parallel Bars are my favorite bars of all time, grip is so much easier on the wooden rails and the bounce of them give way more room for high flying elements.

The changing of the width is so much easier with the pull and twist handles as well, making efficient prep time when you only have a minute before a competitive routine"

**SAM MIKULAK** | 2 x Olympian

**NEW!**

**RECREATIONAL SA REC PARALLEL BARS**  
[REC-5161]

**Equipment Features**

- Designed for all competition levels
- Pretensioned high frequency glued wood rails with fiberglass inserts provide optimal resilience and equal elasticity
- Height adjusts from 165 cm (67 3/4") to 210 cm (82 2/3") in 5 cm (2") increments
- Width adjusts from 40 cm (15 3/4") to 70 cm (27 1/2")

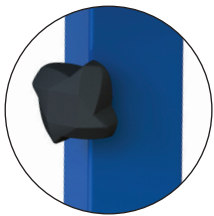

Height Adjusting Locking System



Height Adjusting Handle

**STEEL PARALLEL BAR TRAINERS**

- Extremely stable but lightweight and easy to move
- Includes protective footpads
- Shown with optional base padding (165-LBP).

**165-12** 18" W x 12" H

**165-18** 18" W x 18" H

**165-24** 18" W x 24" H



See all Mens Training Aids on Pages 46 & 47

## Alberta Gymnastics Federation

Artistic Provincial Championships

Product:  
"Stuttgart" Horizontal Bar [1384214]



"The Spieth High Bar is the best in the business. The bounce of the bar is very reliable for the big releases giving us athletes all the more confidence when in a high pressure situation."

**SAM MIKULAK** | 2 x Olympian

**INTERNATIONAL "STUTTGART" HORIZONTAL BAR**

[1384214]



**Equipment Features**

- Includes "break-proof" stainless steel rail with built-in pretensioned steel cable
- Reduces vibrations by half and provides a predictable reaction on dismount
- Rail tension is consistent, even with normal wear
- Height adjusts from 265 cm (104 1/4") to 310 cm (122") in 5 cm (2") increments
- Used at 2016 Rio Olympic Games



"Break-Proof" Stainless Steel Rail

**NEW!**

**RECREATIONAL SA REC HIGH BAR**

[REC-5171]

**Equipment Features**

- Includes two rotation axis rail heads designed to provide a perfectly jolt free "gimbal" effect
- Easy to assemble and dismantle via load binders
- Height adjusts from 275 cm to 315 cm
- Anti-slip footpad

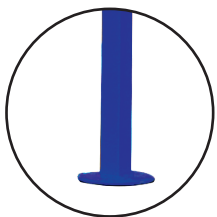

Anit-Slip Footpad

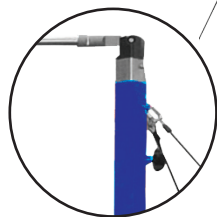

Rotation Axis Rail Heads

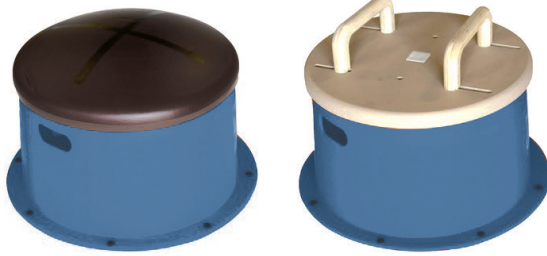

## ULTRA DOMES

- Excellent training tool for beginner level athletes
- Stable but light enough to move around the gym for training station
- 30" Diameter x 13" H

**GT-100** Ultra Dome without Pommel

**GT-200** Ultra Dome with Pommel



## EUROPEAN POMMEL TRAINER [1395024]

- Mushroom 100 cm (39.25") without pommel
- Functional grip
- Seamless
- Ergonomic shape
- 48 cm high
- Promotes correct leg position



## SINGLE POMMEL TRAINER [1395018]

- Mushroom 60 cm (23 1/2") with one synthetic pommel
- Functional grip
- Ergonomic shape
- 48 cm (18 3/4") high
- Promotes correct leg position



## DOUBLE POMMEL TRAINER [1403314]

- Helps transition from mushroom to horse
- Leather-covered body
- Includes competition pommels
- Large rubber covered base for optimum stability
- Does not require extra rubber edging, no floor damage



## HANDSTAND BOWL [1384168]

- Training aid for rings handstand
- Next phase following the handstand swing
- Grips in correct position for rings
- For perfecting the stance
- Simple correction by the trainer
- Moves in all directions
- Can be used as a dome



## HANDSTAND SWING [1384164]

- Training aid for rings handstand
- Next phase following the wooden handstand aids
- Grips in correct position for rings
- For perfecting the stance
- Simple correction by trainer
- Moves in one direction only



**FIFTY-FIFTY EQUIPMENT**  
[1403250]

- Includes pulley set, cord and rings
- Promotes faster and easier training of ring positions
- Facilitates training assistance
- Ideal for methodical training
- For use with Somersault Belt and ceiling fixation (sold separately)



**PORTABLE RINGS**  
[1384175]

- With straps to hang onto parallel bar rails
- Straps' height is adjustable
- Ideal for methodical training



**BEAM CLAMP**  
[1101]

- Fits I-Beams and open web joists from 3 7/8" to 13 1/2" and up to 3/8" thick
- Sold individually
- Supports ceiling hung rings (sold separately [108])

**STEEL PARALLEL BAR TRAINERS**

- Extremely stable but lightweight and easy to move
- Includes protective footpads
- Shown with optional base padding (165-LBP).

**165-12** 18" W x 12" H

**165-18** 18" W x 18" H

**165-24** 18" W x 24" H

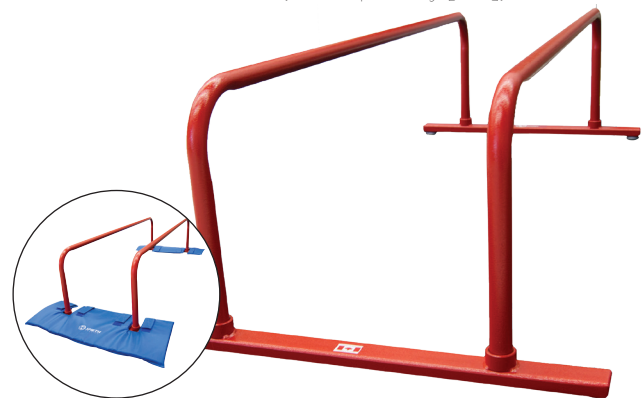

**FOAM PARALLEL BAR TRAINER** [167]

- Beginner tool for the development of competition parallel bars
- Yellow portion indicates rail area
- Each block is 24" W x 48" L 48" H



**WIDE PIROUETTE BAR** [166SW]

- Fits over a 75' wide mat (mat sold separately [434]).
- Bar is made with competition uneven bar rail.



**PORTABLE PIROUETTE BAR** [166W]

- The Portable Pirouette Bar is a convenient tool to add a station for bar training.
- Bar is made with solid wooden rail.
- 43 3/4" L x 9 5/8" H





### FIG Designed International Landing Mats - For Use in Mat Sets

These high-quality mats are designed to be used in a set with our INTERNATIONAL apparatus line of products in order to meet the FIG Standards for competition landing set ups. Contact us for COMPETITION apparatus line mat sets.

|                 |   |
|-----------------|---|
| <b>5181-021</b> | 2 m (6.5') x 1 m (3.3') x 20 cm, Hook and Loop pile on 4 sides, non-folding                     |
| <b>5181-022</b> | 2 m (6.5') x 2 m (6.5') x 20 cm, Hook and Loop pile on 4 sides, non-folding                     |
| <b>5181-023</b> | 2 m (6.5') x 3 m (9.8') x 20 cm, Hook and Loop pile on 4 sides, non-folding                     |
| <b>5181-225</b> | 2 m (6.5') x 2.5 m (8.2') x 20 cm, Hook and Loop pile on 2 sides, non-folding                   |
| <b>5182-024</b> | 2 m (6.5') x 4 m (13.1') x 10 cm, non-folding   |
| <b>5182-026</b> | 2 m (6.5') x 6 m (19.7') x 10 cm, non-folding<br>(Includes FIG Standards landing zone markings) |

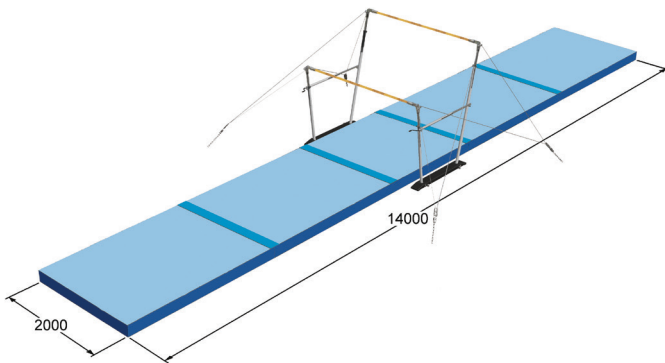

#### UNEVEN BAR MAT SET [5181-100]

14 m (45.9') x 2 m (6.5') x 20 cm configuration, includes:

- 1 - #5181-022
- 4 - #5181-023
- Hook and Loop flaps for attachment

**5181-110** Full FIG Mat Standard configuration #5181-100 Mat Set with #5182-024 supplementary mat

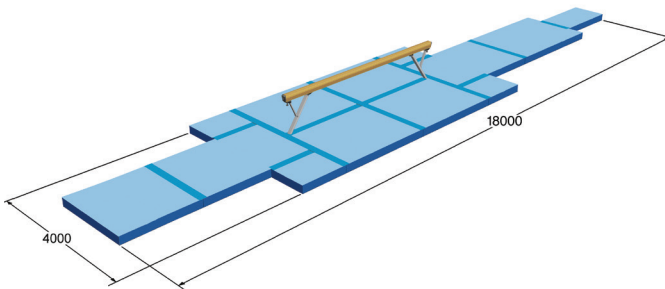

#### BALANCE BEAM MAT SET [5181-200]

18m (59') x 4m (13.1') x 20 cm configuration, includes:

- 4 - #5181-022 (special, with cut-outs for beam legs)
- 3 - #5181-023
- 1 - #5181-022
- 4 - #5181-011
- 1 - #5181-021
- Hook and Loop flaps for attachment

**5181-210** Full FIG Mat Standard configuration #5181-200 Mat Set with #5182-024 supplementary mat

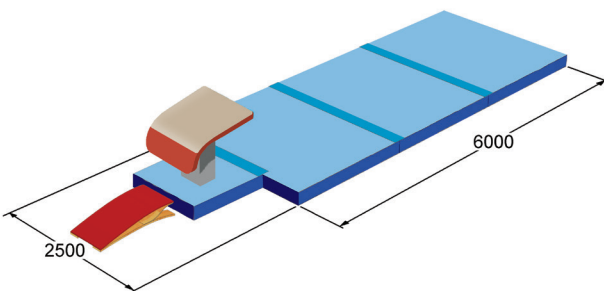

#### VAULT MAT SET [5181-300]

6m (19.7') x 2.5m (8.2') x 20 cm configuration, includes:

- 3 - #5181-225
- Hook and Loop flaps for attachment

**5181-310** Full FIG Mat Standard configuration #5181-300 Mat Set with #5182-026 supplementary mat



### HORIZONTAL BAR MAT SET [5181-600]

12 m (39.4') x 3 m (9.8') x 20 cm configuration, includes:

- 6 - #5181-023
- Hook and Loop flaps for attachment

**5181-610** Full FIG Mat Standard configuration #5181-600 Mat Set with #5182-024 supplementary mats

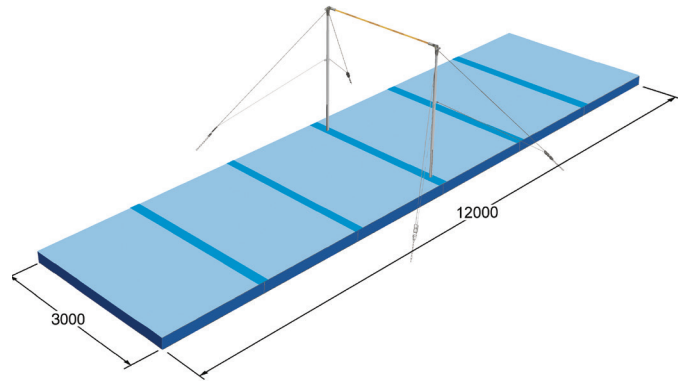

### PARALLEL BAR MAT SET [5181-500]

11 m (36.1') x 4.7 m (15.4') x 20 cm configuration, includes:

- 4 - #5181-023
- 4 - #5181-113
- 1 - #5181-021
- 1 - #5181-307
- Hook and Loop flaps for attachment

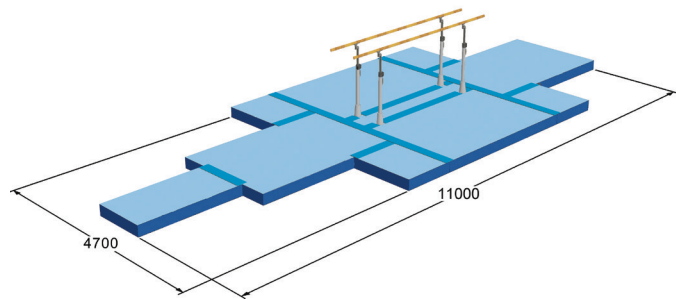

### RING MAT SET [5181-400]

5 m (16.4') x 2 m (6.5') x 20 cm configuration, includes:

- 1 - #5181-023
- 2 - #5181-021
- Hook and Loop flaps for attachment

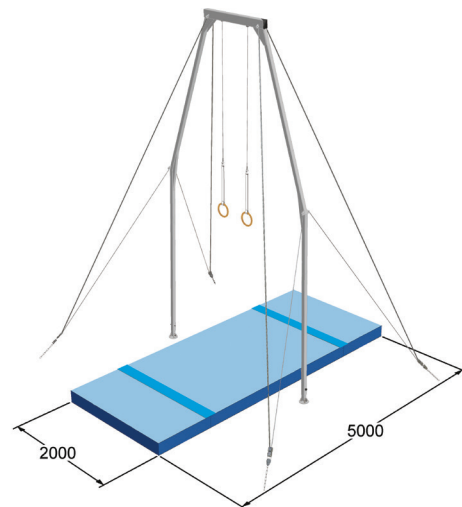

### POMMEL HORSE MAT SET [5183-100]

4 m (13.1') x 4 m (13.1') x 10 cm configuration

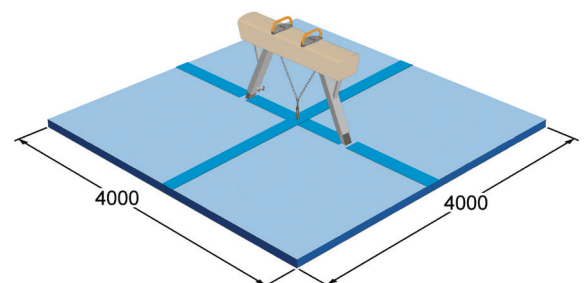



### Ice Challenge Invitational

Midland Gymnastics Training Center  
Midland, MI

Product:  
All American Uneven Bars [5101-120]

[See page 84-89 for Meet Rentals]

#### HOOK AND LOOP ENDS ONLY, FOLDING

- 435** 7.5' x 12' x 12 cm

---

- 424** 7.5' x 15.5' x 12 cm

---

- 412** 8' x 15.5' x 12 cm

---

- 427** 7.5' x 12' x 20 cm

---

- 429** 7.5' x 15.5' x 20 cm

---

- 425** 8' x 15.5' x 20 cm

#### HOOK AND LOOP FLAPS

- 410VF** 7.5' L x 10" W

---

- 435VF** 12' L x 10" W

---

- 424VF** 15.5' L x 10" W

---

- GPMVF** Custom Length x 10" W

#### HOOK AND LOOP ENDS ONLY, NON-FOLDING

- 435Q** 7.5' x 3' x 12 cm

---

- 435H** 7.5' x 6' x 12 cm

---

- 434** 7.5' x 10'8" x 12 cm

---

- 413** 8' x 4' x 12 cm

---

- 427Q** 7.5' x 3' x 20 cm

---

- 427H** 7.5' x 6' x 20 cm

---

- 431** 8' x 4' x 20 cm

#### CARPET BONDED FOAM LANDING MATS

Made to order. Call for pricing.

#### HOOK AND LOOP 4 SIDES

- 435V4S** 7.5' x 12' x 12 cm, Folding

---

- 424V4S** 7.5' x 15.5' x 12 cm, Folding

---

- 427QV4S** 7.5' x 3' x 20 cm

---

- 427HV4S** 7.5' x 6' x 20 cm

---

- 427V4S** 7.5' x 12' x 20 cm, Folding

---

- 429V4S** 7.5' x 15.5' x 20 cm, Folding



#### TRAINING MATS

- 448** 5' x 10' x 4"

---

- 448AS** 5' x 10' x 4" *anti-skid*

---

- 417** 5' x 10' x 8"

---

- 417AS** 5' x 10' x 8" *anti-skid*

---

- 417T** 5' x 10' x 8" *tapered end*

---

- 470** 7' x 10' x 8"

---

- 442** 6' x 12' x 12"

## THROW MATS

- Cushioned landings
- Use in conjunction with other mats
- Non-folding



|     |   |
|-----|---|
| 446 | 4' X 6' X 2" [mesh top]                         |
| 447 | 4.5' x 8' x 4" [mesh top]                       |
| 419 | 7' x 10' x 4" [vinyl top with one mesh side]    |
| 420 | 6.5' x 9.8' x 4" [vinyl top with one mesh side] |

## STING MATS

The Sting Mats are covered with our **extra soft** 18oz. brushed denim. Non-folding.



|        |                     |
|--------|---------------------|
| 444    | 3.25' x 6.5' x 2"   |
| 444-15 | 3.25' x 6.5' x 1.5" |
| 445    | 6.5' x 10' x 2"     |
| 445-15 | 6.5' x 10' x 1.5"   |

## SOFT IMPACT MATS & PIT MODULES

- Great as a trampoline throw mat
- Can be used in a loose foam pit
- Made with polyurethane foam covered with **extra soft** 18 oz. brushed denim



|           |                              |
|-----------|------------------------------|
| SIM-466   | 4' x 6' x 6"                 |
| SIM-568   | 5' x 6' x 8"                 |
| SIM-6812  | 6' x 8' x 12"                |
| STPM51024 | Soft Top Pit, 5' x 10' x 24" |
| STPM61224 | Soft Top Pit, 6' x 12' x 24" |

## PANEL MATS

Available Sizes in 1.25" or 2":

- 2" hook and loop available on ends or on all four sides
- Available without hook and loop
- Made with polyethylene foam
- Light weight and easy to store
- All mats fold in 2' wide panels
- Fully customizable

|          |
|----------|
| 4' x 4'  |
| 4' x 6'  |
| 4' x 8'  |
| 5' x 10' |
| 6' x 12' |

|           |        |            |        |
|-----------|--------|------------|--------|
| RED       | ORANGE | YELLOW     | GREEN  |
| DARK BLUE | BLUE   | LIGHT BLUE | PURPLE |
| PINK      | WHITE  | GRAY       | BLACK  |



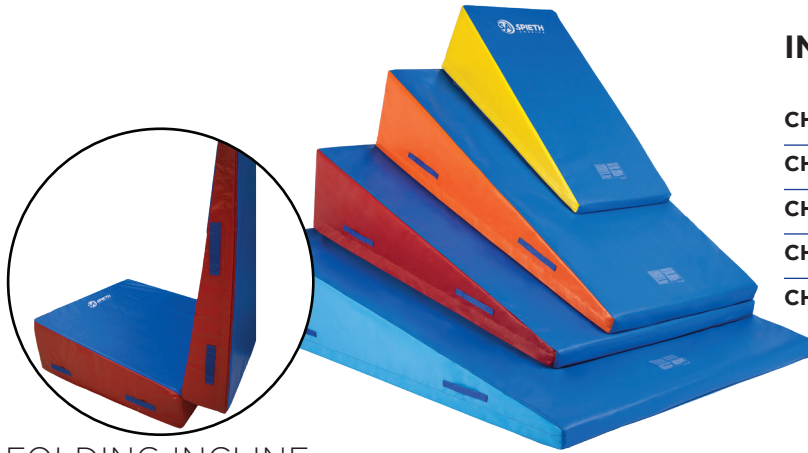

FOLDING INCLINE  
[CHFI-1]

## INCLINE MATS

|               |  |
|---------------|--|
| <b>CHIM-1</b> | 24" W x 48" L x 14" H, Blue/Yellow   |
| <b>CHIM-2</b> | 36" W x 72" L x 16" H, Blue/Orange   |
| <b>CHIM-3</b> | 48" W x 72" L x 16" H, Blue/Red  |
| <b>CHIM-4</b> | 60" W x 84" L x 18" H, Blue & Light Blue                                     |
| <b>CHFI-1</b> | Folding Incline,<br>60" W x 120" L x 22" H<br>folds to 60" W x 60" L x 24" H |

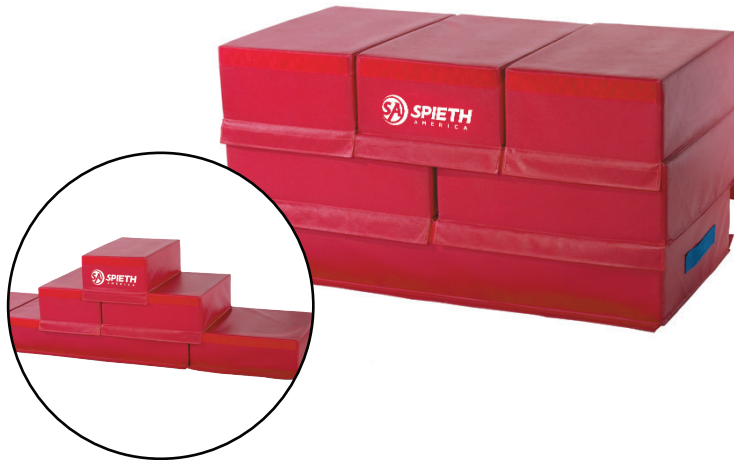

## MULTI-BLOCK [CSB-2]

- Versatile and stackable, these blocks offer functional, multi-use possibilities at all levels
- Can be used as spotting platforms in the formation of steps, pyramids, raised stretching platforms, award podiums, location stations, obstacle courses, and more
- Overall size: 24" W x 48" L x 24" H

### Includes:

- 3 24" W x 16" L x 8" H blocks
- 2 24" W x 24" L x 8" H blocks
- 1 24" W x 48" L x 8" H block



## TRAPEZOIDS

|              |  |
|--------------|--|
| <b>CVB-1</b> | Trapezoid<br>36" W (at the base) x 48" L x 48" H                       |
| <b>CVB-2</b> | Junior Trapezoid<br>30" W (at the base) x 36" L x 36" H                |
| <b>CVB-3</b> | Trapezoid with 3 Piece Top Tier<br>36" W (at the base) x 48" L x 48" H |

[CVB-1]

[CVB-3]

## DIVIDER WALLS & DOOR

- CWD-1**     Divider Wall

---

- CWD-2**     Divider Door

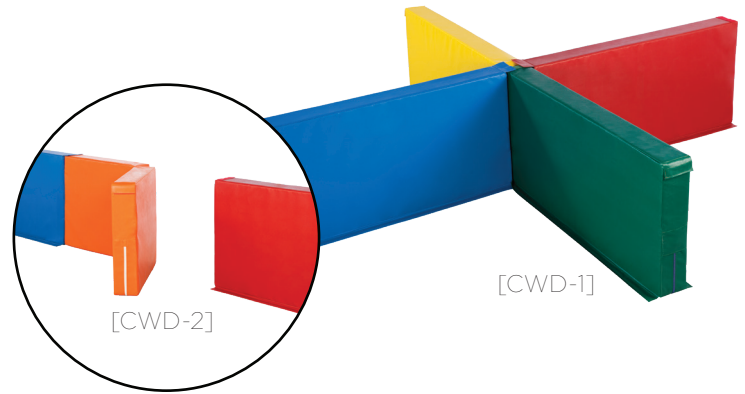

## OCTAGONS

- CCOST-1**     15" x 24" | Blue/Yellow

---

- CCOST-2**     20" x 28" | Blue/Orange

---

- CCOST-3**     25" x 36" | Red/Blue

---

- CCOST-4**     30" x 36" | Blue/Light Blue



## HANDSPRING TRAINERS

- CHT-36**     36" Handspring Trainer | Blue/Orange  
Suggested for athletes 53"- 60"

---

- CHT-40**     40" Handspring Trainer | Blue/Red  
Suggested for athletes 61"- 68"



## THE BOULDER® HANDSPRING TRAINER

[NAP-D-JL-135K]

- Stands ready for use and automatically returns to standard position after each use
- Properly supports user throughout the full motion
- Begins rolling only when user correctly transfers weight
- Encourages user to "snap down"
- Does not prematurely eject user
- Never rolls over or on top of user



[S1740521]

[S1740520]



[S1740500]

[S1740501]

[S1740511]

[S1740510]

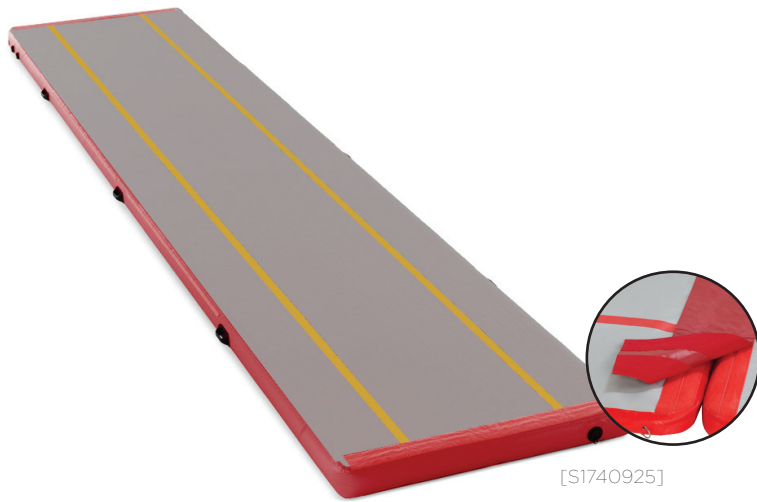

[S1740925]

## AIR TRACKS

**S1740925** 49' (15 m) x 6 1/2' (2 m) x 8" (20 cm)

**S1740926** 33' (10 m) x 6 1/2' (2 m) x 8" (20 cm)

**S1740927** 33' (10 m) x 6 1/2' (2 m) x 12" (30 cm)

## HOOK AND LOOP FLAP [INFL-VF]

Easily connects to Inflatable products together.

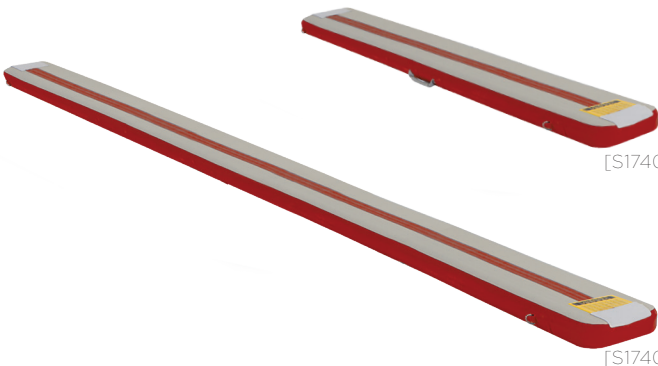

[S1740522]

[S1740523]

## AIR MAT BEAM

**S1740522** 40 cm (15 3/4") x 300 cm (9'10") x 10 cm (4")

**S1740523** 40 cm (15 3/4") x 500 cm (16'5") x 10 cm (4")

## AIR MAT FLOORS

Teaching aid (for e.g. balance beam) and provides greater comfort for floor exercises

|                 |                                      |
|-----------------|--------------------------------------|
| <b>S1740511</b> | Short - 6.5' x 3.25' x 10 cm         |
| <b>S1740512</b> | Medium - 10' x 6.5' x 30 cm          |
| <b>S1740510</b> | Long - 13' x 6.5' x 10 cm            |
| <b>S1740521</b> | Incline - 3' W x 4' L x 30 - 10 cm H |
| <b>S1740520</b> | Cylinder - 3 1/4' W x 2 2/3' D       |
| <b>S1740500</b> | Square                               |
| <b>S1740501</b> | Board                                |
| <b>1740110</b>  | Air mat/Air floor Pressure Gauge     |

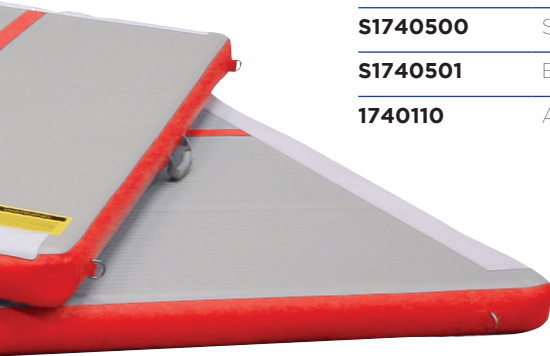

Comfortable training for floor exercises, uneven bars and parallel bars

- Inflates in seconds, with adjustable pressure level
- Easier on joints, to increase practice time
- For beginners and top gymnasts
- Lines are clear to both gymnast and trainer for correction purposes
- Air blower sold separately

## MINI AIR BLOWER FOR AIR TRACKS [S1740076]

It is recommended to use two Mini Blowers for one Air Track. Light-weight easy to transport, rapid inflation and deflation at 250 m Bar maximum pressure with maximum flow-rate of 2000 L/min; weighs 3.75 lbs.



## MINI AIR BLOWER FOR AIR MAT PRODUCTS [S1740115]

Compact blower for air products. Light-weight easy to transport, rapid inflation and deflation at 250 m Bar maximum pressure with maximum flow-rate of 1700 l/min; weighs 3.75 lbs. Fitted with a thermal cut-out and the adapter for the air products is included.



## AIR MAT/AIR FLOOR PRESSURE GAUGE [1740110]

Clear display of air pressure. Comes with a storage bag.





**INTERNATIONAL**

**"MOSCOW" TUMBLING TRACK**

- New 'Spring and Security System' optimizes rebound
- High performance base with tensioning straps to lock the sections in place
- High quality foam layer for fast response and increases landing comfort
- Height of 20 cm and connects to our Moscow floor for perfect integration
- Suitable for all ages and performance levels

|                |                   |
|----------------|-------------------|
| <b>1790762</b> | 12 m, 10 elements |
| <b>1790770</b> | 14 m, 12 elements |
| <b>1790760</b> | 18 m, 15 elements |

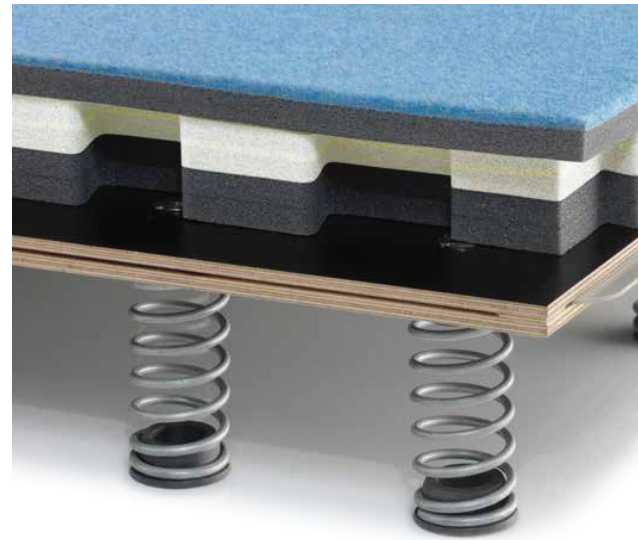

**TUMBLING TRACK 'SPIETHWAY III' [1790210]**



World class materials provide highest elasticity and reduce the arising strength peaks in the best possible way. Particularly suited as a tumble strip for training centers. Other lengths available upon request.

- Solid steel frame with fiberglass rods and plastic adapters for better pressure distribution, consisting of 21 elements of 4' (121 cm) x 6.5' (200 cm) each
- Covered with multi-layer, overlapping floor exercise mat "TRIFLEX®" with integrated grid material providing additional protection and durability of the mat
- Total length is 83' 4" (25.41 m)

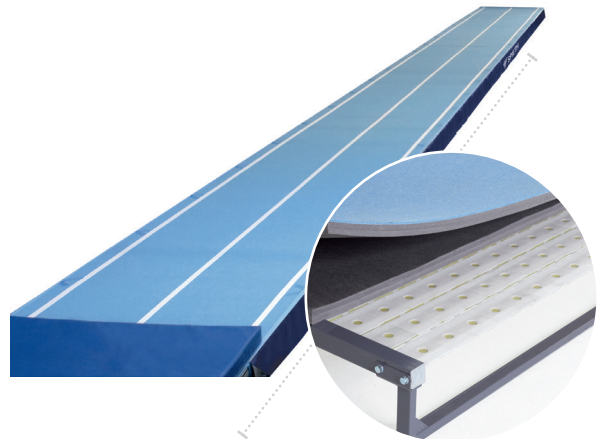



FIBERGLASS ROD FLOOR [MA-06040]

- 4'x6' section(s)
- Easy to assemble; easy to replace worn or damaged parts
- Tubular fiberglass rods ensure no "lock-up" when tumbling
- Each steel frame section is 8"(20 cm) high, 6' (1.8 m) wide and 4' (1.2 m) long
- Increased safety; less injury
- Recommended to pair with 1 3/8" Carpet Bonded Foam & 2" Foam (sold separately)



[MA-06040]

**RAS-RUNUP**

Rod Floor Run-Up

13' x 6' steel frame construction with plywood. 6 sections needed to create full Rod Floor Run-Up. Carpet Bonded Foam sold separately. (177-125).

**RAS100-RF**

Rod Floor Section

Carpet Bonded Foam and Foam Only. sold separately. See page 42-43.



[RAS-RUNUP]

TUMBL TRAK [VTL-21-10]

The Original Tumbl Trak is the "must have" training tool designed for increased repetition of tumbling and gymnastic skills by decreasing stress on limbs and joints. Used from beginner to elite levels, it allows athletes to learn and perfect new skills and progressions.



- Available in 20' - 60' lengths in 10' increments
- 10" wide pads with 18 oz knife coated vinyl and 1" thick EVA foam
- Bed is 60" wide black polypropylene bed with 6" tight coil

FRAME BAR BY TUMBL TRAK [VTL-TT-TB]

- Allows gymnasts to practice handstand skills, uprises and several release moves
- Easily attaches and detaches to the Tumbl Trak with steel knobs (no hardware required)





## Alberta Gymnastics Federation

T&T Provincial Championships

Product:  
T&T Landing Mats [shown below]  
Double Mini Trampoline [T23200]

## T&T LANDING MATS

- DM-LDG** Double Mini Landing System  
Includes four Landing Mats [TT-51012] and one Landing Zone [DM-LDGZONE]

---

- RF-LDG** Rod Floor Landing System  
Includes four Landing Mats [TT-51012] and one Landing Zone [RF-LDGZONE]

---

- TT-51012** Rod Floor or Double Mini Landing Mat  
5' x 10 x 12"

---

- FR-LDGZONE** Rod Floor Landing Zone  
6 1/2' x 13' yellow landing zone connects to the 10' x 20' landing mats at the end of the rod floor

---

- DM-LDGZONE** Double Mini Landing Zone

Red penalty zone and yellow landing zone area designed to be used at the end of a power tumbling rod floor. One end of the penalty zone Hook and Loops to the end of a rod floor and the other end hook and loops to the yellow zone

[RF-LDG]



REBOUND PRODUCTS 7' X 14' OVAL TUBE NON-FOLDING TRAMPOLINE

[DR-NONFLDTRAMP]

- Incorporates a three corner bracing system for ultimate support
- 90 degree corners
- Increased stability with an extra wide stance and no hinges
- Complete unit comes with Dave Ross 2 string bed, springs, pad lifter system, frame clips and padding



[DR-7X14]

REBOUND MODIFIED 7' X 14' ULTIMATE FOLDING TRAMPOLINE [DR-7X14]

- Created by Rebound Products and Eurotramp to produce the Grand Master Ultimate
- Includes Dave Ross string bed, springs, pad lifter system, frame clips, lifting roller and padding
- Modified frame for improved performance



[5006-110]

MINI-TRAMPOLINE

**5006-110** Mini-Trampoline

Frame size is 120 cm (47 1/4") x 120 cm (47 1/4")  
 Bed is 60 cm (23 5/8") x 60 cm (23 5/8")

**DR-MINI** Rebound Mini-Trampoline



[DR-MINI]

DOUBLE MINI-TRAMPOLINE [T23200]

All new Rebound DMT with 6 mm web bed or Dave Ross 2 string. Both include tapered, thick frame pads and, long life springs. This new frame is the same height, angle, and spring count as other competition frames but features stronger legs with bracing, chains replacing all shock cords to the legs. A more stable frame, with more durable legs at a lower price.





**Bison Ridge Rec Center**

Commerce City, Colorado

Product: Loose Foam Pit  
 Installation & Gym Design by US Gym Products

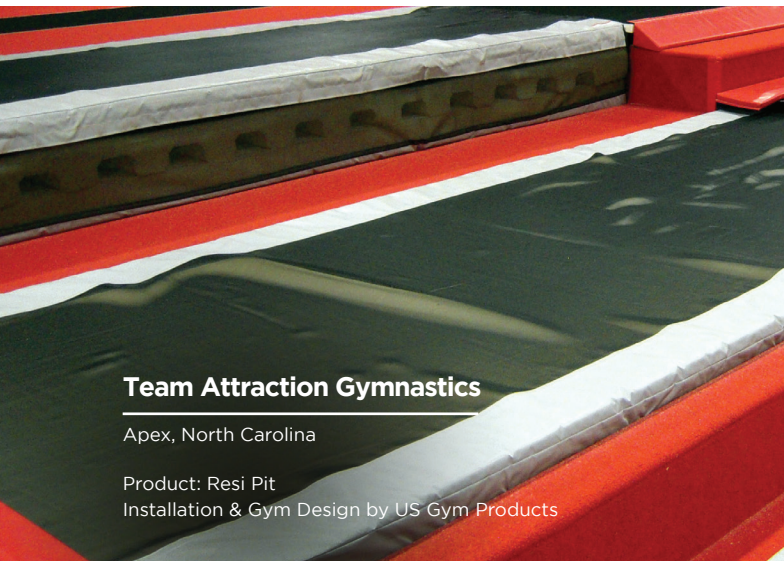
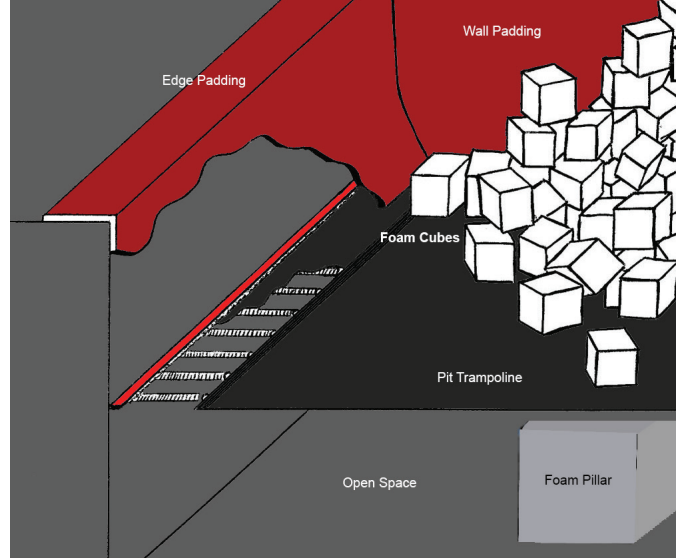

**Team Attraction Gymnastics**

Apex, North Carolina

Product: Resi Pit  
 Installation & Gym Design by US Gym Products

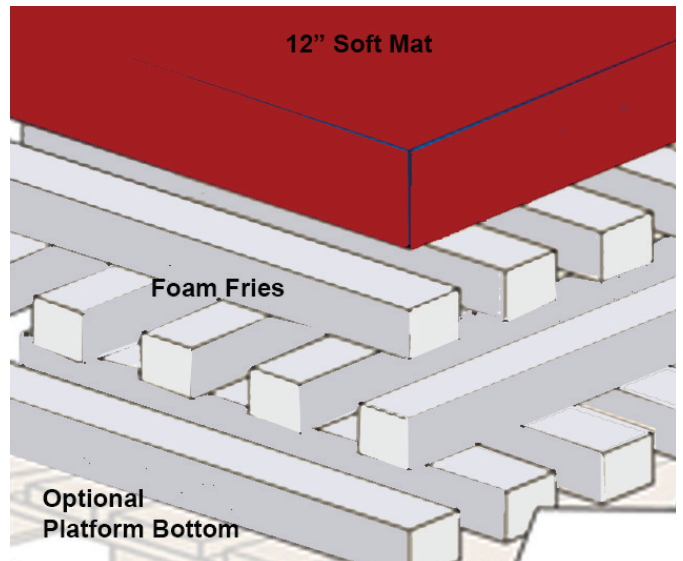

Waffle Foam Available [shown left]

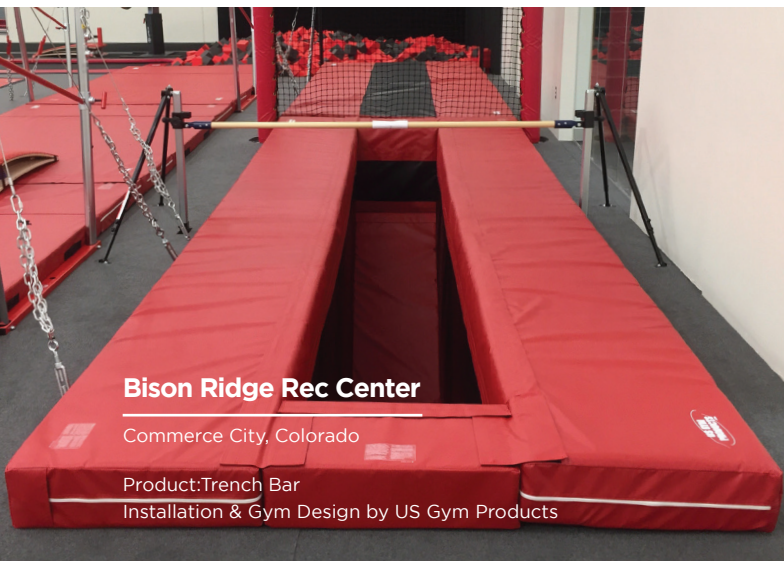

**Bison Ridge Rec Center**

Commerce City, Colorado

Product: Trench Bar  
 Installation & Gym Design by US Gym Products

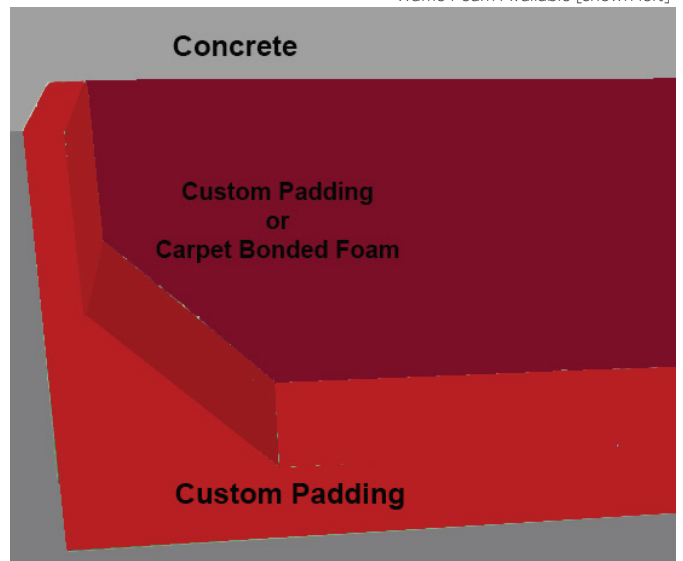

usgymproducts.com  
 877.Gym Products [877.496.7763]



**Kyle Shewfelt Gymnastics Center**

Calgary, Alberta

Product: In-Ground Trampoline & Loose Foam Pit

**LOOSE FOAM & IN-GROUND PITS**

Spieth America offers customized loose foam, in-ground resi pits.

The foam pit trampoline frame is constructed of angle iron with 1/4" round rod, zig-zag wire welded on for spring attachment and pre-drilled with holes for easy attachment to pit walls. Wedge bolts are also available for your convenience to use with trampoline pit frames when anchoring into concrete walls. The bed is made from polypropylene material. Spring attachments are spaced approximately 4 1/4" apart and set back from the edge leaving a flap to go over the top of the springs. The flap has holes approximately every two feet so it can be secured in place. Pit Edge padding is either carpet bonded foam or vinyl draping. Custom solutions are available.

The foam cubes come in two sizes - 6" or 8". The pit edge padding consists of the same material as our Carpet Bonded Foam (see page 43). Each panel is 6' long and 2" or 1 3/8" thick and secure to the wall with a contact adhesive. Sections come precut flat for easy use and installation.

**IN-GROUND TRAMPOLINES**

In-ground trampolines are level with the floor or pit and are available in 7' x 14' with a black poly bed or Dave Ross String Bed. Full pads and 120 springs are included.

**UAI-IGT-BPB** 7' x 14' with Black Poly Bed

**UAI-IGT-DRB** 7' x 14' with Dave Ross String Bed

**PIT EDGE PADDING**

**151** Pit Edge Padding  
6' x 3' x 1 3/8"

**151A** Pit Edge Padding  
6' x 3' x 2"

**FOAM PIT CUBES**

**151-06** 6" x 6' Foam Pit Cube

**151-08** 8" x 8' Foam Pit Cube

**SOFT TOP PIT MODULES**

**STPM51024** Soft Top Pit, 5' x 10' x 24"

**STPM61224** Soft Top Pit, 6' x 12' x 24"

**STANDARD PIT MODULES**

Each available 18", 24", and 32" high

| Standard |   |        |
|----------|---|--------|
| Width    | x | Length |
| 5'       | x | 10'    |
| 7.5'     | x | 12'    |
| 7.5'     | x | 16'    |
| 8'       | x | 16'    |





Spieth America, with input from Simone Biles, three-time World Champion & Four-Time Olympic Gold Medalist, has created the Simone Biles Signature product line so others inspired to grow their gymnastics skills can have access to the training tools Simone uses in her gym, the World Champions Centre.

Her signature line of products offer a great range of home and club training aids. You can order any of her signature line products at [trainlikesimone.com](http://trainlikesimone.com)

Simone  Biles BY 

The Simone for Home packages are a combination of several of the best selling products and perfect for at home training! They are designed for preschool to intermediate level gymnasts. Save money by purchasing one of these great packages below!



### BRIGHT STAR [SB-HPKG-BRS]

- Adjustable Bar, 3 - 5' H
- 8' Wood Adjustable Beam
- Folding Panel Mat, 4' x 8'
- Folding Mat, 3' x 6' x 4"



### GOLD STAR [SB-HPKG-GDS]

- Adjustable Bar, 3 - 5' H
- 8' Wood Floor Beam
- Folding Panel Mat, 4' x 8'



### SHINING STAR [SB-HPKG-SHS]

- Adjustable Bar, 3 - 5' H
- 8' Foam Learning Beam
- Folding Panel Mat, 4' x 8'



### STAR [SB-HPKG-STR]

- Adjustable Bar, 3 - 5' H
- Folding Panel Mat, 4' x 8'



### HOTSHOT [SB-HPKG-HTS]

- Floor Beam, 8' L x 6" H
- Folding Panel Mat, 4' x 6'



## TRAINING BAR

- Lightweight, portable and stable.
- Includes rail, and protective footpads (base extensions sold separately [SB-EXT]).
- Fits with the Junior Training Mat [SB-TM-484]
- Adjustable heights from 35" to 50" in 3" increments

**SB-BAR** Adjustable Training Bar

**SB-EXT** Adjustable Training Bar Base Extensions, Set of 4 (adds an additional 4ft. to bar base)

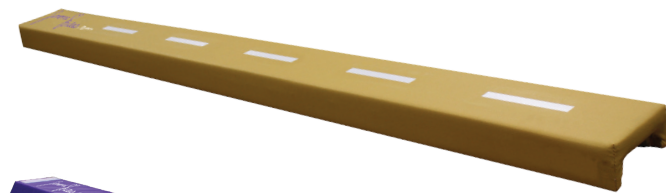

[SB-BSE]



[SB-FLB]

## BEAM ACCESSORIES

- Allows comfort and stability
- Smooth training tool for leaning beam skills

**SB-BSE** Beam Surface Expander  
8" W x 2.5m (8'3") L

**SB-FLB** Foam Learning Beam  
8' L x 10" W (bottom) 6" W (top) x 3 1/4" H.



## WOOD FLOOR BEAMS

- Designed for home gymnastics
- Built with laminated wood, topped with 3/8" foam, then wrapped in synthetic suede
- Braces are powder-coated steel to ensure durability, includes rubber end caps to prevent skidding

**SB-FB86** 4" x 8" x 6"

**SB-FB88** 4" x 8" x 8"

**SB-FBA** 4" x 8" x 12-18"



## PANEL MATS

- Designed for at home and club use
- Lightweight and easy to store
- Hook and loop on ends only

**SB-PM-46138** 4' x 6' x 1 3/8", Light Purple/Purple

**SB-PM-48138** 4' x 8' x 1 3/8", Light Purple/Purple



[SB-PM-48138]

## MULTI-PURPOSE MAT

- Designed for at home and club use
- Adapts particularly well to beam and bar usage

**SB-MPM** 38" W x 55" L x 3/4" H



[SB-FIN]



[SB-TM-364]

## FOLDING MATS

- Designed for at home and club use
- Folding Mat will fit underneath the Adjustable Balance beam and the Adjustable Bars

**SB-TM-364** Folding Mat: 3' x 6' x 4"

**SB-FIN** Folding Incline  
24" W x 48" L x 14" H; Folds to 24" x 24" x 14"



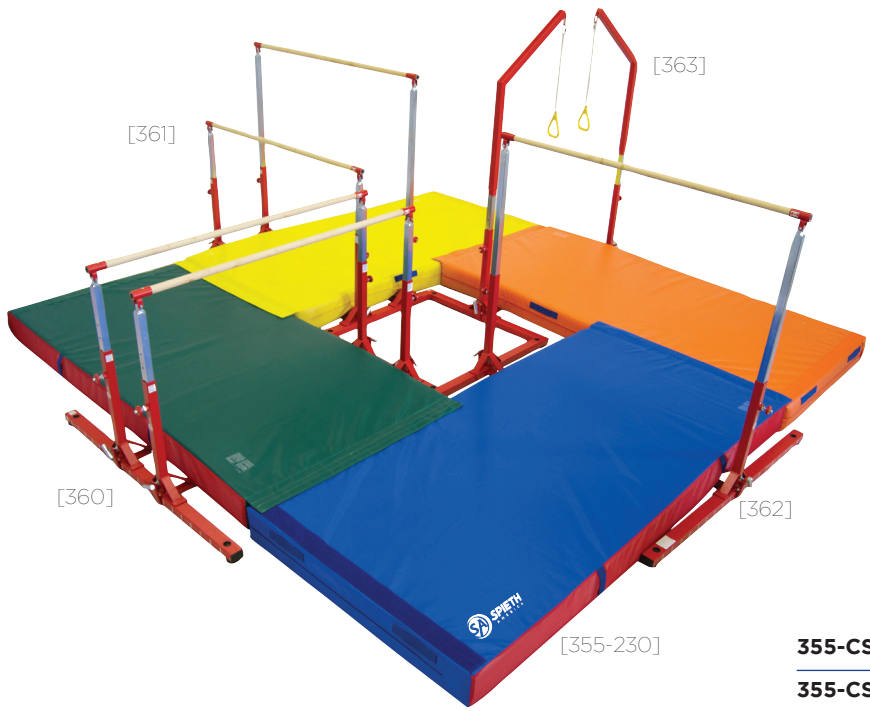

### 4-STATION CIRCUIT

- A modular design which allows equipment to be used individually or as a circuit
- A wide range of preschool accessories
- The new ergonomic spin-snap lock design, provides a fast and secure height adjustment
- Multi-configuration

**355-CS** Complete Circuit with 8" mats (Shown)

**355-CS4** Complete Circuit with 4" mats



[355-430]

### SKILL CUSHIONS MATS

**355-230** Each Mat 5' x 10' x 8" (Set of 4)

**355-430** Each Mat 5' x 10' x 4" (Set of 4)



[355-230]

|            |        |
|------------|--------|
| RED        | ORANGE |
| DARK BLUE  | BLUE   |
| PINK       | WHITE  |
| YELLOW     | GREEN  |
| LIGHT BLUE | PURPLE |
| GRAY       | BLACK  |



Hook and Loop attachments to connect mats



[360]



[361]



[364]



[366]

## INDIVIDUAL APPARATUS

- Provide skill-building opportunities for beginner gymnasts from preschool to school age
- Rails made of wood veneered fiberglass
- Low bar adjust from 36" to 53" in 3" increments
- Width of double units adjust from 12 1/2" to 57 1/2"
- Ring frame adjusts from 45" to 57 1/2"
- Mats sold separately



[363]

Trapeze Accessory  
[355-330]

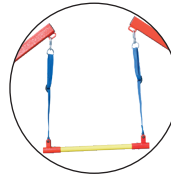

[362]

Steel Rail Accessory  
[355-69]



## JUST FOR KIDS CANTILEVER BARS

[365A]

- Low bar height adjusts from 32" to 91 1/2" in 3" increments
- Low bar also adjusts horizontally from 11 1/2" to 17 1/2"
- Requires only 6' x 10' floor space
- High bar height adjusts from 44" to 100 1/2" in 3" increments



Low bar adjusts horizontally  
from 11 1/2" to 17 1/2"



Low bar adjusts from  
32" to 91 1/2"



## BASE PADDING

[355-BP2]

Sold as a set:

- 4 pads @ 31.5" L x 12" W x 4.5" H once folded
- 2 pads @ 14" L X 12" W X 4.5" H once folded

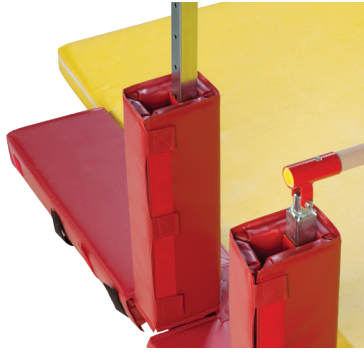

## UPRIGHT PADDING

[355-UP]

Just for Kids Upright Padding provides cushioned protection around the metal uprights. JFK Upright Padding should be used along with our Base Padding (355-BP2). Sold in pairs.



## CENTER BASE PADDING

[355-CSP]

Just for Kids Circuit Padding creates a safe place for kids to land during circuit practice.



[118-LBP]



[165-LBP]



[355-LBP]

## LEG BASE PADDING

The Leg Base Padding is an economical option to protect the bases of the Low Beams (118 and 355-151/165), Steel Parallel Bar Trainers, and Just for Kids apparatus. Hook and Loop straps secure the pad around the base. Padding is sold in pairs.

**118-LBP** Low Beams  
13" W x 27" L x 3/4" H

**165-LBP** Parallel Bars  
13" W x 33" L x 3/4" H

**355-LBP** Just For Kids Leg Base Padding.  
13" W x 60" L x 3/4" H



## WIDE TRAINING BEAM [355-151/165]

This beam's extra-wide surface is perfect for teaching beginner skills and building confidence. 8" W x 86" L x 11" H



## LITTLE THUMPER BOARD [338]

A smaller board designed for multiple skill development and to be used by younger gymnasts. Recommended weight limit is 50 lbs.

**SINGLE BAR ACCESSORIES**

|                 |                                |
|-----------------|--------------------------------|
| <b>355-170B</b> | Adjustable Monkey Bar Assembly |
| <b>355-300</b>  | Slide                          |
| <b>355-200</b>  | Cargo Net                      |
| <b>355-401</b>  | Rockwall (2.5' x 5')           |
| <b>355-402</b>  | Rockwall (4' x 5')             |
| <b>355-403</b>  | Rockwall (4' x 8')             |
| <b>355-69</b>   | High Bar Steel Rail            |



**RING FRAME ACCESSORIES**

[363]

|                |                    |
|----------------|--------------------|
| <b>355-225</b> | Ring Frame Climber |
| <b>355-330</b> | Trapeze            |



**MIX 'N MATCH ACCESSORIES**

Climbing Island, Just for Kids & Shinobi Training customized unlimited possibilities of fun!



Climbing Island products on pages 74-75  
 Shinobi Training products on pages 76-81

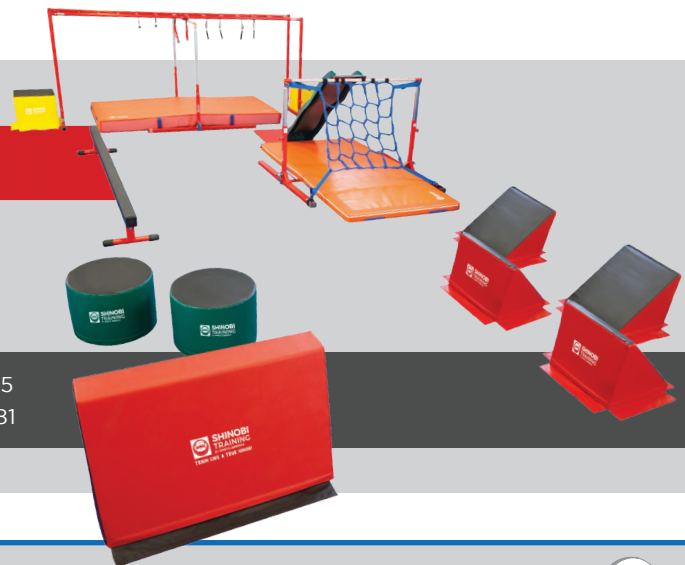



**MONKEY BARREL**  
[CMB-1]

Excellent tool to develop balance and coordination

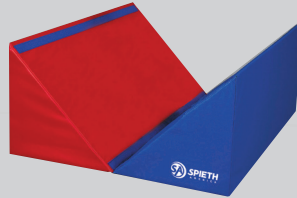

**BIG VALLEY**  
[CBV-1]

24" W x 60" L x 24" H



**FUN CUBE**  
[CFC-1]

- Red/Yellow/Orange/Green
- 2' W x 8' L when flat
- 2 sq. ft. folded into a cube



**CRADLES & DRUMS**

|              |                                   |
|--------------|-----------------------------------|
| <b>CDR-1</b> | 12" D x 30" L Drum, Red           |
| <b>CDR-2</b> | 18" D x 30" L Drum, Yellow        |
| <b>CDR-3</b> | 24" D x 30" L Drum, Blue          |
| <b>CCR-1</b> | Pair of Cradles, 1 Red and 1 Blue |

**ROCK 'N' ROLL [CRR-1]**

**Includes:**

- System includes two 12" x 30" rolls, two 18" x 30" rolls and one 24" x 30" roll
- Logs are securely held together by a strap system
- Blue/Yellow/Red



Shown with Rainbow Mat (48IVEOR), sold separately



FOAM STEPS

[CCS-1]

21" W x 33" L x 24" H

MAILBOX

[CMBX-1]

16" W x 36" L x 20" H

FUN DOME

[CFM-1]

Green, Red, Yellow and Orange. 18" H x 55" D

**DONUT HALVES & STUFFERS**

- CHRD-1** 15" x 48" Diameter, 15" x 26" D  
Green/Yellow/Red/Orange

---

- CHRD-2** 18" x 52" Diameter, 18" x 30" D  
Blue/Light Blue/Red

---

- CHRD-3** 30" x 52" Diameter, 30" x 30" D  
Blue/Red/Yellow/Green/Orange

---

- CHRD-4** 30" x 59" Diameter, 30" x 36" D  
Blue/Yellow/Red

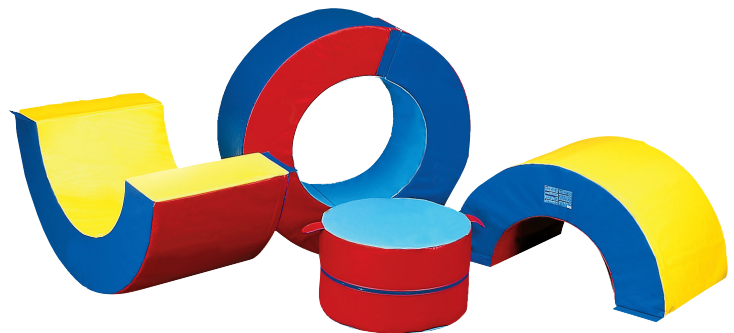

**ROLLER TUNNEL [CRT-1]**

**Includes:**

- Roller is 30" L x 22" D
- Stuffer is 30" L x 13" D





## DISCOVERY PLAYLAND [CDP-1]

A combination of some of our most playful and exciting developmental training tools. This obstacle or circuit course provides a wealth of challenges! The perfect setting to promote agility and strength, balance and coordination.

Includes:

- 1 Big Valley (CBV-1)
- 1 Foam Steps (CCS-1)
- 1 Monkey Barrel (CMB-1)
- 1 Little Thumper (338)
- 1 Junior Zoid (CVB-2)
- 1 Mailbox (CMBX-1)
- 1 Foam Dome (CFM-1)
- 1 Mini Mountain Climber (CMC-5)
- 1 Fun Cube (CFC-1)
- 1 Donut Stuffer and Half (CHRD-2)
- 1 8" x 52" Diameter, 18" x 30" Diameter
- 1 Incline (CHIM-1) 24" W x 48" L x 14" H
- 1 Rainbow Mat (481VEOR)
- 1 Panel Mat 6' x 12' x 1 1/4"



## TIDBIT PLAYLAND [CTB-7]

The Tidbit Playland offers a variety of circuit set-ups to teach balance, coordination and fundamental skills from preschool to recreational classes. The blocks can be stacked to create stairs and assist smaller gymnasts onto apparatus or used as spotting blocks.

**Includes:**

|               |                  |                         |
|---------------|------------------|-------------------------|
| <b>CTB-TT</b> | Teeter Totter    | (24" W x 70" L x 12" H) |
| <b>CTB-LG</b> | Large Blocks     | (24" W x 70" L x 12" H) |
| <b>CTB-SM</b> | Small Blocks     | (24" W x 35" L x 12" H) |
| <b>CTB-FI</b> | Folding Inclines | (24" W x 70" L x 12" H) |

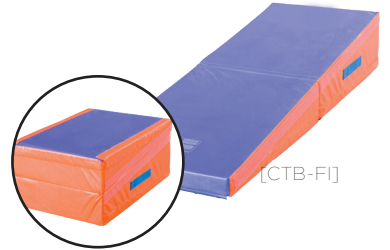

## MINI MOUNTAIN CLIMBER [CMC-5]

**Includes:**

- 1 4' x 4' Stacking Mat Mountain
- 1 Block (24" x 30")
- 1 Incline (24" x 36")



## MOUNTAIN CLIMBER [CMC-8]

**Includes:**

- 1 5' x 5' Stacking Mat Mountain
- 1 Block (24" x 24")
- 1 Incline (30" x 60")



## GIANT MOUNTAIN CLIMBER [CMC-13]

**Includes:**

- 1 The Mountain Climber
- 1 Roller Tunnel
- 1 Rock 'n' Roll
- 1 Pair of Cradles
- 2 Safety Mats (36" x 84" & 30" x 48")
- 1 Rainbow Mat (4' x 8' x 11/4")



## CLIMBING ISLAND: ADAPTIVE INNOVATION

[1555534]



- Turns any space into a play area in 3 minutes
- Ready to go, complete with 2 collapsible mats
- Easy to move, store and requires no anchors
- System comes fully assembled
- Combine the Climbing Island with many of the available accessories for unlimited possibilities
- Assembled dimensions are 85" (216 cm) L x 38" (96 cm) W x 89" (227 cm) H

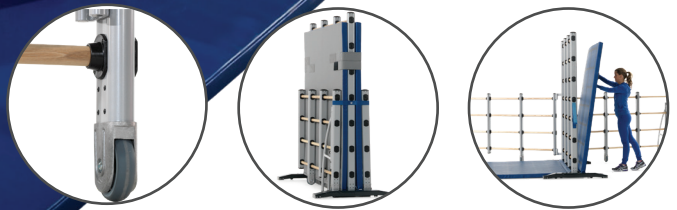

### WALL BAR & ACCESSORIES

- MS-21212** Stall Bar 34"x96" Hard wood 1/2"
- MS-21213** Junior Stall Bar 24" x 84"
- 5106-FM** Half Bend Foam Module for Wall Bar

WOODEN LADDER

- 1495164** Wide Ladder (shown)  
[12" (31 cm) 27" (68 cm) W x 9'10" (300 cm) L]

---

- 1495175** Narrow Ladder  
[9 1/4" (23.5 cm) 17 5/16" (44 cm) W x 9'10" (300 cm) L]



ZIGZAG LADDER [1495264]

16 Rungs  
14 3/16" (36 cm) W x 9'10" (300 cm) L



CHICKEN LADDER [1495270]

10 Wooden Steps  
9 7/16" (24 cm) W x 9'10" (300 cm) L



WOOD BALANCE BEAM [1490364]

One rounded and one flat side.  
Each side has an different degree of difficulty.  
2 3/4" (7 cm) W x 3 15/16" (10 cm) H x 9'6" (290 cm) L



FLEXIBLE PLANK [1495320]

Very springy with hook-in bracket and clamps  
9 7/16" (24 cm) W x 9'10" (300 cm) L



BENCH PLANK [1490930]

Self-clamping in middle and at ends  
Can be used as a bench or seesaw  
9 7/16" (24 cm) W x 9'10" (300 cm) L



WOODEN SLIDE [1495254]

Slide has raised sides for safety  
13" W Chute x 8'2" (250 cm) L



MIX 'N MATCH ACCESSORIES

Climbing Island, Just for Kids & Shinobi Training  
customized unlimited possibilities of fun!

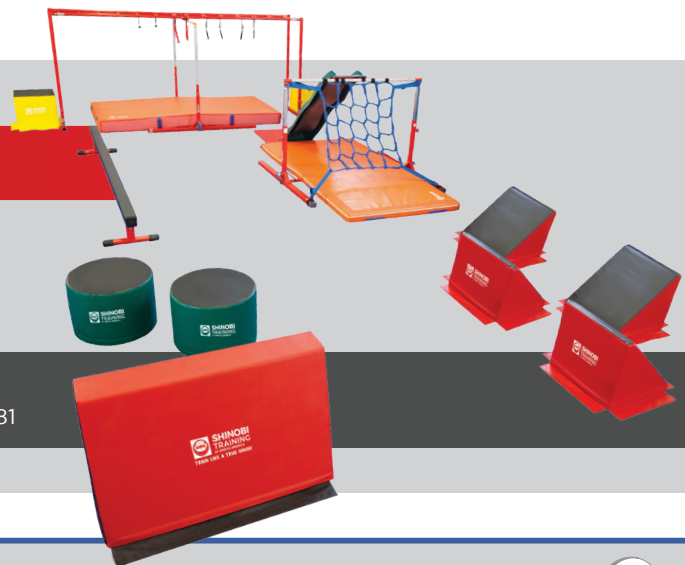

Just for Kids products on pages 66-73  
Shinobi Training products on pages 76-81



## MIX 'N MATCH ACCESSORIES

Create your own customized ninja course specific to what you need for your little ninjas.

Start with a prebuilt Shinobi Package (*shown right*), add in the Climbing Island & Just For Kids Accessories, or start from scratch.

Mix 'N Match Climbing Island, Just for Kids & Shinobi Training for customized unlimited possibilities of fun!

Just for Kids products on pages 66-73  
Climbing Island products on pages 74-75

## KYU BEGINNER PACKAGE [ST-KYU]

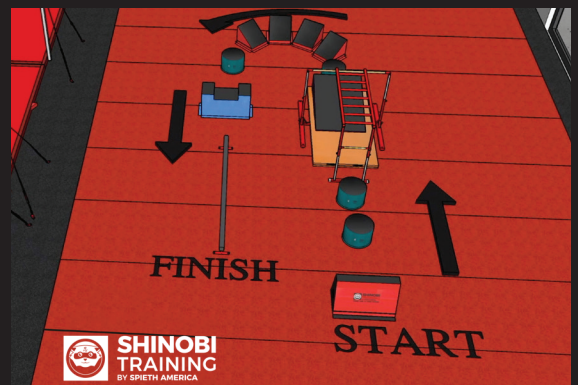



# SHINOBI TRAINING

BY SPIETH AMERICA

## TRAIN LIKE A TRUE NINJA!

Featuring many new and innovative accessories such as the Wobble Beam, Multi-Functional Monkey Bars with the Salmon Ladder and Ninja holds to provide you the most unique and effective ninja training.



[ST-STP4]

[ST-BLK]

[ST-BEAM]

[ST-PLR2]

[ST-BNCH]

## SHIDOSHI PACKAGE [ST-SHIDOSHI]

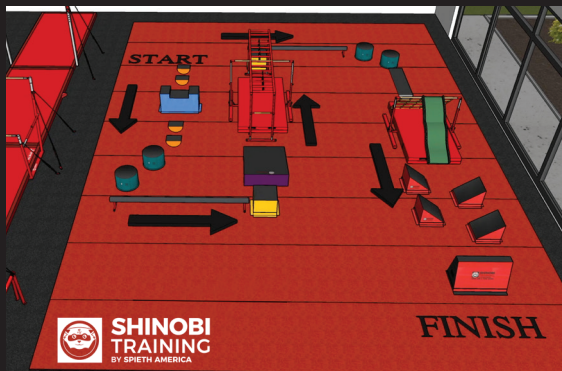

[Shown Above]

## SHIHAN PACKAGE [ST-SHIHAN]





## OBSTACLE COURSE 10 PIECES

[ST-OBS10]

Includes:

- 1 Bench [ST-BNCH]
- 4 Pillars [ST-PLR4]
- 1 Barrier [ST-BRR]
- 4 Slanted Steps [ST-STP4]



## SLANTED STEPS

24" W x 24" L x 21" H

Standard Color: Red/Black

**ST-STP** Slanted Step

**ST-STP2** Slanted Steps, set of 2

**ST-STP4** Slanted Steps, set of 4



## BENCHES

20" W x 48" L x 26" H

Standard Color: Blue/Black

**ST-BNCH** Single Bench

**ST-BNCH2** Bench, set of 2

**ST-BNCH4** Bench, set of 4



## OBSTACLE COURSE 17 PIECES

[ST-OBS17]

Includes:

- 1 Set of Stepping Stones [ST-ROCKS4]
- 4 Pillars [ST-PLR4]
- 1 Balancing Log [ST-LOG]
- 1 Bench [ST-BNCH]
- 2 Blocks [ST-BLK2]
- 1 Barrier [ST-BRR]
- 4 Slanted Steps [ST-STP4]





**BLOCKS**

24" W x 24" L x 20" H  
Standard Color: Yellow/Black

- ST-BLK** Block

---

- ST-BLK2** Blocks, set of 2

---

- ST-BLK4** Blocks, set of 4



**PILLARS**

17" H x 24" Diameter  
Standard Color: Green/Black

- ST-PLR** Pillar

---

- ST-PLR2** Pillars, set of 2

---

- ST-PLR4** Pillars, set of 4



**STEPPING STONES**

12" W x 18" L x 8" H, each  
Standard Color: Orange/Black

- ST-ROCKS** Rocks, set of 2

---

- ST-ROCKS4** Rocks, set of 4



**INCLINE**

36" W x 72" L x 16" H  
Standard Color: Purple/Black

- ST-INCL** Single Incline

---

- ST-INCL2** Incline, set of 2



**SINGLE BARRIER**

24" W at the bottom;  
Standard Color: Red/Black

- ST-BRR** Single Barrier

---

- ST-BRR4** Barrier, set of 4

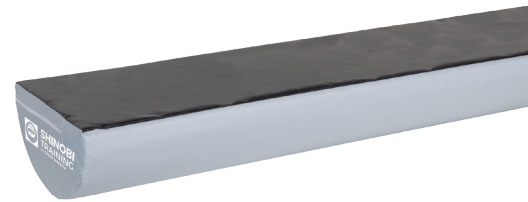

**LOG**

18" W x 72" L x 8" H  
Standard Color: Grey/Black

- ST-LOG** Single Log

---

- ST-LOG2** Logs, set of 2



**WOBBLE BEAM**

[ST-BEAM]

- Features springs to create wobble while walking across it
- Spring tension is adjustable to increase or decrease wobble and difficulty depending on weight and age of the ninja
- 12' L x 4" W x 13" H

# MIX 'N MATCH ACCESSORIES



## NINJA HOLDS

All the Shinobi Ninja hold straps are made of 1" nylon webbing that loops around any rail for portability and ease of use. They can be added to a Shinobi Training course or used as part of your conditioning program.



## HANGING CLIMBING CARGO NET [ST-HCARGO]

- Designed and fabricated to mimic a very popular ninja obstacle
- Recommended for indoor use only, either over a foam pit or with at least an 8" soft landing mat
- Mounting hardware and foam cubes sold separately



## ROPES [ST-NHR] Set of 4



## NUNCHUCKS [ST-NHN] Set of 4

- 8" L x 1 1/2" diameter with anti-slip rubber coating



## BALLS [ST-NHB] Set of 4

- 1 7/8" diameter balls



## CLIMBING ROPE [H37600]

- Includes Steel Eye Bracket and Anti-Fray Sleeve
- 6 m (19.7 ft)

## JUST FOR KIDS SLIDE & CARGO NET

[355-300]  
[355-225]

- Shown with the 355-430S Skill Cushion and the 362 High Bar



[355-225]

## CLIMBING WALL HOLDS

[ST-CHOLDS]

- Set includes 20 holds of random sizes and shapes in green, yellow, blue and red
- Hardware not included



MONKEY BAR [355-170B]

- Can be used on the Polaris Quad Bar (Shown here), the Just For Kids High Bar (362), or any uneven low bar
- Includes brackets to link two units together (Second unit sold separately)
- Height adjusts from 64 1/2" to 81" in 3" increments
- Overall size is 6' L x 28" W

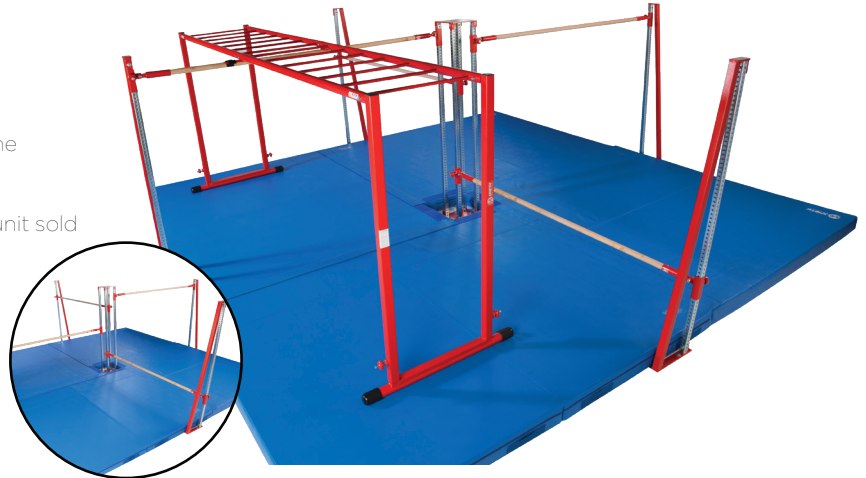

[4000] Page20

SALMON LADDER [ST-LADDER]

[ST-LADDER]

- Builds upper body strength and coordination by mimicking a common adult ninja course obstacle
- The movable rung is pulled up as the ninja ascends
- Designed not to come off or fall down when the little ninjas are working their way up
- Mounts on the Monkey Bar (355-170B - sold separately)



CLIMBING FRAME CARGO NET [ST-FCARGO]

[ST-FCARGO]

- Tension of the net can be adjusted
- Frame folds up for easy storage
- Hanging Cargo Nets Available

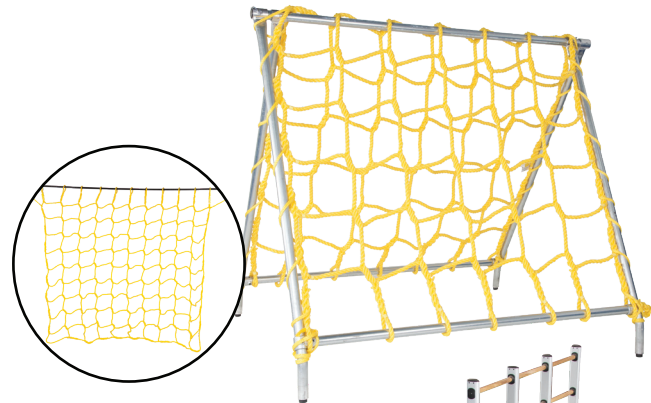

**ST-1010CARGO** Cargo Net - 10' x 10'

**ST-1212CARGO** Cargo Net - 12' x 12'

MIX 'N MATCH ACCESSORIES

Climbing Island, Just for Kids & Shinobi Training customized unlimited possibilities of fun!

Just for Kids products on pages 66-71  
Climbing Island products on pages 72-73

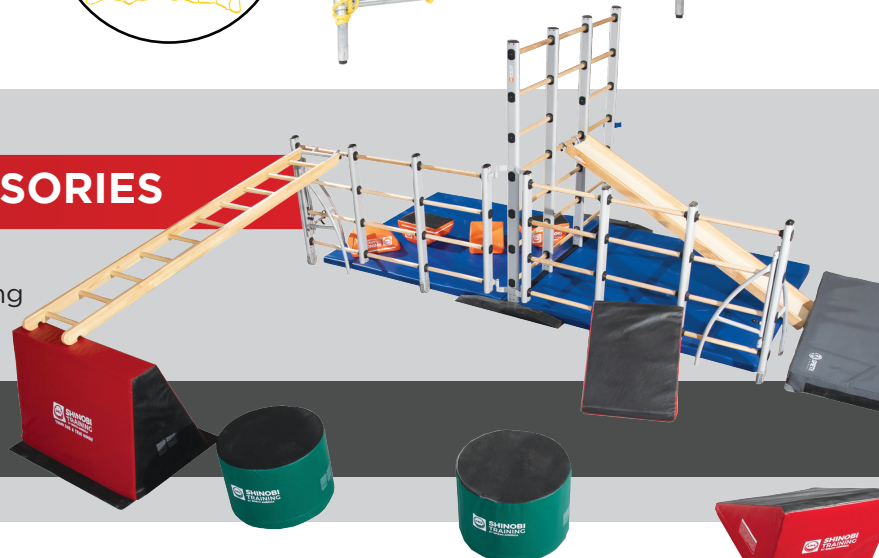

PARKOUR EQUIPMENT

**SA PARKOUR**

**Each Module features:**

- The Parkour System is a modular series of plyometric boxes, rails and accessories adaptable to any space
- Can be used on any side and in an endless array of configurations
- Designed to utilize a range of sizes from small to large allowing you to build your own course
- Incorporates a series of interlocking internal devices that support even the most extreme uses
- Built with high-quality, American made, cabinet-grade plywood cut on a precision CNC machine giving it a reliable quality standard



**PARKOUR PACKAGE [PK-1000]**

Includes:

- 2 A1 Training Box 16" X 24" X 32" [Pk-20001/1]
- 1 A2 Training Box 32" X 32" X 24" [Pk-20002/1]
- 1 A3 Training Box 32" X 32" X 48" [Pk-20003/1]
- 1 A4 Training Box 32" X 48" X 64" [Pk-20004/1]
- 1 T1 Triangle Training Box 24" X 32" X 40" [Pk-20001/1]
- 1 T2 Triangle Training Box 32" X 48" X 58" [Pk-20012/1]
- 28 Connecting Clips
- 2 48" Pipes
- 2 16" Pipes
- 1 Elbow & Pipe Fittings



A1 TRAINING BOX  
[PK-20001/I]

- 16" x 24" x 32"



A2 TRAINING BOX  
[PK-20002/I]

- 32" x 32" x 24"



A3 TRAINING BOX  
[PK-20003/I]

- 32" x 32" x 48"



A4 TRAINING BOX  
[PK-20004/I]

- 32" x 48" x 64"



T1 TRIANGLE  
TRAINING BOX  
[PK-200011/I]

- 24" x 32" x 40"



T2 TRIANGLE  
TRAINING BOX  
[PK-200012/I]

- 32" x 48" x 58"

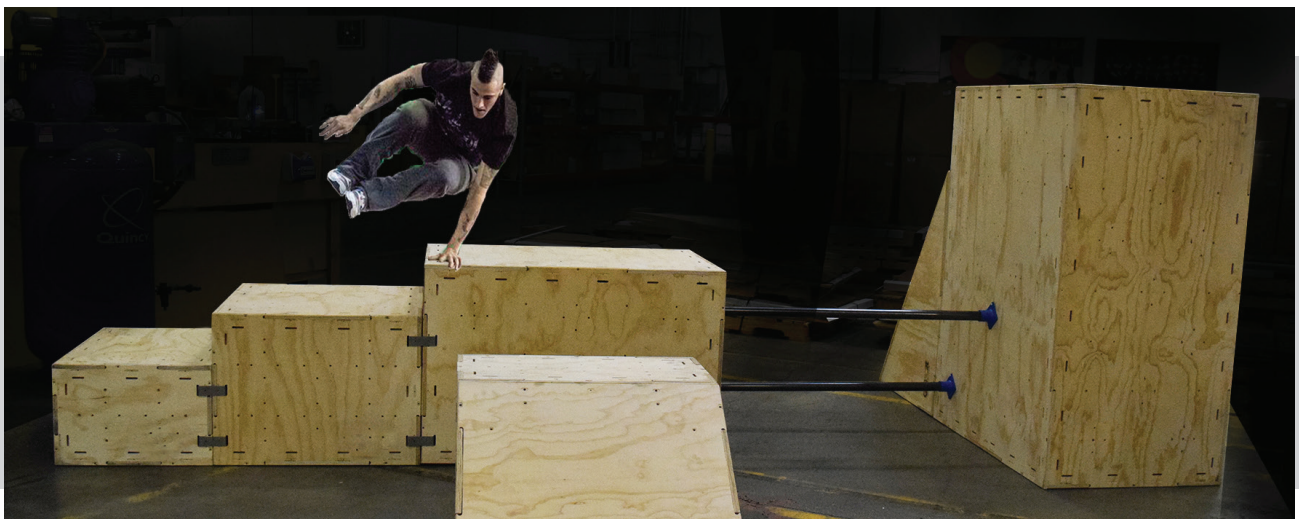

## SA PARKOUR COURSE

Parkour and Free running are rapidly growing in popularity. Now a FIG recognized sport involves overcoming urban and environmental obstacles.

Spieth America has created the Parkour Training Line, a specific range that focuses on recreating obstacles for the non-competitive disciplines with emphasis on creativity and self expression. Each module has been carefully designed in collaboration with several organizations to ensure the fundamentals of the discipline.

### Each Module features:

- High quality foam filler, reinforced with polyethylene foam for optimal stability
- Heavy duty vinyl and carrying handles
- Anti-skid bottom
- Hook & loop fasteners to secure modules together



[PK-900]

[PK-926]



[PK-930]



[PK-910]

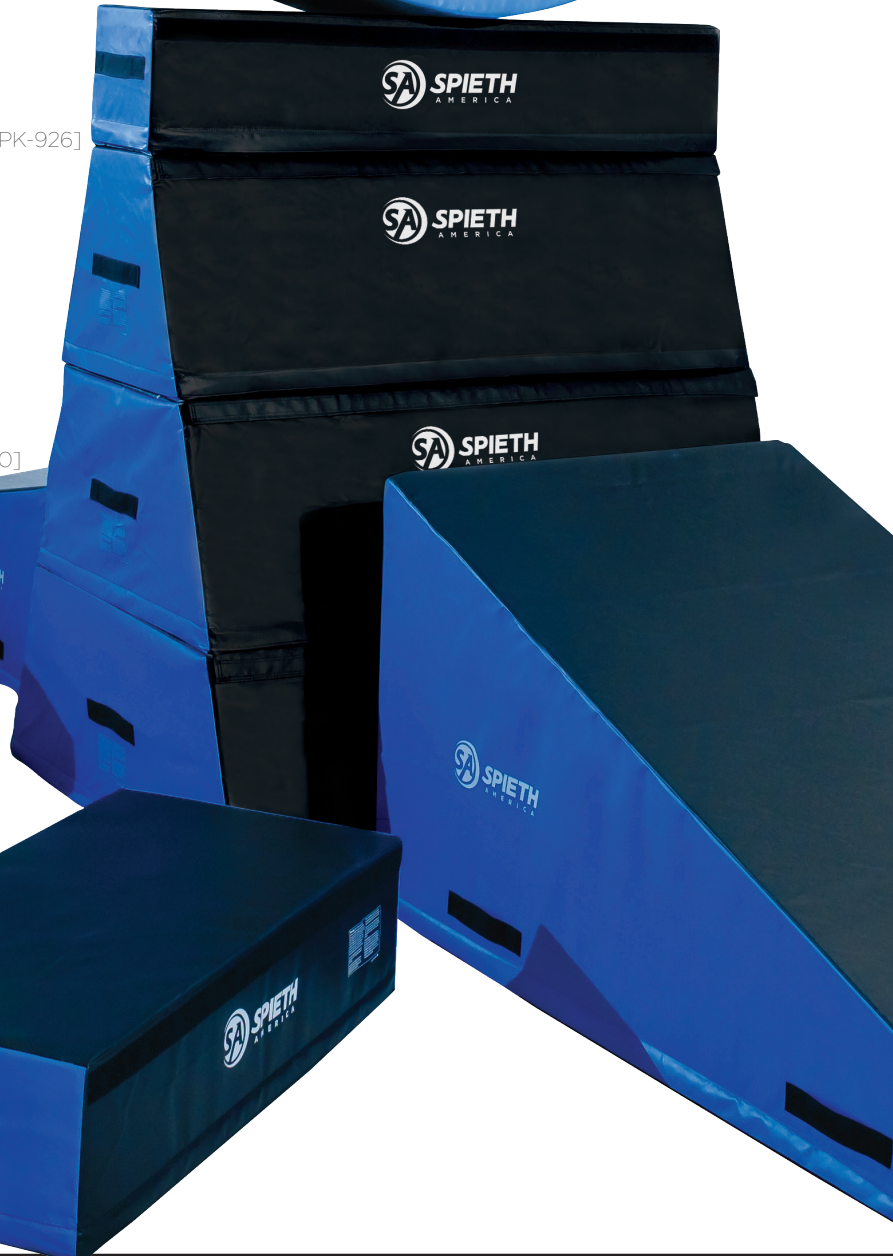

## TRICK TRAPEZE

|               |                                      |
|---------------|--------------------------------------|
| <b>PK-926</b> | Trick Trapeze Bundle                 |
| <b>PK-920</b> | Trapeze Bundle (Bottom three pieces) |
| <b>PK-925</b> | Trick Step 60" x 12" x 12"           |
| <b>PK-921</b> | Small Trapeze 60" x 25"- 12" x 20"   |
| <b>PK-922</b> | Medium Trapeze 60" x 38"-25" x 20"   |
| <b>PK-923</b> | Large Trapeze 60" x 51"-38" x 20"    |



## BLOCKS

|               |                              |
|---------------|------------------------------|
| <b>PK-930</b> | Blocks Bundle                |
| <b>PK-931</b> | Small Block 48" x 24" x 12"  |
| <b>PK-932</b> | Medium Block 48" x 24" x 16" |
| <b>PK-933</b> | Large Block 48" x 24" x 24"  |



## INCLINES

|               |                                    |
|---------------|------------------------------------|
| <b>PK-910</b> | Inclines Bundle                    |
| <b>PK-911</b> | Small Incline 78" x 42" x 24" - 6" |
| <b>PK-912</b> | Large Incline 78" x 42" x 36" - 6" |

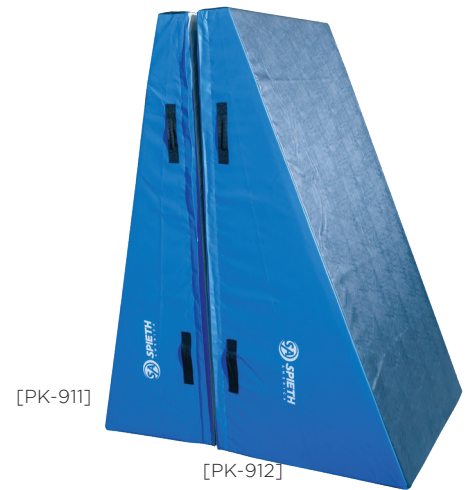

## TRICK HOOP

|               |                                      |
|---------------|--------------------------------------|
| <b>PK-900</b> | Trick Hoop 63" O.D. x 40" I.D. x 20" |
|---------------|--------------------------------------|

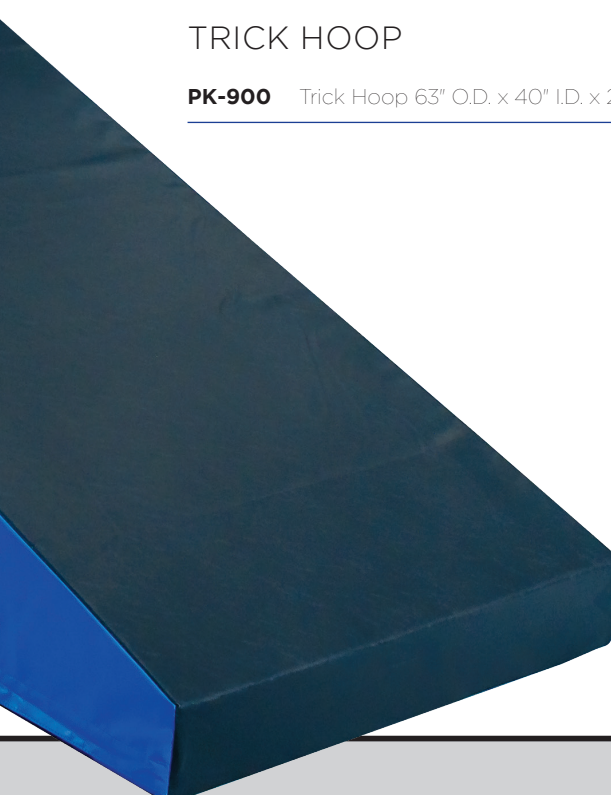
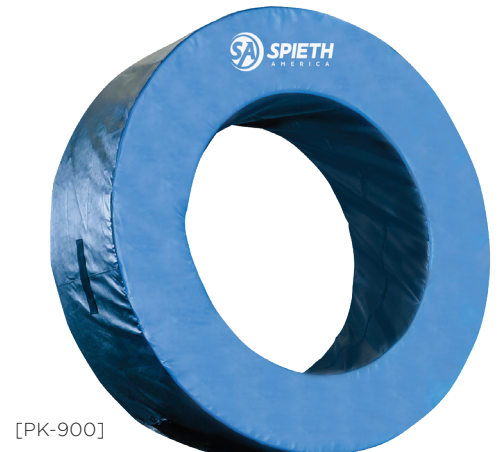



Sparda-Bank **SPIETH**

**Simone Biles | Pokal World Cup**

Stuttgart, Germany



**Ellie Black | Canadian National Championship**

Ottawa, Ontario

At Spieth America we take pride in having the most innovative equipment worldwide! We are the most trusted, recognized and reliable equipment company in the world. Aboe partner companies supply the majority of all World Class Events. It is now our goal to provide the same World Class Equipment used at the Olympic Games to North America. In doing so, we are helping you build first class Invitational and Regional events nationwide!

Experience our innovative meet rental for yourself to understand why Spieth America is the preferred equipment supplier to Gymnastics Canada and NAIGC. Gymnastics figures such as Simone Biles, Ellie Black, Sam Mikulak, Kim Zmeskal, Gustavo Moure, Laurent Landi, Liang Chow and many more have proudly chosen Spieth America.

Where Innovation Meets Gymnastics.



**NAIGC National Championship**

Daytona Beach, Florida

## ERGOJET VAULTING TABLE

Best vault table in the world and used at the RIO Olympics. It has a built-in transport system to make it easy to move in your venue. Smooth height adjustments with the unique gas spring system. It was used in World Championships. F.I.G. Approved.



## MOSCOW FLOOR

The floor has a new spring system for optimum rebound and uses a high quality foam layer for a faster response. In between the carpet layer and sprung deck there is a puzzle piece foam system for optimal shock absorption to prevent injuries and increase the safety for all athletes. F.I.G. Approved.



## ALL-AMERICAN UNEVEN BARS

Uses the same height and width markings you are used to with other bars in the US so adjustments and transitioning to SPIETH America bars is effortless. We have also incorporated Gas Shock technology in our uprights so coaches no longer need to stand on spotting blocks to adjust the bar height setting!



## SPIETH AMERICA CRANK BEAM

A SPIETH America exclusive, is the only one of its kind in the world. The entire beam adjusts with a simple crank handle making quick meet adjustments between athletes a smooth transition.



## GYM DESIGN SERVICES

Whether you are looking to open a new gym, expand your current one or redesign your existing space, we can help design the layout to maximize your space. The step-by-step method gives us the ability to help you select the right equipment for your facility, design an efficient equipment setup, and purchase the products you need within your budget.

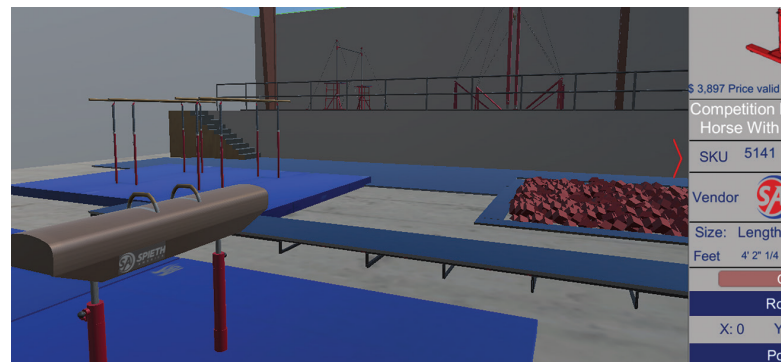



## TOP CLASS MEET TECHS

Our professionally trained technicians are here to help you with their combined 30 years of experience. They assist our customers with set up and are onsite to assist with equipment during the meet to assure 100% customer satisfaction.



## SIMPLIFIED SET UP

Trailers fully equipped with ramps for easy and safe equipment unloading and loading at each event.



## TIME SAVING CASES

We are making your meet set up and tear down much more efficient with our time saver cases. Our cases protect your equipment, but help to improve the installation and dismantle process. Saving you and the facility time.



## INNOVATIVE WEIGHT KITS

Innovative weight boxes that roll on a pallet jack for uneven bars, high bar, and ring tower. These portable kits eliminate the hassle of filling up and transporting water jugs.



## MEET TRAILERS NATIONALLY

Spieth America produces over 200 meets in North America, utilizing a fleet including more than 20 corporate event trailers staged nationally through the US and Canada.





Texas Tough Invitational

Arlington, Texas

We at Spieth America have modified all of our equipment so athletes and coaches have a smooth transition when experiencing Spieth America for the first time.

The feedback we have received after producing events in North America is astonishing. Athletes and coaches are all enjoying an innovative change in the equipment supplier. Athletes have reported experiencing a quick recovery shortly after competing due to our Moscow Floors. The high-quality puzzle piece foam configuration between the carpet bonded foam and spring deck provides athletes optimal shock absorption to prevent injuries and increase the safety of all athletes.



Excalibur Cup

Virginia Beach, Virginia



Excalibur Cup

Virginia Beach, Virginia

**INTERNATIONAL COMPETITION PODIUM**



**Stuttgart World Cup**

Stuttgart, Germany  
Produced by SPIETH Gymnastics

**COMPETITION PODIUM "RIO"**

This competition podium has been featured at numerous international championships and is recognized by the International Gymnastics Federation.



Bringing world class meet presentation to North America. These podiums are now available for sale and available upon request for meet rentals.

**Equipment Features**

- Modern appearance, with a solid build
- Constructed of modular single steel frames each 6' 6" (200cm) x 3' (100cm)
- Comes equipped with stairs and anchor points for counterweights
- Dimensions are individually adaptable according to customized competition needs
- Suited for TV broadcasts and ideal for athlete presentation
- Suitable for sports and activities beyond gymnastics



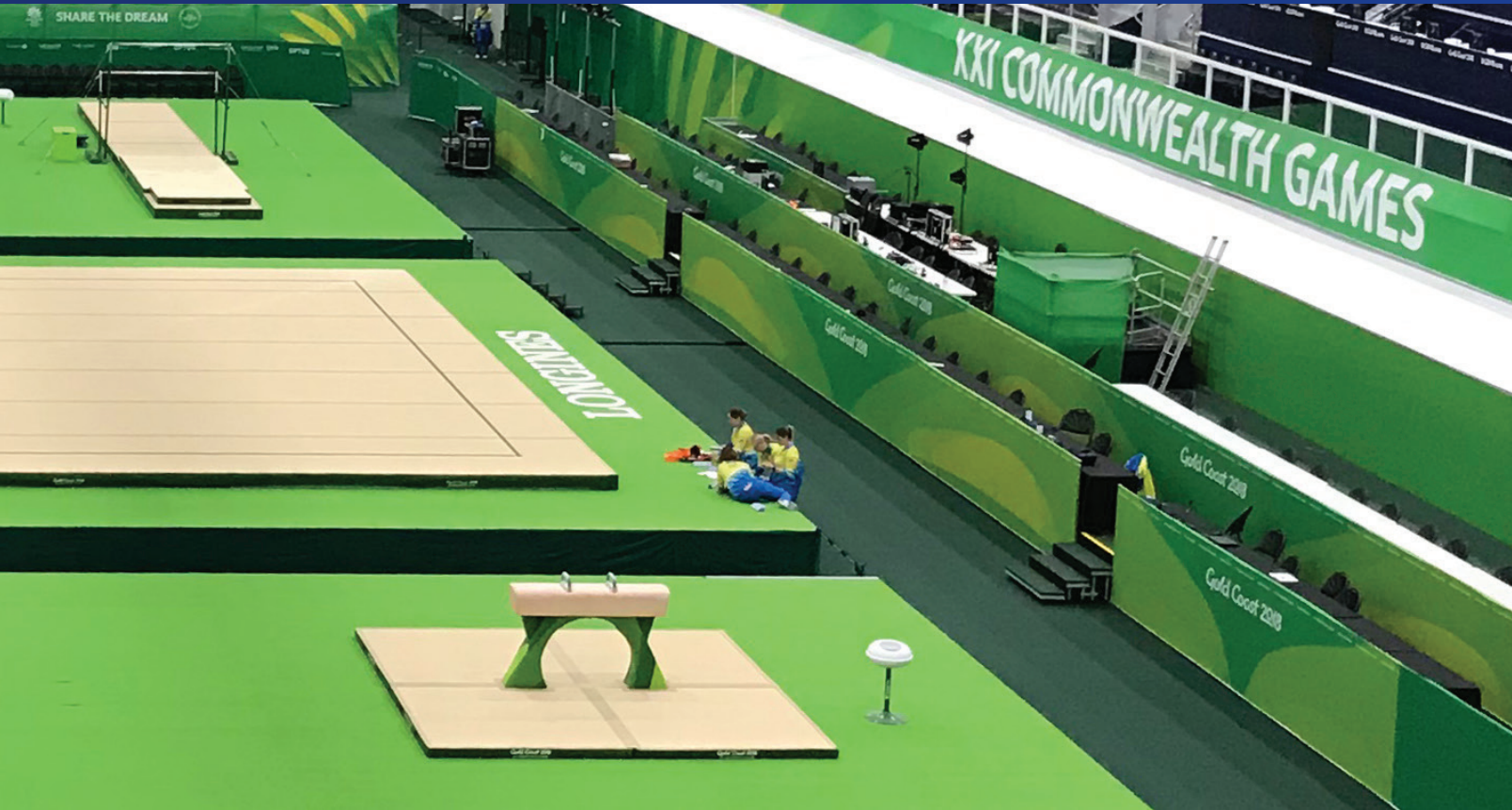

**NEW!**

## MAGNESIUM CARBONATE | CHALK UP WITH SPIETH AMERICA



### MAGNESIUM CARBONATE | CHALK

- Structure and composition are specially developed for gymnastics, rock climbing, cross-fit, and weight lifting
- Made in Taiwan

**1389153** Magnesia Stand "Munich"

**5191-000** Chalk Bowl with Stand

**186T** Gymnastics Chalk



### KIP GRIP

Men & Women's Uneven Buckle & Velcro

- Narrow Cut for Small Hands
- Single Buckle Leather Cuff or Velcro
- Sewn & Glued Dowel
- Grip Keeper
- Sold in Pairs



Men's High Bar

Size | Measurement

|           |        |
|-----------|--------|
| <b>00</b> | 4 1/4" |
| <b>0</b>  | 4 5/8" |
| <b>1</b>  | 5 1/8" |

Men's Rings

Size | Measurement

|           |        |
|-----------|--------|
| <b>00</b> | 5 3/8" |
| <b>0</b>  | 5 3/4" |
| <b>1</b>  | 8 3/8" |

Women's

Size | Measurement

|            |        |
|------------|--------|
| <b>000</b> | 5"     |
| <b>00</b>  | 5 3/8" |
| <b>0</b>   | 5 7/8" |
| <b>1</b>   | 6 1/8" |
| <b>2</b>   | 6 3/8" |
| <b>3</b>   | 6 3/4" |

Important: Sizing can be different from grip to grip. We recommend this hand grip for athletes that are between 70 lbs. and 120 lbs., level 7 or over. We do not recommend this grip for gymnasts whose body weight exceeds 120 lbs! These gymnasts should be using a grip such as our RKO models, which have a wider palm piece providing more strength. To order the Kip Grip please measure from the base of the wrist to the tip of the tallest finger. To order the Men's High Bar and Women's Kip Grip please measure from the base of the wrist to the tip of the tallest finger, and to order the Men's Ring Kip Grip please measure from the base of the wrist to the center of the middle finger between the 1st and 2nd knuckle..

### MEN'S EURO RING GRIP

Velcro & Buckle

- Swiss Style Cut
- Buckle Closure
- Sewn & Glued Leather Dowel
- Sold in Pairs



Size | Measurement

|    |        |
|----|--------|
| 00 | 5 3/8" |
| 0  | 5 3/4" |
| 1  | 6 3/8" |
| 2  | 6 5/8" |
| 3  | 7 1/8" |
| 4  | 7 1/2" |

Important: Sizing is different from grip to grip. Please make sure you're ordering the correct size for your grip!  
To order the Elite Ring Buckle Grips, take a measurement, in inches, from the wrist to tip of the middle finger.

### MEN'S EURO HIGH BAR GRIP

Velcro & Buckle

- Swiss Style Cut
- Velcro Closure
- Sewn & Glued Dowel
- Sold in Pairs



Size | Measurement

|    |        |
|----|--------|
| 00 | 4 1/4" |
| 0  | 4 5/8" |
| 1  | 5 1/8" |
| 2  | 5 1/2" |
| 3  | 5 7/8" |
| 4  | 6 1/4" |

Important: Sizing is different from grip to grip. Please make sure you're ordering the correct size for your grip!  
To order the Men's RKO High Bar Grips, take a measurement, in inches, from the wrist to center of the middle finger between 1st and 2nd joint.

### WOMEN'S EURO GRIP

Velcro & Buckle

- Swiss Style
- Buckle Closure
- Sewn & Glued Leather Dowel
- Sold in Pairs



Size | Measurement

|    |          |
|----|----------|
| 00 | 5 5/8"   |
| 0  | 6"       |
| 1  | 6 3/8"   |
| 2  | 6 5/8"   |
| 3  | 7 15/16" |
| 4  | 7 5/16"  |

Information: Sizing is different from grip to grip. Please make sure you're ordering the correct size for your grip!  
To order the RKO uneven bar grips, take a measurement, in inches, from the wrist to tip of the middle finger.

### WOMEN'S AMERICAN GRIP

Velcro & Buckle

- Slight Bow Cut
- Buckle Closure
- Heavy Duty Plastic Dowel
- Sold in Pairs



Size | Measurement

|    |        |
|----|--------|
| 00 | 5 3/8" |
| 0  | 5 7/8" |
| 1  | 6 1/8" |
| 2  | 6 3/8" |
| 3  | 6 3/4" |
| 4  | 7 1/8" |

Sizing can be different from grip to grip. Please make sure you're ordering the correct size for your grip!  
To order Uneven Buckle Grips, take a measurement, in inches, from the wrist to tip of the middle finger.

## SOCKETS & ANCHORS

Anchor  
[PEA1] set of 4



Threaded Socket  
[181]



Hook Plate Socket  
[122]



Swivel Anchor with  
Quick Link Attachment  
[184B]



Floor Springs & Caps,  
plus hardware  
[149A]



## VAULT TABLES AND SPRING BOARDS

Crank Handle For Balance  
Beams (5121-120 & 335)  
[P113-39A]



"Soft" Spring for  
334J, 5002-334, 338  
Vault Boards  
[P334-3]



"Hard" Spring for  
5002-334 Vault  
Board  
[P334-3M]



Ratchet and Bushing for  
Ergojet Vault Table  
[S1407210-110]



Pull Pin for Ergojet  
Vault Table  
[S1407210-120]



## UNEVEN BARS AND TRAINING BARS

Uneven Bar  
Carboflex Rail  
[2204130]



121PB Uneven Bar  
Rail - Pin Style  
[P121-99A]



Natural Fiber Competition  
Rail [GN3265]



Natural Fiber Training Rail  
[GN3268]



6-ACSYS Cable  
System- cables only  
[5103-000]



Fast Height Adjusting Pin  
for 121PB (set of 4)  
[P121-126A]



Swivel Spinlock for 228  
and 5101  
[P228-170A]



Cable Tighteners  
(set of 4)  
[P127-B]



Gravity Locking  
Load Binder  
[5173-004]



Uneven Bar  
Standard Cables  
[5101-001-001]



## BALANCE BEAMS

End Caps for Non-  
Crank Flex Beams  
[P111-60PR] pair



End Caps  
for Crank Beams  
[P113-60PR] pair



Rubber Foot Cup  
[PEKY-014A] set of 4



Removable Beam Cover  
[GN3652]



Beam Recovery Kit  
[120KN]

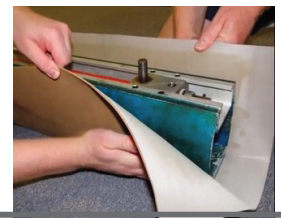

**MEN'S APPARATUS**

Men's Steel Rail for  
GN3020 and 5176-010  
High Bars [GN3110]



Men's Steel Rail for  
136A High Bar  
[P136-10A]



Men's Steel Rail for  
1384214 High Bar  
[4140090]



Men's Parallel Bar Rail  
for GN3832 Parallel Bars  
[GN3862]



Men's Parallel Rail  
for 1403104 Parallel Bars  
[2202555]



Men's Steel Rail for  
Freestanding Uneven  
Bars and Methodical Bar  
[4140705]



**JUST FOR KIDS**

Spin-Snap Lock  
[P355-254A]



Fiberglass Rail  
[355-65]



Composite Rail  
[355-64]



Base End Caps  
[P355-BEC] pair



Base Foot Pad  
[P355-BFP] pair



Uprights  
[355-35] pair



Base Assembly  
[355-01] pair



Cross Bar Tube  
[355-360]



Low Bar Adjusting Tube  
[355-62]



High Bar Adjusting Tube  
[355-57]



Ring Frame Adjusting Tube  
(includes rings) [355-105]



Ball Knob  
[P164-25PR] pair

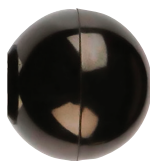

DON'T SEE THE PART YOU ARE LOOKING FOR? CONTACT YOUR SA  
DEALER OR OFFICE FOR ASSISTANCE.  
VISIT WEBSITE SPIETHAMERICA.COM



**SPIETH**  
A M E R I C A

WHERE INNOVATION MEETS GYMNASTICS

## Spieth America Locations

### United States of America

2119 S Old US 27, Suite C  
St. Johns, Michigan 48879

**Toll Free:** 800.331.8068  
**Phone:** 517.999.8230

### Canada and International

135 Forestview Rd.  
Oro-Medonte, Ontario L3V 0R4

**Toll Free:** 800.563.6479  
**Phone:** 705.325.2274

© 2019 Spieth Anderson International Inc. All rights reserved. Spieth America makes every possible effort to ensure the accuracy of our print literature. However, errors can happen from time to time and we sincerely regret any inconvenience they may cause. If you notice an error, please bring it to our attention and we will have it corrected at the next printing.



**/SPIETHAMERICA**