

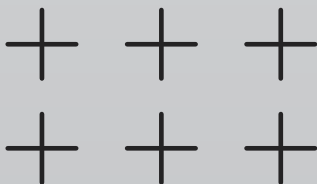

2023 SPRING DEALER WORKBOOK





GLOVES **SEC. 01**

BASEBALL GLOVES	01
FASTPITCH GLOVES	22
SLOWPITCH GLOVES	28
GLOVE CARE	28

LOVE THE MOMENT **SEC. 01**

WILSON BASEBALL GLOVES	21
------------------------	----

BATS **SEC. 02**

BASEBALL BATS	29
FASTPITCH BATS	42
SLOWPITCH BATS	47
WOOD BATS	49

PROTECTIVE GEAR **SEC. 03**

CATCHER'S GEAR	59
UMPIRE GEAR	67
PROTECTIVE GEAR	70
BATTING HELMETS	79
BATTING GLOVES	83

GEAR BAGS **SEC. 04**

EVOSHIELD	86
DEMARINI	91
LOUISVILLE SLUGGER	94
WILSON	95

BALLS **SEC. 05**

BASEBALLS	97
SOFTBALLS	102
SLOWPITCH BALLS	105

ATEC **SEC. 06**

ATEC	107
------	-----

UNIFORM & APPAREL **SEC. 07**

BASEBALL STOCK UNIFORMS	118
BASEBALL TEAM APPAREL	125
FASTPITCH STOCK UNIFORMS	142
FASTPITCH TEAM APPAREL	148
EVOSHIELD HATS	158

TABLE OF CONTENTS





WILSON®
BASEBALL
GLOVES

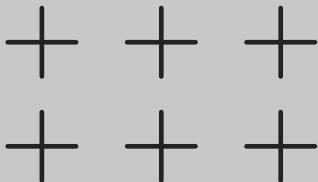

PRO STOCK® GLOVES

Pro Stock® patterns used by the pros. The best ball glove materials out there. Glove craftsmen devoted to hand crafting the best gloves in the game. It's no surprise that big leaguers choose Wilson® to get them through a 162-game season. The same patterns, materials and craftsmanship go into every Wilson Pro Stock glove whether it's made for play on the game's biggest stage or your local diamonds. For the pros. By the pros.



















SIZE	PATTERN	A2K®	A2K® SUPERSKIN™	A2000®	A2000® SUPERSKIN™	A2000® PEDROIA FIT™	A2K® & A2000® SPIN CONTROL
INFIELD							
11"	PFX2						
11.25"	PF88						
11.5"	OA1GM						
11.5"	DP15						
11.5"	DP15LTM						
11.5"	1716						
11.5"	1786						
11.5"	LTM86						
11.5"	TA7GM						
11.5"	PP05						
11.75"	1787						
11.75"	KBH13GM						
11.75"	1975						
11.75"	1785						
12'	1912						
1ST BASE							
11.75"	1620						
12'	JAB79/1679						



NEW FOR 2022



GAME MODEL

SIZE	PATTERN	A2K®	A2K® SUPERSKIN™	A2000®	A2000® SUPERSKIN™	A2000® PEDROIA FIT™	A2K® & A2000® SPIN CONTROL
OUTFIELD							
12.25"	PF92LTM					 	
12.5"	MB50GM		  				
12.75"	1799				 		
12.75"	OT7						 
12.75	1810		 		 		
12.75	JS22GM	  					
PITCHER							
11.5"	PF89						 
11.75"	CK22			 			
11.75"	D33	 					
12"	B2						
12"	B2LTM				 		
CATCHER							
33"	PF33				 		
33"	LTM CM33 CM33				 		
33.5"	M1D						   
33.5"	M2				 		
34"	1790				 		

GET A GRIP WITH

SPIN CONTROL[®]

TECHNOLOGY

A **PATENTED** surface texture in our iconic Pro Stock[®] Leather designed to increase friction between the ball and your glove.

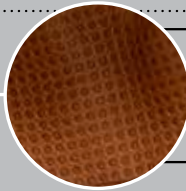

IT'S THE SAME PRO STOCK LEATHER YOU KNOW & LOVE IN A WILSON GLOVE ...



WITH DIMPLED TEXTURE ADDED TO THE PALM, FINGERS AND OCCASIONALLY THE WEB.

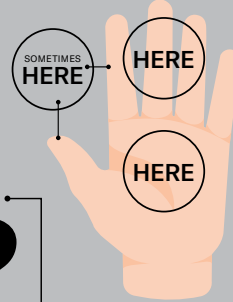

IN ADDITION TO OUR ON-FIELD WORK WITH BALLPLAYERS, WE'VE COLLABORATED WITH OUR PRO STOCK[®] LEATHER TANNERY AND AERODYNAMICS EXPERTS TO CREATE A2000[®] AND A2K[®] GLOVES THAT HELP PLAYERS CONTROL THE BALL WHILE MAKING PLAYS FASTER AND MORE CONSISTENTLY THAN EVER BEFORE.



WHAT DOES IT ALL MEAN?



Spin Control[®] Technology is designed to help you corral the ball and cleanly transfer it to your throwing hand so you can deliver it to your target with speed and precision.



WHAT MAKES THE SUPERSKIN[™]

SO SUPER?

SuperSkin[™] is a carefully tested and refined microfiber material, perfected to deliver ultimate durability at the lightest weight possible. It repels moisture to keep your glove from getting bogged down by the weight of rain or wet grass. For years, other manufacturers have tried to create their own version of SuperSkin[™] using ballistic nylon, molded materials and more — only to come up short time after time.

2X STRONGER

50% LIGHTER

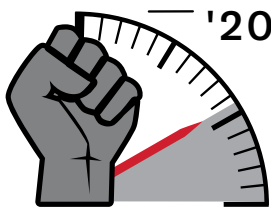

8 COLORS AVAILABLE

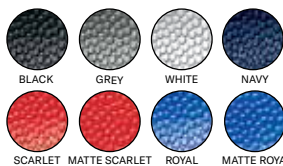

LIGHTER WEIGHT ENHANCES PERFORMANCE

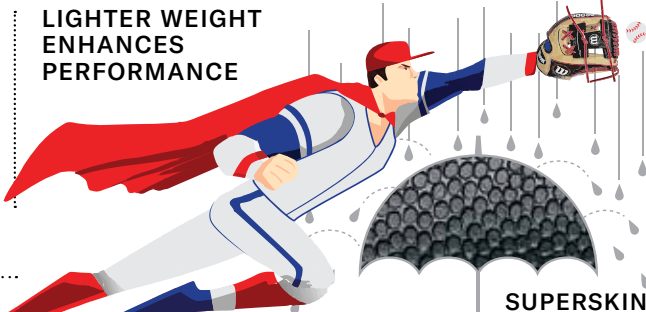

& INTRODUCING SUPERSNAKESKIN

1999 **2** PRO PLAYERS USING SUPERSKIN
PRESENT **>50%**

TIME TESTED

Since the 1990s, countless pros have sworn by their SuperSkin[™] gloves. Craig Counsell, who played 16 seasons in the Major Leagues, is just one example. Aso built him one of the first SuperSkin[™] gloves in 1999, and he used it until his retirement in 2011. "Craig Counsell loved the glove so much," Aso said.



SUPERSKIN REPELS MOISTURE

WILSON BALL GLOVE MASTER CRAFTSMAN

SHIGEAKI ASO

If you love what you do, you'll never work a day in your life. Few individuals in the world embody that expression as much as Aso, who has dedicated his life to the game he loves.

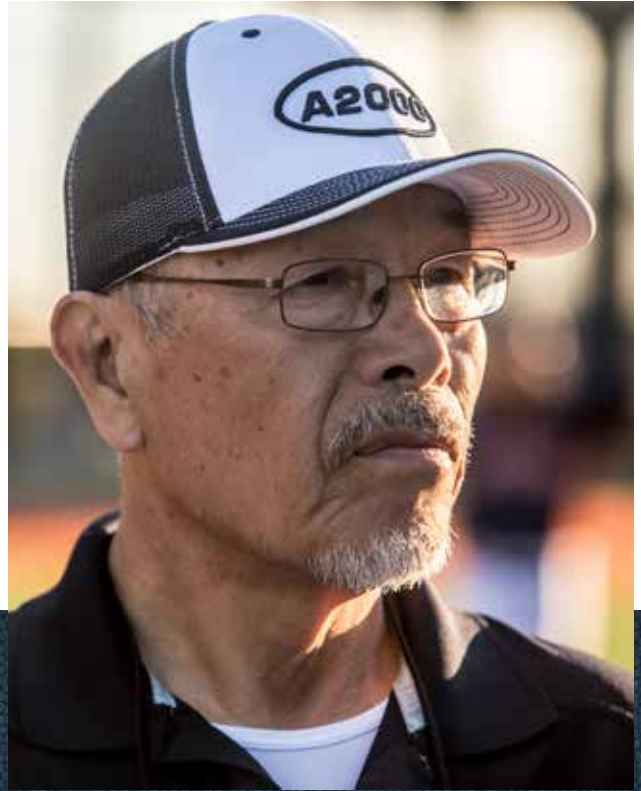

THAT'S MY GOAL. I DON'T WANT A PLAYER TO THINK ABOUT THEIR GLOVE AT ALL. HIS SMILE IS MY SMILE. IF HE SMILES, I CAN SMILE.



- Shigeaki Aso

Wilson Baseball Master Craftsman Shigeaki Aso has revolutionized the game for generations of players. His initial impact on the highest level of the game came in 1986 when he visited pro camps for the first time. With his decades of industry experience working with hides and leather quality control, he immediately noticed how common infield patterns featured long pinky and thumb stalls that were cumbersome to players.

He gathered feedback from as many players as he could find. One year later, he returned with what is, to this day, the most popular Wilson pattern — the A2000® 1786. From there, Aso developed the A2000® 1787 and A2000® 1788, launching a legendary journey of creating ball gloves.

Aso's initial iconic glove patterns were just the first innovations to come from his relationships with players. Aso has put in countless hours with some of the best to ever set foot on the field. Those collaborative efforts continue to this day with elite talents like Mookie Betts, Tim Anderson and Clayton Kershaw.

Aso credits the still-present language barrier between himself and big leaguers for his detailed understanding of what players are looking for in their gloves.

"I'm not a very good English speaker, which is why I ask questions again and again to players," Aso said. "They explain very honestly what they want. If I spoke English better, would they explain things so well to me? But they make sure to explain everything well because that means they'll get a great glove."

These conversations lead to the constant evolution of Wilson ball gloves, from the groundbreaking development of SuperSkin™ to more recent designs like Flat Finger Binding and Fastpitch-specific patterns and features. All these innovations share one common goal — ensuring that a player never has to think about their glove. It serves as an extension of the athlete, not an accessory.

A2K®



JUAN SOTO

District Dynamo. Juan Soto and his A2K® JS22 GM make it look easy on the outfield grass. With Blonde and Navy Blue Pro Stock® Select Leather and a sturdy Dual Post Web, Soto's 12.75" gamer is built to reach every fly ball.

OUTFIELD 12.75"

SKU

WBW1010101275

WBW1010111275 [LHT]

MSRP

\$399.95

JUAN'S GLOVE FEATURES

- Dual Post Web
- Blonde and Navy Blue Pro Stock® Select Leather
- Game Model of Juan Soto-A2K JS22 GM



ALL EYES ON 22

JUAN SOTO
A2K JS22 GM

PURSUING PERFECTION

Wilson® Game Model gloves aren't just worn by professionals. They're designed by them. Wilson Ball Glove Master Craftsman Shigeaki Aso sits down with select Advisory Staff members — either in person or on a video call — to craft a Game Model glove designed specifically for their play.

Aso's relentless passion drives his pursuit of the perfect glove. He collaborates with players to receive detailed feedback and ensure each glove is built to work for the player's game. Every glove has unique features, from the laces to the webbing and even the materials used, culminating in an innovative line of Wilson Game Model gloves.

A2K® GAME MODEL GLOVES



NEW
GM

MOOKIE BETTS

Ready to rob homers and steal the spotlight, the A2K® MB50 GM was meticulously designed for Mookie Betts. This 12.5" model with a narrower heel offers more control on the outfield grass. The Pro Stock® Select Leather palm and Dual Post Web pairs with a SuperSkin™ shell for a lightweight outfield pattern.

OUTFIELD 12.5"

SKU

WBW101012125

WBW101015125 [LHT]

MSRP

\$399.95

MOOKIE'S GLOVE FEATURES

- Dual Post Web
- Royal Blue Pro Stock® Select Leather and SuperSkin™
- Game Model of Mookie Betts–A2K MB50 GM



GM

OZZIE ALBIES

Fortune favors the bold, the risk-takers, the ones who pour their heart and soul into their craft. Atlanta second baseman Ozzie Albies and his custom A2K OA1 GM, featuring Red Pro Stock® Select Leather and Bold Wilson Yellow logos, are ready to reign supreme with a revamped squad this season.

INFIELD 11.5"

SKU

WBW100234115

MSRP

\$399.95

OZZIE'S GLOVE FEATURES

- H-Web
- Red Pro Stock® Select Leather with Yellow Accents
- Game Model of Ozzie Albies–A2K OA1 GM



GM

JOSÉ ABREU

A new era is dawning on the South Side. Chicago first baseman Jose Abreu is ready to lead his club this season with the all-new A2K® JAB79 GM, designed with Black SuperSnakeSkin, Blonde Pro Stock® Select Leather, a one-of-a-kind personalized Single Post Web and revolutionary Spin Control® Technology.

1ST BASE 12.5"

SKU

WBW100233125

WBW100232125 [LHT]

MSRP

\$399.95

JOSÉ'S GLOVE FEATURES

- Single Post Web
- Black Spin Control® Palm with Black SuperSnakeSkin™ Back and Blonde Accents
- Game Model of José Abreu–A2K JAB79 GM

A2000® GAME MODEL GLOVES



GM

CLAYTON KERSHAW

Perhaps the greatest pitcher of his generation, Clayton Kershaw continues to dominate. For every win, Cy Young Award and postseason appearance, the left-hander has donned the same clean, classic A2000 CK22 GM with Black Pro Stock and iconic gold logos.

PITCHER 11.75"

SKU

WBW1002361175

WBW1002371175 [LHT]

MSRP

\$299.95

CLAYTON'S GLOVE FEATURES

- Closed Two-Piece Web
- Black Pro Stock® Leather with Gold Accents
- Game Model of Clayton Kershaw–A2000 CK22 GM



GM

SS

TIM ANDERSON

Tim Anderson is always looking to bring some flair to his game on Chicago's south side, and his A2000® TA7 GM is here to make a statement on the field. Black and Grey SuperSnakeSkin™ reduces glove weight while enhancing durability, and the Reinforced H-Web helps corral the ball all over the infield.

INFIELD 11.5"

SKU

WBW101019115

MSRP

\$299.95

TIM'S GLOVE FEATURES

- Reinforced H-Web
- Grey Pro Stock® Leather and Black & Grey SuperSnakeSkin™
- Game Model of Tim Anderson–A2000 TA7 GM



GM

KE'BRYAN HAYES

Ke'Bryan Hayes and his 2022 A2000® KBH13 GM glove are ready to handle the hot corner in Pittsburgh. The Black SuperSnakeSkin™ back cuts glove weight while improving durability and moisture resistance. Built with Wilson's iconic H-Web, this 11.75" game model has the extra length third basemen prefer, and Flat Finger Binding allows you to comfortably keep a finger out for more control when making plays.

INFIELD 11.75"

SKU

WBW1004321175

MSRP

\$299.95

KE'BRYAN'S GLOVE FEATURES

- H-Web
- Black Pro Stock® Leather with Blonde Accents
- Black SuperSnakeSkin
- Game Model of Ke'Bryan Hayes – A2000 KBH13 GM

A2K[®]

THE LEGENDARY A2K

Meticulously engineered, the A2K[®] is unrivaled among ball gloves. No detail is too small to Wilson Master Craftsman Shigeaki Aso and the experts who designed the A2K[®] for elite players, using the most premium materials and innovative technologies available in modern ball gloves. Flawless Pro Stock[®] Select leather is sorted three times to remove blemishes or imperfections, and each A2K[®] features Double Palm Construction—a strategically placed layer of leather in the palm to stabilize and maintain the pocket. Rolled Dual Welting reinforces the glove's shape, and innovations like lightweight SuperSkin[™] and patented Spin Control Technology[™] offer extra advantages on the field.

1.

PRO STOCK[®] SELECT LEATHER:

Wilson craftsmen triple-sort Pro Stock[®] Select Leather hides for consistency and flawlessness, using only the top five percent of materials in A2K ball gloves. The result is an incomparable break-in and long-lasting shape.

2.

ROLLED DUAL WELTING[™]:

Strips of Pro Stock[®] Select Leather are skived thin and rolled to provide the glove's long-lasting shape.

3.

DOUBLE PALM CONSTRUCTION:

A thin, perfectly shaped piece of leather placed between the palm and interior liner generates maximum pocket stability.

4.

THREE TIMES MORE SHAPING:

Expert glove craftsmen spend three times longer pounding and shaping the A2K[®] by hand, helping reduce break-in time.



SC



INFIELD 11.5"

SKU
WBW100409115
MSRP
\$399.95

- A2K SC1786
- H-Web
- Blonde/Gunmetal Pro Stock® Select Leather
- Spin Control® Dimpled Palm

NEW

SS



INFIELD 11.5"

SKU
WBW100890115
MSRP
\$399.95

- 2023 A2K 1786SS
- H-Web
- Black Superskin™/Grey Pro Stock® Select Leather

GM



INFIELD 11.5"

SKU
WBW100234115
MSRP
\$399.95

- A2K OA1 GM
- H-Web
- Red Pro Stock® Select Leather with Yellow Accents
- Game Model of Ozzie Albies

NEW

SC

SS



INFIELD 11.75"

SKU
WBW1008921175
MSRP
\$379.95

- 2023 A2K SC1787SS
- H-Web
- Black Superskin™/White Pro Stock® Select Leather

NEW



INFIELD 11.75"

SKU
WBW1008911175
MSRP
\$399.95

- 2023 A2K 1787
- H-Web
- Vintage Tan Pro Stock® Select Leather

NEW



PITCHER 11.75"

SKU
WBW1008931175
WBW1008941175 (LHT)
MSRP
\$399.95

- 2023 A2K D33
- D1 Web
- Vintage Tan Pro Stock® Select Leather

NEW

GM



OUTFIELD 12.5"

SKU
WBW101012125
WBW101015125 (LHT)
MSRP
\$399.95

- A2K MB50 GM
- Dual Post Web
- Royal Blue Pro Stock® Select Leather and Superskin™
- Game Model of Mookie Betts

NEW

SC

SS



OUTFIELD 12.75"

SKU
WBW1008951275
WBW1008961275 (LHT)
MSRP
\$399.95

- 2023 A2K 1810SS
- Single Post w/ V Center Lace
- Black Superskin™/Vintage Tan Pro Stock® Select Leather

NEW

GM



OUTFIELD 12.75"

SKU
WBW101012125
WBW1010111275 (LHT)
MSRP
\$399.95

- A2K JS22 GM
- Dual Post Web
- Navy Blue/Blonde Pro Stock® Select Leather
- Game Model of Juan Soto

NEW



CATCHER 33.5"

SKU
WBW100897335
MSRP
\$399.95

- A2K M1DSS
- Half Moon Web
- Black SuperSnakeSkin™/Vintage Tan Pro Stock® Select Leather

GM



1ST BASE 12.5"

SKU
WBW100233125
WBW100232125 (LHT)
MSRP
\$399.95

- A2K JAB79 GM
- Single Post Web
- Black Spin Control® with Black SuperSnakeSkin™ Back and Blonde Accents
- Game Model of Jose Abreu

A2000®

THE PREMIER GLOVE

Since its introduction in 1957, the A2000® has evolved with the game year after year. Durable Pro Stock® leather offers a consistent feel and allows for a detailed break-in process. Comfort Pro Fit features a supple leather Comfort Sleeve in the wrist binding and a Pro Lux™ leather palm lining that forms to the player's hand over time, making the A2000 feel like an extension of the body. Flat Finger Binding allows players to comfortably take the field with a finger outside the glove for improved control, and the Bold Logo package is built to stand out. The A2000® lineup includes patterns with innovations like SuperSkin™, Spin Control® Technology and Pedroia Fit™, ensuring there is an option for every player.

1.

PRO STOCK® LEATHER:

Wilson's iconic Pro Stock® leather is preferred for its rugged durability and unmatched feel.

2.

COMFORT PRO FIT:

The Comfort Sleeve embedded in the wrist is paired with Pro Lux™ Leather lining, creating a rich, soft feel that molds to a player's hand over time.

3.

FLAT FINGER BINDING:

Flattened wrist binding allows players to comfortably take the field with a finger outside the glove, allowing for improved control.

4.

ROLLED DUAL WELTING:

Integrated into the interior of Wilson gloves, Rolled Dual Welting supports the leather to help a glove keep its shape over time.





INFIELD 11.5"
 SKU
 WBW100389115
 MSRP
 \$299.95

- A2000 1716
- H-Web
- Black/Copper Pro Stock® Leather



INFIELD 11.5"
 SKU
 WBW100969115
 MSRP
 \$299.95

- 2023 A2000 1786
- H-Web
- Blonde Pro Stock® Leather

NEW



INFIELD 11.5"
 SKU
 WBW100845115
 MSRP
 \$299.95

- 2023 A2000 LTM 1786
- H-Web
- Autism Speaks Blue Pro Stock® Leather



INFIELD 11.5"
 SKU
 WBW100087115
 MSRP
 \$299.95

- A2000 PP05
- Dual Post Web
- Copper/Blonde Pro Stock® Leather

NEW



INFIELD 11.75"
 SKU
 WBW1009701175
 MSRP
 \$299.95

- 2023 A2000 1975
- H-Web
- Black/White/Red Pro Stock® Leather

GM



PITCHER 11.75"
 SKU
 WBW1002361175
 WBW1002371175 [LHT]
 MSRP
 \$299.95

- A2000 CK22GM
- Closed Two-Piece Web
- Pro Stock® Leather with Gold Accents
- Game Model of Clayton Kershaw



PITCHER 11.75"
 SKU
 WBW1003921175
 WBW1003931175 [LHT]
 MSRP
 \$299.95

- A2000 D33
- Closed Pro Laced Web
- Vintage Tan Pro Stock® Leather

NEW



PITCHER 12"
 SKU
 WBW10084612
 WBW10084712 [LHT]
 MSRP
 \$299.95

- 2023 A2000 LTM B2
- 2-Piece Web
- Autism Speaks Blue Pro Stock® Leather



OUTFIELD 12.75"
 SKU
 WBW1003941275
 WBW1003951275 [LHT]
 MSRP
 \$299.95

- A2000 1799
- Dual Post Web
- Blonde/Saddle Tan Pro Stock® Leather



A2000[®]

SUPERSKIN[™]

Wilson SuperSkin[™], developed by Master Glove Craftsman Shigeaki Aso, is the ultimate utility player in Pro Stock[®] gloves. The microfiber material is moisture resistant, extremely durable and half the weight of leather, offering players extreme command over their gloves.



SUPERSKIN[™]:

Twice as strong as traditional Pro Stock[®] leather and only half the weight.

REPELS MOISTURE:

Resistant to moisture, SuperSkin[™] extends the lifespan of the glove and prevents it from getting bogged down by the weight of rain or wet grass.

STRATEGIC DESIGN:

Glove craftsmen strategically place Pro Stock[®] leather and SuperSkin[™] to benefit players. Superskin material on the back of the glove reduces overall glove weight and is easy to maintain.



INFIELD 11.5"

SKU
WBW101019115
MSRP
\$299.95

- A2000 TA7 GM
- Reinforced H-Web
- Grey Pro Stock[®] Leather and Grey & Black SuperSnakeSkin[™]
- Game Model of Tim Anderson



INFIELD 11.5"

SKU
WBW100396115
MSRP
\$299.95

- A2000 1786SS
- H-Web
- Black Superskin[™]/Grey Pro Stock[®] Leather



INFIELD 11.75"

SKU
WBW1004321175
MSRP
\$299.95

- A2000 KBH13 GM
- H-Web
- Black Super SnakeSkin/Black Pro Stock[®] Select Leather with Blonde Accents
- Game Model of Ke'Bryan Hayes



INFIELD 11.75"

SKU
WBW1009711175
MSRP
\$299.95

- 2023 A2000 1785SS
- Cross Web w/ V Center Lace
- Grey Superskin[™]/Blonde/Red Pro Stock[®] Leather



INFIELD 12"

SKU
WBW10097212
MSRP
\$299.95

- 2023 A2000 1912SS
- Cross Web w/ 3X Lace
- Blonde Superskin[™]/Saddle Tan Pro Stock[®] Leather



PITCHER 12"

SKU
WBW10010012
WBW10010112 [LHT]
MSRP
\$299.95

- A2000 B2SS
- Closed Two-Piece Web
- Black Superskin[™]/Black/Blonde Pro Stock[®] Leather



OUTFIELD 12.75"

SKU
WBW1009751275
WBW1009761275 [LHT]
MSRP
\$299.95

- 2023 A2000 1799SS
- Dual Post Web
- Black Superskin[™]/Saddle Tan Pro Stock[®] Leather



OUTFIELD 12.75"

SKU
WBW1009731275
WBW1009741275 [LHT]
MSRP
\$299.95

- 2023 A2000 1810SS
- Single Post Web w/ V Center Lace
- Black Superskin[™]/Blonde Pro Stock[®] Leather

A2000[®]

SPIN CONTROL[®] TECHNOLOGY

Wilson gloves with Spin Control[®] Technology feature a patented surface texture in the same Pro Stock[®] leather that players know and love. This textured pattern can be found in the palm, web and other leather surfaces of the ball glove, helping to reduce the spin rate of the ball by generating friction on contact.



PATENTED SURFACE TEXTURE:
A patented surface texture is imprinted on Wilson's iconic Pro Stock[®] leather.

INCREASED FRICTION:
The dimpled surface texture is designed to increase friction between the ball and glove on contact, helping players to handle any hop and quickly transfer the ball to their throwing hand.

PRO CALIBER LEATHER:
Available on several A2000[®] models, Spin Control[®] Technology adds a patented surface texture to ball gloves crafted with premium materials.

- NEW
- SC
- SS



INFIELD 11.5"
SKU
WBW100985115
MSRP
\$299.95

- 2023 A2000 SC1786
- H-Web
- Black/White Tan Pro Stock[®] Leather
- Spin Control[®] Dimpled Palm

- SC



INFIELD 11.75"
SKU
WBW1004001175
MSRP
\$299.95

- A2000 SC1787
- H-Web
- Blonde/Saddle Tan Pro Stock[®] Leather
- Spin Control[®] Dimpled Palm

- NEW
- SC
- SS



INFIELD 11.75"
SKU
WBW1009861175
MSRP
\$299.95

- 2023 A2000 SC1975SS
- H-Web
- Black Superskin™/Grey/Red Tan Pro Stock[®] Leather
- Spin Control[®] Dimpled Palm

- NEW
- SC
- SS



OUTFIELD 12.75"
SKU
WBW1009871275
WBW1009881275 [LHT]
MSRP
\$299.95

- 2023 A2000 SCOT7SS
- Pro Laced 6 Finger
- Black Superskin™/White/Red Pro Stock[®] Leather
- Spin Control[®] Dimpled Palm



A2000[®]

PEDROIA FIT™

Find the glove to fit your game. Perfect for players with smaller hands, Wilson gloves with Pedroia Fit™ are designed with shorter finger stalls and a narrower wrist opening to create a secure feel. Pedroia Fit is available in several Pro Stock® models, so every position player can have a glove that fits their play.



SECURE FIT:

Designed for players with smaller hands, Pedroia Fit™ offers a secure feel.

INNOVATIVE DESIGN:

Pedroia Fit™ gloves feature shorter finger stalls and a narrower wrist opening than other pro caliber ball gloves, ensuring players with smaller hands have a well-fitting glove.

PRO STOCK® LEATHER:

Pedroia Fit™ is available in several Pro Stock® models, giving players plenty of options to find the perfect glove.

SS

PF



INFIELD 11"

SKU
WBW10039711

MSRP
\$299.95

- A2000 PFX2SS
- X2 Web
- Black Superskin™/Black Pro Stock® Leather

NEW

SS

PF



INFIELD 11.25"

SKU
WBW100981125

MSRP
\$299.95

- 2023 A2000 PF88SS
- H-Web
- Grey SuperSnakeSkin™/Blonde/Red Pro Stock® Leather

PF



INFIELD 11.5"

SKU
WBW100108115

MSRP
\$299.95

- A2000 DP15
- H-Web
- Saddle Tan Pro Stock® Leather

SS

PF

SC



INFIELD 11.5"

SKU
WBW100399115

MSRP
\$299.95

- A2000 DP15SS
- H-Web
- Black Superskin™/Blonde Pro Stock® Leather
- Spin Control® Dimpled Palm

NEW

SS

SC



INFIELD 11.5"

SKU
WBW100844115

MSRP
\$299.95

- 2023 A2000 LTM DP15SS
- H-Web
- LTM Blue Superskin™/LTM Blue Pro Stock® Leather

NEW

SC



PITCHER/INF 11.5"

SKU
WBW100982115
WBW100983115 [LHT]

MSRP
\$299.95

- 2023 A2000 PF89
- Pro Laced T-Web
- Saddle Tan/Blonde Pro Stock® Leather

NEW

SS



OUTFIELD 12.25"

SKU
WBW1008051225
WBW1008061225 [LHT]

MSRP
\$299.95

- 2023 A2000 LTM PF92
- Pro Laced T-Web
- LTM Blue Superskin™/Grey Pro Stock® Leather

A2000® MITTS



CATCHER 33"
 SKU
 WBW10011533
 MSRP
 \$299.95

- A2000 CM33
- Half Moon Web
- Blonde/Black Pro Stock® Leather



CATCHER 33"
 SKU
 WBW10084833
 MSRP
 \$299.95

- 2023 A2000 LTM CM33
- Half Moon Web
- LTM Blue Superskin™ / LTM Blue Pro Stock® Leather



CATCHER 33"
 SKU
 WBW10098433
 MSRP
 \$299.95

- 2023 A2000 PF33SS
- Half Moon Web
- Grey Superskin™ /Blonde Pro Stock® Leather



CATCHER 33.5"
 SKU
 WBW100977335
 MSRP
 \$299.95

- 2023 A2000 M2SS
- Half Moon Web
- Grey/Black Pro Stock® Leather



CATCHER 33.5"
 SKU
 WBW100995335
 MSRP
 \$299.95

- 2023 A2000 SCM1DSS
- Half Moon Web
- Black Superskin™ /White Pro Stock® Leather



CATCHER 34"
 SKU
 WBW10097834
 MSRP
 \$299.95

- 2023 A2000 1790SS
- Half Moon Web
- Blonde Superskin™ /Black Pro Stock® Leather



1ST BASE 12.5"
 SKU
 WBW100979125
 WBW100980125 [LHT]
 MSRP
 \$299.95

- 2023 A2000 1679SS
- Single Post Web
- Black Superskin™ /Blonde Pro Stock® Leather



1ST BASE 12.5"
 SKU
 WBW100119125
 WBW100120125 [LHT]
 MSRP
 \$299.95

- A2000 1620SS
- Single Post Web
- Grey Superskin™ /Black Pro Stock® Leather



1ST BASE 12.5"
 SKU
 WBW100123125
 WBW100124125 [LHT]
 MSRP
 \$299.95

- A2000 1620SS
- Single Post Web
- Black Superskin™
- Spin Control® Dimpled Palm



A1000®

BROKEN IN & READY TO GO

Grab your glove and get right to work. The A1000® baseball glove is game ready from day one thanks to its supple yet sturdy Full Grain leather construction. This series gives rising stars the comfort of a pro caliber glove without the meticulous break in process. All components are produced with form-fitting Full Grain leather, resulting in a glove that's easy to control.



DOUBLE PALM CONSTRUCTION (FRONT SIDE):

A thin, perfectly shaped piece of leather placed between the palm liner and outer shell, giving you what matters most: maximum pocket stability.

FULL LEATHER CONSTRUCTION:

Leather shell, laces and palm liner. These ball gloves expertly break in and conform to your hand.

LOW PROFILE HEEL (FRONT SIDE):

Gives more flexibility, opens up the palm and pocket and makes it more forgiving on bad hops.

OUTLINED LOGO PACKAGE:

Outfitted with the new outline logo package, the Wilson A1000 ball gloves stand out on the diamond.

PF



INFIELD 11"

SKU
WBW10013111

MSRP
\$149.95

- X2 Web
- Pedoria Fit™
- Black/Red/Grey Full Grain Optima Leather

PF



INFIELD 11.5"

SKU
WBW100132115
WBW100133115

MSRP
\$149.95

- H-Web
- Pedoria Fit™
- Black/Tropical/Blonde Full Grain Optima Leather



INFIELD 11.5"

SKU
WBW100134115

MSRP
\$149.95

- H-Web
- Grey/Black/Blonde Full Grain Optima Leather



INFIELD 11.75"

SKU
WBW1001351175

MSRP
\$149.95

- H-Web
- Grey/Blonde/Royal Full Grain Optima Leather



INFIELD 12"

SKU
WBW10013612
WBW10013712

MSRP
\$149.95

- Single Post 3X Web
- Black/Red/Blonde Full Grain Optima Leather

PF



OUTFIELD 12.25"

SKU
WBW1004071225
WBW1004081225

MSRP
\$149.95

- Single Post 3 Bar Web w/ Lacing
- Pedoria Fit™
- Black/White/Red Full Grain Optima Leather



OUTFIELD 12.5"

SKU
WBW100138125
WBW100139125

MSRP
\$149.95

- Dual Post Web
- Drawstring Closure
- Grey/Black/Blonde Full Grain Optima Leather



1ST BASE 12.5"

SKU
WBW100140125
WBW100141125

MSRP
\$149.95

- Single Post 3 Bar Web
- Black/Grey/White Full Grain Optima Leather



CATCHER 33"

SKU
WBW10014233

MSRP
\$149.95

- Half Moon Web
- Black/Blonde/White Full Grain Optima Leather

A700

GAME READY LEATHER

Born ready. Glove experts designed the A700™ to be lightweight for young players, and its Full Grain leather construction offers a soft feel without added bulk or any break-in required. Each glove comes equipped with a drawstring closure, ensuring a perfect fit for every player.



FULL GRAIN LEATHER:
The perfectly soft feel without added weight.

NO BREAK-IN:
Game ready on day one.

DRAWSTRING CLOSURE:
Make in-game glove adjustments on the fly and ensure a secure fit in the field. Pull the long rawhide lace to set your wrist closure into place for the perfect fit.



INFIELD 11.25"
SKU
WBW1001251125
MSRP
\$89.95

- H-Web
- Drawstring Wrist Closure
- Black/Red/Royal Full Grain Leather



INFIELD 11.5"
SKU
WBW100126115
MSRP
\$89.95

- H-Web
- Drawstring Wrist Closure
- Black/Red/Blonde Full Grain Leather



OUTFIELD 12"
SKU
WBW10012712
WBW10012812
MSRP
\$89.95

- Pro Laced T-Web
- Drawstring Wrist Closure
- Black/Red/White Full Grain Leather



OUTFIELD 12.5"
SKU
WBW100129125
WBW100130125
MSRP
\$89.95

- Single Post 3 Bar Web
- Drawstring Wrist Closure
- Black/Blonde/White Full Grain Leather



CATCHER 32.5"
SKU
WBW100429325
MSRP
\$94.95

- Half Moon Web
- Pedroia Fit™/Velcro®
- Black/Blonde Red Full Grain Leather



A500

FOR THE YOUNG SERIOUS PLAYER

For the game's youngest players, fit and feel are everything. The A500™ is the lightest all-leather glove in the game, and its youth-specific fit is designed for rising stars. Short, narrow finger stalls accommodate small hands, and the Quick-Fit Wrist elastic system adjusts to hug the wrist. Real leather laces improve durability, and Wilson's signature dual welting maintains the glove shape.



TOP GRAIN LEATHER:

All the feel without the weight.

REAL LEATHER LACES:

Tough and strong for maximum durability.

DOUBLE PALM CONSTRUCTION (FRONT SIDE):

A thin, perfectly shaped piece of leather placed between the palm liner and outer shell, giving you what matters most: maximum pocket stability.



ALL POSITIONS 10.5"

SKU
WBW100898105
MSRP
\$74.95

- Open Dual Post Web
- Black/Blonde/White
- Smaller hand opening for a more snug fit



ALL POSITIONS 11"

SKU
WBW10089911
WBW10090011
MSRP
\$74.95

- H-Web
- Blonde/Red White
- Smaller hand opening for a more snug fit



ALL POSITIONS 11.5"

SKU
WBW100901115
WBW100902115
MSRP
\$74.95

- H-Web
- Black/Blonde/Red
- Smaller hand opening for a more snug fit



ALL POSITIONS 12"

SKU
WBW10090312
WBW10090412
MSRP
\$74.95

- Open Dual Post Web
- Blonde/Red/Royal
- Smaller hand opening for a more snug fit



ALL POSITIONS 12.5"

SKU
WBW100905125
WBW100906125
MSRP
\$74.95

- Open Single Post Web
- Black/Grey/Tropical Blue
- Smaller hand opening for a more snug fit



ALL POSITIONS 32"

SKU
WBW10090733
MSRP
\$79.95

- Closed One-Piece Web
- Black/Grey/Red
- Smaller hand opening for a more snug fit

A450®



INFIELD 10.75"

SKU
WBW1001711075
MSRP
\$49.95

- H-Web
- New Quick-Fit Wrist
- Grey/Black/White



INFIELD 11"

SKU
WBW10017211
WBW10017311 (LHT)
MSRP
\$49.95

- Dual Post Web
- New Quick-Fit Wrist
- Black/Blonde/White



INFIELD 11.5"

SKU
WBW100174115
WBW100175115
MSRP
\$49.95

- H-Web
- New Quick-Fit Wrist
- Black/Blonde/Red



OUTFIELD 12"

SKU
WBW10017612
WBW10017712 (LHT)
MSRP
\$49.95

- Dual Post Web
- New Quick-Fit Wrist
- Black/Royal/Red

A360®



ALL POSITIONS 12"

SKU
WBW10018712
WBW10018812 (LHT)
MSRP
\$49.95

- 2-Piece Web
- Grey/Black CarbonLight™ Material
- Youth Pattern



ALL POSITIONS 12.5"

SKU
WBW100189125
WBW100246125 (LHT)
MSRP
\$49.95

- 2-Piece Closed Weave Web
- Grey/Black CarbonLight™ Material
- Youth Pattern



CATCHER 31.5"

SKU
WBW100190315
WBW100191315 (LHT)
MSRP
\$54.95

- Half Moon Web
- Grey/Black CarbonLight™ Material
- Youth Pattern

A200® EZ CATCH



ALL POSITIONS 10"

SKU
WBW10090810
MSRP
\$24.95

- H-Web
- Designed w/Smaller Hand Opening for Better Fit
- Design to Assist Young Players w/ Grounders & Pop Ups
- White/Black/Purple



ALL POSITIONS 10"

SKU
WBW10045410
MSRP
\$24.95

- H-Web
- Designed w/Smaller Hand Opening for Better Fit
- Design to Assist Young Players w/ Grounders & Pop Ups
- Black/Red



ALL POSITIONS 10"

SKU
WBW10045510
MSRP
\$24.95

- H-Web
- Designed w/Smaller Hand Opening for Better Fit
- Design to Assist Young Players w/ Grounders & Pop Ups
- Royal/Red/White

NEW



ALL POSITIONS 12"

SKU
WBW10090810
MSRP
\$24.95

- H-Web
- Designed w/Smaller Hand Opening for Better Fit
- Design to Assist Young Players w/ Grounders & Pop Ups
- Special collaboration with Autism Speaks



TRAINING

TAKE YOUR GAME TO THE NEXT LEVEL

The training glove lineup is designed to help players step up their defensive play, no matter their position on the diamond. Crafted with Full Grain leather, these training gloves mirror A2000® glove patterns in smaller sizes to help players shore up their defensive skills.



FULL GRAIN LEATHER CONSTRUCTION:
Soft feel without unnecessary bulk.

DRAWSTRING CLOSURE:
Make quick adjustments on the fly and ensure a secure fit on the field. Pull the rawhide laces to set your wrist closure into place.

A2000 PATTERNS:
Smaller versions of the pro style gloves players love.



INFIELD PANCAKE

SKU
WBW100997275
MSRP
\$79.95

• Black/White/Red



INFIELD 10"

SKU
WBW10090910
MSRP
\$119.95

• Black/White/Red



CATCHER 30"

SKU
WBW10099630
MSRP
\$119.95

• Black/White/Red



1ST BASE 11"

SKU
WBW10091011
WBW10099811 [LHT]
MSRP
\$119.95

• Black/White/Red

Teaming up once again, Wilson® has created several products in partnership with Autism Speaks®. The organizations collaborated to create Love the Moment® bats and gloves that exist to spread the message of inclusion, acceptance and understanding for people on the autism spectrum. This collection perfectly showcases Autism Speaks' signature blue color and Love the Moment branding developed specifically for this partnership.

NEW



INFIELD 11.5"
 SKU
 WBW100845115
 MSRP
 \$299.95

- 2023 A2000 LTM 1786
- H-Web
- Autism Speaks Blue Pro Stock® Leather

NEW

SS
SC



INFIELD 11.5"
 SKU
 WBW100844115
 MSRP
 \$299.95

- 2023 A2000 LTM DP15SS
- H-Web
- LTM Blue Pro Stock® Leather

NEW



PITCHER 12"
 SKU
 WBW10084612
 WBW10084712 (LHT)
 MSRP
 \$299.95

- 2023 A2000 LTM B2
- 2-Piece Web
- Autism Speaks Blue Pro Stock® Leather

NEW

SS



OUTFIELD 12.25"
 SKU
 WBW1008051225
 WBW1008061225 (LHT)
 MSRP
 \$299.95

- 2023 A2000 LTM PF92
- Pro Laced T-Web
- LTM Blue Pro Stock® Leather

NEW



CATCHER 33"
 SKU
 WBW10084833
 MSRP
 \$299.95

- 2023 A2000 LTM CM33
- Half Moon Web
- Autism Speaks™ Blue

NEW



ALL POSITIONS 12"
 SKU
 WBW10090810
 MSRP
 \$21.95

- H-Web
- Designed w/Smaller Hand Opening for Better Fit
- Design to Assist Young Players w/ Grounders & Pop Ups
- Special collaboration with Autism Speaks

LOVE THE MOMENT

FASTPITCH GLOVES



**WILSON[®]
FASTPITCH
GLOVES**

2023

@WILSONBALLGLOVE

#TEAMWILSON

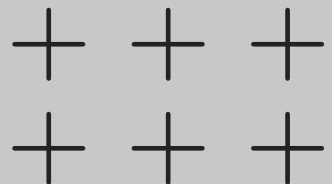



FASTPITCH GAME MODEL GLOVES

FOR THE PROS, BY THE PROS

Wilson Game Model gloves aren't just worn by professionals. They're designed by them. Wilson Ball Glove Master Craftsman Shigeaki Aso sits down with select Advisory Staff members — either in person or on a video call — to craft a Game Model glove designed specifically for their play.



NEW
GM

SIS BATES

Instant classic. Sis Bates owns the infield with her A2000® SB22 GM, the 11.75" glove pattern with Saddle Tan and Blonde Pro Stock® leather. Featuring purple accents—a nod to Sis' college playing career in Seattle, Washington—the A2000 SB22 GM delivers the perfect amount of style and substance.

INFIELD 11.75"

SKU
WBW1010161175
MSRP
\$299.95

SIS' GLOVE FEATURES

- A2000 SB22 GM
- H-Web
- Saddle Tan/Blonde Pro Stock® Leather
- Game Model of Sis Bates



NEW
GM

AMANDA CHIDESTER

Let your performance say it all. With Saddle Tan Pro Stock® leather, Dark Brown laces and Blonde binding, Amanda Chidester's A2000® AC4 GM first base mitt is designed to corral every throw and hard-hit ball at first base. Purple & Blue gradient Bold Logos empower the A2000 AC4 GM to make a statement on the infield.

1ST BASE 12.5"

SKU
WBW101017125
WBW101020125 [LHT]
MSRP
\$299.95

AMANDA'S GLOVE FEATURES

- A2000 AC4 GM
- Single Post Web
- Saddle Tan Pro Stock® Leather
- Game Model of Amanda Chidester



NEW
GM

AUBREE MUNRO

Aubree Munro designed another crisp design with her latest A2000® AM1 GM catcher's mitt. Featuring the catcher's favorite Blonde Pro Stock® leather with Spin Control® Technology, the A2000 AM1 is designed to enable clean transfers. White SuperSkin™ reduces weight to help catchers perfectly frame every pitch.

CATCHER 34"

SKU
WBW10101834
MSRP
\$299.95

AUBREE'S GLOVE FEATURES

- A2000 AM1 GM
- V Web with Hinge
- Blonde Pro Stock® Leather
- Game Model of Aubree Munro



A2000[®] FP

THE PREMIER GLOVE

Since its introduction in 1957, the A2000[®] has evolved with the game year after year. Durable Pro Stock[®] leather offers a consistent feel and allows for a detailed break-in process. Each fastpitch A2000 is tailored to softball with a larger pocket, a female-specific fit and a drawstring wrist closure to enable easy adjustments. Comfort Pro Fit features a Pro Lux[™] leather palm lining that forms to the player's hand over time, making the A2000 feel like an extension of the body. Flat Finger Binding allows players to comfortably take the field with a finger outside the glove for improved control, and the Bold Logo package is built to stand out. The A2000[®] lineup includes patterns with innovations like SuperSkin[™] and Spin Control[®] Technology, ensuring there is an option for every player.

1.

PRO STOCK[®] LEATHER:

Wilson's iconic Pro Stock[®] leather is preferred for its rugged durability and unmatched feel.

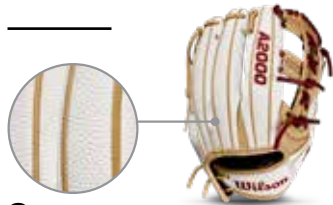

2.

SUPERSKIN[™]:

Twice as strong as traditional Pro Stock[®] leather and only half the weight, giving players the durability they love in a lightweight design.

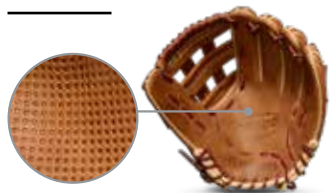

3.

SPIN CONTROL[®] TECHNOLOGY:

A patented surface texture in Wilson's iconic Pro Stock[®] leather generates friction against the ball on contact, giving players more control.



4.

DRAWSTRING CLOSURE:

Make in-game glove adjustments on the fly and ensure a secure fit on the field with the leather drawstring wrist closure. Pull the rawhide laces into place for a perfect fit.





INFIELD 11.75"

SKU
WBW1004371175
MSRP
\$299.95

- A2000 H75
- H-Web
- Grey/White Pro Stock® Leather



INFIELD 11.75"

SKU
WBW100991175
MSRP
\$299.95

- 2023 A2000FP FP75SS
- Cross Web w/ 3X Lace
- Grey SuperSnakeSkin™/Black/Grey Pro Stock® Leather



INFIELD 11.75"

SKU
WBW1010161175
MSRP
\$299.95

- A2000 SB22 GM
- H-Web
- Saddle Tan/Blonde Pro Stock® Leather
- Game Model of Sis Bates



INFIELD 12"

SKU
WBW10099212
MSRP
\$299.95

- 2023 A2000FP H12SS
- H-Web
- White/Blonde Pro Stock® Leather



INFIELD 12"

SKU
WBW10043812
MSRP
\$299.95

- A2000 H12
- H-Web
- Blonde/Saddle Tan Pro Stock® Leather



PITCHER 12"

SKU
WBW10043912
WBW10044012 (LHT)
MSRP
\$299.95

- A2000 P12
- Closed Two-Piece Weave Web
- Blonde/Black Pro Stock® Leather



OUTFIELD 12.5"

SKU
WBW100441125
WBW100442125 (LHT)
MSRP
\$299.95

- A2000 VSS
- Victory Web
- Spin Control® Dimpled Palm
- Grey Superskin™/Grey Pro Stock® Leather



OUTFIELD 12.5"

SKU
WBW100993125
WBW100994125 (LHT)
MSRP
\$299.95

- 2023 A2000FP T125SS
- Pro Laced T-Web
- White SuperSnakeSkin™/Grey/Blonde Pro Stock® Leather



CATCHER 34"

SKU
WBW10101834
MSRP
\$299.95

- A2000 AM1 GM
- V Web with Hinge
- Blonde Pro Stock® Leather
- Game Model of Aubree Munro



1ST BASE 12"

SKU
WBW100219125
WBW100220125
MSRP
\$299.95

- A2000 FP1BSS
- Reinforced Single Post Web
- White Superskin™/Grey Pro Stock® Leather



1ST BASE 12.5"

SKU
WBW101017125
WBW101020125 (LHT)
MSRP
\$299.95

- A2000 AC4 GM
- Single Post Web
- Saddle Tan Pro Stock® Leather
- Game Model of Amanda Chidester



A1000 FP

GAME READY

Grab your glove and get right to work. The A1000® fastpitch glove is game ready from day one thanks to its supple yet sturdy Full Grain leather construction. This series gives rising stars the comfort of a pro caliber glove without the meticulous break in process. These fastpitch designs are curated for softball with a larger pocket, a female-specific fit and a drawstring closure to enable easy adjustments. All components are produced with form-fitting Full Grain leather, resulting in a glove that's easy to control.



DOUBLE PALM CONSTRUCTION (FRONT SIDE):

A thin, perfectly shaped piece of leather placed between the palm liner and outer shell, giving you what matters most: maximum pocket stability.

FULL LEATHER CONSTRUCTION:

Leather shell, laces and pal liner. These ball gloves expertly break in and conform to your hand.

LOW PROFILE HEEL

(FRONT SIDE):

Gives more flexibility, opens up the palm and pocket and makes it more forgiving on bad hops.

DRAWSTRING CLOSURE:

Make in-game glove adjustments on the fly and ensure a secure fit in the field. Pull the long rawhide lace to set your wrist closure into place for the perfect fit.



INFIELD 11.75"

SKU
WBW1001781175
MSRP
\$149.95

- H-Web
- Drawstring Wrist Closure
- White/Blonde/Brick Red Full Grain Optima Leather



INFIELD 12"

SKU
WBW10017912
MSRP
\$149.95

- Dual Post Web
- Drawstring Wrist Closure
- White/Black/Metallic Gold Full Grain Optima Leather



PITCHER 12"

SKU
WBW10018012
WBW10018112
MSRP
\$149.95

- Closed Two-Piece Web
- Drawstring Wrist Closure
- Black/Metallic Gold/White Full Grain Optima Leather



OUTFIELD/PITCHER 12.5"

SKU
WBW100182125
WBW100183125
MSRP
\$149.95

- Closed V-Shape Weave
- Drawstring Wrist Closure
- White/Black/Blonde Full Grain Optima Leather



OUTFIELD 12.5"

SKU
WBW100184125
WBW100185125
MSRP
\$149.95

- Pro Laced T-Web
- Drawstring Wrist Closure
- White/Black/Metallic Gold Full Grain Optima Leather



1ST BASE 12.5"

SKU
WBW10018633
MSRP
\$149.95

- Single Post 3 Bar
- Drawstring Wrist Closure
- White/Blonde/Grey Full Grain Leather



CATCHER 33"

SKU
WBW100430125
WBW100431125
MSRP
\$149.95

- Dual Post Web
- Drawstring Wrist Closure
- Grey/Blonde/White Full Grain Optima Leather



A700®



INFIELD 12"

SKU
WBW10042412
WBW10042812 (LHT)
MSRP
\$89.95

- Dual Post Web
- Drawstring Closure
- Black/White Full Grain Leather



OUTFIELD 12.5"

SKU
WBW100425125
WBW100426125 (LHT)
MSRP
\$89.95

- Closed Victory Web
- Drawstring Closure
- Black/White Full Grain Leather



CATCHER 33"

SKU
WBW10042733
MSRP
\$94.95

- Dual Post Web
- Drawstring Closure
- Black/White Full Grain Leather

SIREN

A new Quick-Fit elastic band has been anchored to the back of the wrist, creating a secure fit for kids with smaller hands.



INFIELD 11.5"

SKU
WBW100419115
MSRP
\$74.95

- H-Web
- Quick-Fit Wrist™
- Black/Blonde/White



INFIELD 12"

SKU
WBW10042012
WBW10042112 (LHT)
MSRP
\$74.95

- Modified X2 WEB
- Quick-Fit Wrist™
- Black/White/Blonde



OUTFIELD 12.5"

SKU
WBW100422125
WBW100423125 (LHT)
MSRP
\$74.95

- V125
- Quick-Fit Wrist™
- Black/Blonde/White

FLASH



INFIELD 11"

SKU
WBW10040611
MSRP
\$49.95

- Closed Victory Web w/ Weave
- Black/Watermelon Tropical Blue



INFIELD 11.5"

SKU
WBW100415115
WBW100416115
MSRP
\$49.95

- Closed Corset Web
- Black/Watermelon Tropical Blue



OUTFIELD 12"

SKU
WBW10041712
WBW10041812
MSRP
\$49.95

- Split Web w/ Pro Lace
- Black/Watermelon Tropical Blue



SLOWPITCH A360®



ALL POSITIONS 13"

SKU
WBW10019213
WBW10019313 (LHT)
MSRP
\$59.95

- Closed w/ V-Laced Web
- Grey/Black
- Carbonlite Shell



ALL POSITIONS 14"

SKU
WBW10019414
WBW10019514 (LHT)
MSRP
\$59.95

- Weave Web
- Grey/Black
- Carbonlite Shell



ALL POSITIONS 15"

SKU
WBW10019615
MSRP
\$59.95

- Dual Post Web w/ Double Bar
- Grey/Black
- Carbonlite Shell

GLOVE CARE



A2000® GLOVE CARE KIT

STOCK NO. WTA6763 TAN

MSRP \$59.95

Same kit used to repair A2000® gloves for big league players • Kit contains: Both black and tan rawhide lace, lacing tool, awl, cutters, threading needles, glove oil, brush and A2000 leather carry bag



WTA6776

PRO STOCK® GLOVE CONDITIONER 12 PC PDQ DISPLAY

STOCK NO. WTA6776PD

MSRP \$11.95 (ea.) \$143.40 (PDQ)

Makes the break-in process easier with premium conditioner that conditions, cleans and restores • Order in multiples of 12



WTA6778

PRO STOCK® MINK OIL PASTE 12 PC PDQ DISPLAY

STOCK NO. WTA6778PD

MSRP \$11.95 (ea.) \$143.40 (PDQ)

Extend the life of your Pro Stock® glove by using premium mink oil to restore and soften leather • Makes leather resistant to water and moisture • Order in multiples of 12

SLOWPITCH GLOVES & GLOVE CARE



DEMARINI® & LOUISVILLE SLUGGER® BASEBALL BATS

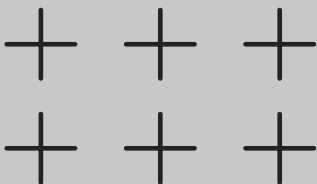

@DEMARINI #DEMARINI #DEMARINATION
@SLUGGERNATION #LOUISVILLELOYAL

2023

BASEBALL BATS



DEMARINI® TOP COLLEGIATE PROGRAMS



BBCOR

BBCOR CERTIFIED .50



ZOA™	2 5/8"	[31"/28] [32"/29] [33"/30] [34"/31]	WTDXZOA-22	-3	MSRP: \$449.95
------	--------	-------------------------------------	------------	----	----------------



CONTINUOUS FIBER COMPOSITE BARREL:
One durable sheet of ultra-strong composite material rolled into itself and crafted into a lighter, more durable barrel with a massive sweet spot and enhanced pop.



CONSTRUCTION:
2-Piece Composite designed to balance speed with power, the Anomaly Connection enables the seamless transfer of energy for better exit velocities.



ANOMALY END CAP:
Built from an all-new blend of durable and lightweight materials, this end cap maintains barrel integrity and improves performance.



PLAYER TYPE:
Built for the well-rounded player seeking the best combination of bat speed, barrel control and power.



CF®	2 5/8"	[30"/27] [31"/28] [32"/29] [33"/30] [34"/31]	WTDXCBC-22	-3	MSRP: \$449.95
-----	--------	--	------------	----	----------------



PARAFLEX® PLUS COMPOSITE BARREL:
Developed to deliver a massive sweet spot and maximum barrel control.



CONSTRUCTION:
2-Piece Composite featuring the 3 Fusion™ Connection and Paraflex™ Plus Composite handle deliver maximum energy transfer to the barrel, not your hands



ReACTION END CAP:
Built with a blend of stronger and lighter materials to increase barrel performance without sacrificing swing speed.



PLAYER TYPE:
Built for gap-to-gap contact hitters seeking greater bat speed and a forgiving feel on contact.



THE GOODS™	2 5/8"	[31"/28] [32"/29] [33"/30] [34"/31]	WTDXGIC-22	-3	MSRP: \$399.95
------------	--------	-------------------------------------	------------	----	----------------



X14 ALLOY BARREL:
A massive alloy barrel designed specifically with elite power hitters in mind.



HALF + HALF:
2-Piece Hybrid with our NEW Direct Connection and Paraflex™ Plus Composite handle tuned for power hitters.



TREMOR END CAP:
Redesigned with stronger materials, this new end cap helps maintain the durability and power of our massive X14 Alloy Barrel.



PLAYER TYPE:
Built for power, our heaviest swinging BBCOR bat allows players to generate insane force.



BBCOR

BBCOR CERTIFIED .50



VOODOO® ONE	2 5/8"	[29"/26]	[30"/27]	[31"/28]	[32"/29]	[33"/30]	[34"/31]	WTDXVOC-22	-3	MSRP: \$349.95
-------------	--------	----------	----------	----------	----------	----------	----------	------------	----	----------------



X14 ALLOY BARREL:
Lightweight performance alloy built for maximum pop and durability, without sacrificing swing speed.



CONSTRUCTION:
1-Piece Alloy designed to reduce vibration in your hands while taking advantage of the increased stiffness.



TRACER END CAP:
Molded with light weight composite materials, this new end cap is designed to enhance bat speed while maintaining powerful barrel performance.



PLAYER TYPE:
Built for the player who wants a light-swinging bat to generate massive swing speeds.



THE GOODS™ ONE PIECE	2 5/8"	[31"/28]	[32"/29]	[33"/30]	[34"/31]	WTDXGOC-22	-3	MSRP: \$349.95
----------------------	--------	----------	----------	----------	----------	------------	----	----------------



X14 ALLOY BARREL:
A massive alloy barrel designed specifically with elite power hitters in mind.



CONSTRUCTION:
1-Piece Alloy that maximizes stiffness for a feel that mirrors wood bats.



TREMOR END CAP:
Redesigned with stronger materials, this new end cap helps maintain the durability and power of our massive X14 Alloy Barrel.



PLAYER TYPE:
Slightly more mass in the barrel for players looking for more power.



WOOD COMPOSITE

BBCOR CERTIFIED .50



NEW



D110 PRO MAPLE™	« BALANCED »	[31"] [32"] [33"] [34"]	WBD2372010	-3	MSRP: \$249.95
-----------------	--------------	-------------------------	------------	----	----------------

M MAPLE

PG APPROVED FOR PERFECT GAME PLAY

NEW



D113 PRO MAPLE™	« ENDOADED »	[31"] [32"] [33"] [34"]	WBD2369010	-3	MSRP: \$249.95
-----------------	--------------	-------------------------	------------	----	----------------

M MAPLE

PG APPROVED FOR PERFECT GAME PLAY

NEW



D243 PRO MAPLE™	« ENDOADED »	[31"] [32"] [33"] [34"]	WBD2370010	-3	MSRP: \$249.95
-----------------	--------------	-------------------------	------------	----	----------------

M MAPLE

A APPROVED FOR SHORT SEASON A

R APPROVED FOR ROOKIE BALL

PG APPROVED FOR PERFECT GAME PLAY

NEW



D271 PRO MAPLE™	« BALANCED »	[31"] [32"] [33"] [34"]	WBD2371010	-3	MSRP: \$249.95
-----------------	--------------	-------------------------	------------	----	----------------

M MAPLE

A APPROVED FOR SHORT SEASON A

R APPROVED FOR ROOKIE BALL

PG APPROVED FOR PERFECT GAME PLAY

FUNGO



FUNGODELIC™ PRO MAPLE™ WOOD COMPOSITE		[35"]	MODEL NO. WTDXFUNDE1835	MSRP: \$109.99
---------------------------------------	--	-------	-------------------------	----------------

M MAPLE

WB WOOD BARREL: For traditional Fungo feel.

END END LOADED FEEL: With weight in the barrel for best ground ball and fly ball hitting.



WOOD FUNGO		[35"]	MODEL NO. WTDXFUNW35	MSRP: \$109.99
------------	--	-------	----------------------	----------------

M MAPLE

H HITTING: Designed for hitting infield and outfield Fungos.



LOUISVILLE SLUGGER® TOP COLLEGIATE PROGRAMS



BBCOR

BBCOR CERTIFIED .50

1 YEAR WARRANTY LIMITED

NEW



META®	2 5/8"	[31"/28]	[32"/29]	[33"/30]	[34"/31]	WBL2639010	-3	MSRP: \$499.95
--------------	--------	----------	----------	----------	----------	------------	----	----------------

BARREL: EKO™ composite—engineered to the pinnacle of performance; light swinging, huge barrel, and the truest sound in the game.

CONSTRUCTION: 3-piece design with updated 3FX™ Connection System provides the feel players want, without transmitting harsh vibrations.

END CAP: Premium GT1™ end cap that improves barrel control and feel.

SWING WEIGHT: Balanced swing weight for the ultimate combination of speed and power.

GRIP: Premium LS PRO Comfort Grip™ for the perfect mix of tack and cushion.

NEW



SELECT PWR™	2 5/8"	[31"/28]	[32"/29]	[33"/30]	[34"/31]	WBL2641010	-3	MSRP: \$399.95
--------------------	--------	----------	----------	----------	----------	------------	----	----------------

BARREL: EXD™ premium alloy barrel for increased barrel and sweet spot size.

CONSTRUCTION: 3-piece design—composite handle with Updated 3FX-PWR™ Connection System that provides unmatched comfort, without sacrificing stiffness for better energy transfer.

END CAP: NEW SPD-Gen2 End Cap designed to maximize barrel performance.

SWING WEIGHT: Power swing weight for increased momentum and maximum distance.

GRIP: Premium LS PRO Comfort Grip™ for the perfect mix of tack and cushion.

NEW



ATLAS	2 5/8"	[29"/26]	[30"/27]	[31"/28]	[32"/29]	[33"/30]	[34"/31]	WBL2643010	-3	MSRP: \$299.95
--------------	--------	----------	----------	----------	----------	----------	----------	------------	----	----------------

BARREL: NEW EVOKE Alloy barrel designed with the latest in kinetic response software delivers a light swing weight with power that punches above its weight.

CONSTRUCTION: 1-piece design with a focus on delivering huge bat speed without sacrificing power.

END CAP: NEW SPD-Gen2 End Cap designed to maximize barrel performance.

SWING WEIGHT: Balanced swing weight for the ultimate combination of speed and power.

GRIP: Premium LS PRO Comfort Grip™ for the perfect mix of tack and cushion.

NEW



VAPOR	2 5/8"	[30"/27]	[31"/28]	[32"/29]	[33"/30]	[34"/31]	WBL2645010	-3	MSRP: \$119.99
--------------	--------	----------	----------	----------	----------	----------	------------	----	----------------

BARREL: Series 7 alloy for maximum durability and performance at an unbelievable value.

CONSTRUCTION: NEW 1-piece designed to reduce swing weight.

END CAP: NEW HUB™ 1-shot end cap design.

GRIP: Standard synthetic leather grip for better bat control.



USSSA/SENIOR LEAGUE



ZOA™	2 3/4"	[28"/18] [29"/19] [30"/20] [31"/21]	WTDXZBZ-22	-10	MSRP: \$399.95
	2 3/4"	[29"/21] [30"/22] [31"/23] [32"/24]	WTDXZBZ-22	-8	
	2 5/8"	[30"/25] [31"/26] [32"/27] [33"/28]	WTDXZB5-22	-5	

CONTINUOUS FIBER COMPOSITE BARREL:
One durable sheet of ultra-strong composite material rolled into itself and crafted into a lighter, more durable barrel with a massive sweet spot and enhanced pop.

CONSTRUCTION:
2-Piece Composite designed to balance speed with power, the Anomaly Connection enables the seamless transfer of energy for better exit velocities.

ANOMALY END CAP:
Built from an all-new blend of durable and lightweight materials, this end cap maintains barrel integrity and improves performance.

PLAYER TYPE:
Built for the elite ball player looking for the most advanced technological features available for USSSA.

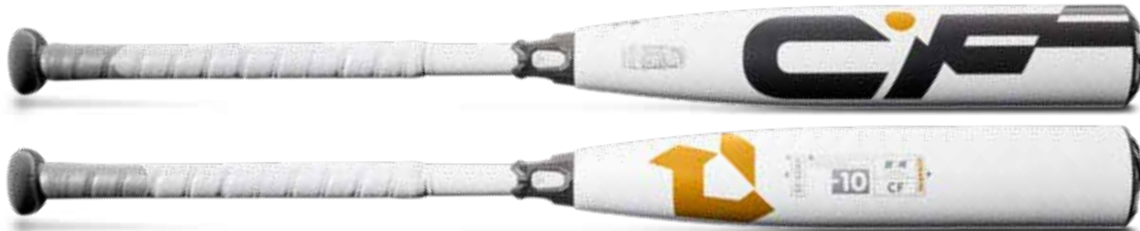

CF®	2 3/4"	[28"/18] [29"/19] [30"/20] [31"/21]	WTDXC8Z-22	-10	MSRP: \$349.95
	2 3/4"	[29"/21] [30"/22] [31"/23] [32"/24]	WTDXC8Z-22	-8	
	2 5/8"	[30"/25] [31"/26] [32"/27] [33"/28]	WTDXC85-22	-5	

PARAFLEX® PLUS COMPOSITE BARREL:
Our legacy composite that has dominated USSSA for years by delivering a massive sweet spot and premium barrel control.

CONSTRUCTION:
2-Piece Composite featuring the 3 Fusion™ Connection and Paraflex™ Plus Composite handle deliver maximum energy transfer to the barrel, not your hands.

ReACTION END CAP:
Built with a blend of stronger and lighter materials to increase barrel performance without sacrificing swing speed.

PLAYER TYPE:
Built for the well-rounded player seeking the best combination of bat speed, barrel control and power.



THE GOODS™ ONE PIECE	2 3/4"	[26"/16] [27"/17] [28"/18] [29"/19] [30"/20] [31"/21]	WTDXG0Z-22	-10	MSRP: \$249.95
	2 3/4"	[29"/21] [30"/22] [31"/23] [32"/24]	WTDXG08-22	-8	

X14 ALLOY BARREL:
Precision engineered with the most consistent walls possible that lead the pack in alloy performance, while maintaining durability and swing speed.

CONSTRUCTION:
1-Piece Alloy designed to reduce vibration in your hands while taking advantage of the increased stiffness.

TRACER END CAP:
Molded with lightweight composite materials, this new end cap is designed to enhance bat speed while maintaining powerful barrel performance.

PLAYER TYPE:
Built for the player who wants a light-swinging bat to generate massive swing speeds.



USSSA/SENIOR LEAGUE



NEW



THE GOODS™	2 3/4"	[28"/18] [29"/19] [30"/20] [31"/21]	WBD2354010 [NEW]	-10	MSRP: \$299.95
	2 5/8"	[30"/25] [31"/26] [32"/27] [33"/28]	WTDXGB5-22	-5	



X14 ALLOY BARREL:
Precision engineered with the most consistent walls possible that lead the pack in alloy performance, while maintaining durability and swing speed.



HALF + HALF:
-10: 2-Piece composite featuring the Type-V Connection and Paraflex™ Plus Composite handle deliver improved bat speed and premium feel on contact.



TRACER END CAP:
-10: Molded with lightweight composite materials, this new end cap is designed to enhance bat speed while maintaining powerful barrel performance.



PLAYER TYPE:
-10: Built for players that want premium bat speed, barrel control and power with a hybrid bat feel.



HALF + HALF:
-5: 2-Piece Hybrid featuring Direct Connection and Paraflex™ Plus Composite handle deliver greater power for players approaching BBCOR play.



TREMOR END CAP:
-5: Redesigned with stronger materials, this new end cap helps maintain the durability and power of our massive X14 Alloy Barrel.



PLAYER TYPE:
-5: Built for the player searching for increased power and the feel of a hybrid bat as they approach BBCOR play.

NEW



ZOA™ JBB	2 3/4"	[26"/15] [27"/16] [28"/17]	WBD2353010	-11	MSRP: \$299.95
----------	--------	----------------------------	------------	-----	----------------



CONTINUOUS FIBER COMPOSITE BARREL:
One durable sheet of ultra-strong composite material rolled into itself and crafted into a lighter, more durable barrel with a massive sweet spot and enhanced pop.



CONSTRUCTION:
2-Piece Composite designed to balance speed with power, the Anomaly Connection enables the seamless transfer of energy for better exit velocities.



ANOMALY END CAP:
Built from an all-new blend of durable and lightweight materials, this end cap maintains barrel integrity and improves performance.



PLAYER TYPE:
Engineered for younger players looking for a light-swinging performance bat.



UPRISING® JBB	2 3/4"	[26"/16] [27"/17] [28"/18] [29"/19] [30"/20]	WBD2234010	-10	MSRP: \$119.99
---------------	--------	--	------------	-----	----------------



DX1™ ALLOY BARREL:
High strength alloy built for performance and durability.



CONSTRUCTION:
1-Piece Alloy designed for increased bat control



ION D END CAP:
Built to provide a lighter swing weight



PLAYER TYPE:
Engineered for younger players looking for a light-swinging performance bat.



USSSA/SENIOR LEAGUE



NEW



META®	2 3/4"	[27"/17] [28"/18] [29"/19] [30"/20] [31"/21]	WBL2647010	-10	MSRP: \$399.95
	2 3/4"	[29"/21] [30"/22] [31"/23] [32"/24]	WBL2648010	-8	
	2 5/8"	[30"/25] [31"/26] [32"/27]	WBL2649010	-5	

BARREL:
NEW EKO™ Composite Gapped Wall—Designed to provide a larger sweet spot, unique sound, and unbelievable performance from a light swinging platform.

CONSTRUCTION:
3-piece design featuring an updated VCX2™ Vibration Control Connection System—This patented connection system provides unmatched comfort while delivering the feel that players want.

END CAP:
Premium GT1™ end cap that improves barrel control and feel.

SWING WEIGHT:
Balanced swing weight for the ultimate combination of speed and power.

GRIP:
Premium LS PRO Comfort Grip™ for the perfect mix of tack and cushion.

NEW



SELECT PWR™	2 3/4"	[27"/17] [28"/18] [29"/19] [30"/20] [31"/21]	WBL2651010	-10	MSRP: \$299.95
	2 3/4"	[29"/21] [30"/22] [31"/23] [32"/24]	WBL2652010	-8	
	2 5/8"	[30"/25] [31"/26] [32"/27]	WBL2653010	-5	

BARREL:
EXD™ premium alloy barrel for increased barrel and sweet spot size.

CONSTRUCTION:
3-piece design featuring an Updated VCX2™ Vibration Control Connection System—This patented connection system provides unmatched comfort while delivering the feel that players want.

END CAP:
NEW SPD-Gen2 End Cap designed to maximize barrel performance while delivering increased barrel control.

SWING WEIGHT:
Balanced swing weight for the ultimate combination of speed and power.

GRIP:
Premium LS PRO Comfort Grip™ for the perfect mix of tack and cushion.

NEW



META® ONE	2 3/4"	[27"/15] [28"/16] [29"/17] [30"/18] [31"/19]	WBL2650010	-12	MSRP: \$249.95
------------------	--------	--	------------	-----	-----------------------

BARREL:
EKO™ composite—engineered to the pinnacle of performance; light swinging, large barrel profile and optimized sweet spot.

CONSTRUCTION:
1-piece construction for stiffer feel on contact and more energy transfer.

END CAP:
Premium GT1™ end cap that improves barrel control and feel.

SWING WEIGHT:
Ultra balanced swing weight— for one of our easiest to swing SL models.

GRIP:
Premium LS PRO Comfort Grip™ for the perfect mix of tack and cushion.



USSSA/SENIOR LEAGUE



NEW



ATLAS	2 3/4"	[26"/16] [27"/17] [28"/18] [29"/19] [30"/20] [31"/21]	WBL2654010	-10	MSRP: \$249.95
	2 3/4"	[29"/21] [30"/22] [31"/23] [32"/24]	WBL2655010	-8	
	2 5/8"	[30"/25] [31"/26] [32"/27]	WBL2656010	-5	

BARREL:
NEW EVOKE Alloy barrel designed with the latest in kinetic response software delivers a light swing weight with power that punches above its weight.

CONSTRUCTION:
1-piece construction designed for maximum speed through the zone.

END CAP:
(-10 and -8) NEW Dual Pivot End Cap allows for barrel walls to deflect for better performance, without sacrificing strength.

(-5) NEW SPD-Gen2 End Cap designed to maximize barrel performance while delivering increased barrel control.

SWING WEIGHT:
Balanced swing weight for increased swing speed.

GRIP:
Premium LS PRO Comfort Grip™ for the perfect mix of tack and cushion.

NEW



ATLAS JBB	2 3/4"	[25"/15] [26"/16] [27"/17] [28"/18]	WBL2647010	-10	MSRP: \$119.99
-----------	--------	-------------------------------------	------------	-----	----------------

BARREL:
SL Hyper™ superlight alloy with thinner wall design for maximum pop.

CONSTRUCTION:
1-piece construction for stiffer feel on contact and more energy transfer.

END CAP:
6-Star™ premium end cap design for power and performance.

SWING WEIGHT:
Balanced swing weight that is easy to swing through the zone.

GRIP:
Standard Baseball Grip with improved cushion.



USA BASEBALL



CF®	2 5/8"	[29"/19] [30"/20] [31"/21] [32"/22]	WTDXUFX-22	-10	MSRP: \$349.95
-----	--------	-------------------------------------	------------	-----	----------------

- PARAFLEX® PLUS COMPOSITE BARREL:** Developed to deliver a massive sweet spot and maximum barrel control, this is the most consistently high-performing barrel in the game.
- CONSTRUCTION:** 2-Piece Composite featuring the 3 Fusion™ Connection and Paraflex™ Plus Composite handle deliver maximum energy transfer to the barrel, not your hands.
- ReACTION END CAP:** Built with a blend of stronger and lighter materials to increase barrel performance without sacrificing swing speed.
- PLAYER TYPE:** Built for the well-rounded player seeking the best combination of bat speed, barrel control and power.



THE GOODS™	2 5/8"	[28"/18] [29"/19] [30"/20] [31"/21] [32"/22]	WBD2359010	-10	MSRP: \$249.95
------------	--------	--	------------	-----	----------------

- X14 ALLOY BARREL:** Precision engineered with the most consistent walls possible that lead the pack in alloy performance, while maintaining durability and swing speed.
- HALF + HALF:** 2-Piece composite featuring the Type-V Connection and Paraflex™ Plus Composite handle deliver maximum energy transfer to the barrel, not your hands.
- TRACER END CAP:** Molded with lightweight composite materials, this new end cap is designed to enhance bat speed while maintaining powerful barrel performance.
- PLAYER TYPE:** Built for players that want premium bat speed, barrel control and power with a hybrid bat feel.



USA V00000 ONE PIECE	2 5/8"	[26"/15] [27"/16] [28"/17] [29"/18] [30"/19] [31"/20]	WBD2360010	-11	MSRP: \$199.95
	2 5/8"	[30"/25] [31"/26] [32"/27]	WBD2361010	-5	

- X14 ALLOY BARREL:** Precision engineered with the most consistent walls possible that lead the pack in alloy performance, while maintaining durability and swing speed.
- CONSTRUCTION:** 1-Piece Alloy designed to reduce vibration in your hands while taking advantage of the increased stiffness.
- TRACER END CAP:** Molded with lightweight composite materials, this new end cap is designed to enhance bat speed while maintaining powerful barrel performance.
- PLAYER TYPE:** Built for the player who wants to generate massive swing speeds with a lightweight performance bat.



UPRISING®	2 1/2"	[26"/15] [27"/16] [28"/17] [29"/18] [30"/19] [31"/20] [32"/21]	WBD2235010	-11	MSRP: \$109.99
-----------	--------	--	------------	-----	----------------

- DX1™ ALLOY BARREL:** High strength alloy built for performance and durability.
- CONSTRUCTION:** 1-Piece Alloy designed for increased bat control.
- ION D END CAP:** Built to provide a lighter swing weight.
- PLAYER TYPE:** Engineered for younger players looking to prioritize swing speed.



USA BASEBALL



NEW



META®	2 5/8"	[28"/16]	[29"/17]	[30"/18]	[31"/19]	WBL2659010	-12	MSRP: \$399.95
--------------	---------------	----------	----------	----------	----------	------------	-----	-----------------------

BARREL:
EKO™ composite—engineered to the pinnacle of performance; light swinging, large barrel profile and optimized sweet spot.

CONSTRUCTION:
3-piece design featuring an updated VCX2™ Vibration Control Connection System—This patented connection system provides unmatched comfort while delivering the feel that players want.

END CAP:
NEW GT1™ end cap that improves barrel control and feel.

SWING WEIGHT:
Balanced swing weight for the ultimate combination of speed and power.

GRIP:
Premium LS PRO Comfort Grip™ for the perfect mix of tack and cushion.

NEW



SELECT PWR™	2 5/8"	[29"/19]	[30"/20]	[31"/21]	[32"/22]	WBL2660010	-10	MSRP: \$299.95
	2 5/8"	[29"/21]	[30"/22]	[31"/23]	[32"/24]	WBL2661010	-8	
	2 5/8"	[30"/25]	[31"/26]	[32"/27]	WBL2662010	-5		

BARREL:
EXD™ premium alloy barrel for increased barrel and sweet spot size.

CONSTRUCTION:
3-piece design featuring an updated VCX2™ Vibration Control Connection System—This patented connection system provides unmatched comfort while delivering the feel that players want.

END CAP:
NEW SPD-Gen2 End Cap designed to maximize barrel performance while delivering increased barrel control.

SWING WEIGHT:
Balanced swing weight for the ultimate combination of speed and power.

GRIP:
Premium LS PRO Comfort Grip™ for the perfect mix of tack and cushion.



USA BASEBALL



NEW



ATLAS	2 5/8"	[26"/14]	[27"/15]	[28"/16]	[29"/17]	[30"/18]	[31"/19]	WBL2663010	-12	MSRP: \$249.95
--------------	---------------	----------	----------	----------	----------	----------	----------	------------	-----	----------------

BARREL: NEW EVOKE Alloy barrel designed with the latest in kinetic response software delivers a light swing weight with power that punches above its weight.	CONSTRUCTION: 1-piece construction designed for maximum speed through the zone.	END CAP: NEW SPD-Gen2 End Cap designed to maximize barrel performance while delivering increased barrel control.	SWING WEIGHT: Balanced swing weight for increased swing speed.	GRIP: Premium LS PRO Comfort Grip™ for the perfect mix of tack and cushion.
--	---	--	--	---

NEW



OMAHA®	2 5/8"	[26"/15]	[27"/16]	[28"/17]	[29"/18]	[30"/19]	[31"/20]	[32"/21]	WBL2664010	-11	MSRP: \$119.95
---------------	---------------	----------	----------	----------	----------	----------	----------	----------	------------	-----	----------------

BARREL: ST7 alloy for more power on contact.	CONSTRUCTION: Updated 1-piece construction with a lighter -11 drop weight drop for better bat speed.	END CAP: NEW HUB™ 1-shot end cap design .	SWING WEIGHT: Balanced swing weight that feels great through the zone.	GRIP: Standard synthetic leather grip for better bat control.
--	--	---	--	---

NEW



VAPOR	2 5/8"	[26"/16]	[27"/17]	[28"/18]	[29"/19]	[30"/20]	[31"/21]	WBL2665010	-10	MSRP: \$69.99
--------------	---------------	----------	----------	----------	----------	----------	----------	------------	-----	---------------

BARREL: Series 7 Premium alloy for performance at an unbelievable value.	CONSTRUCTION: Updated 1-piece design for maximum stiffness on contact in a lighter swinging profile.	END CAP: NEW HUB™ 1-shot end cap design .	GRIP: Standard synthetic leather grip for better bat control.
--	--	---	---



TEEBALL



NEW



CF® TEEBALL	2 5/8"	[25"/12] [26"/13]	WBD2335010	-13	MSRP: \$79.95
-------------	--------	-------------------	------------	-----	---------------



TP COMPOSITE BARREL:
Tailored for use with approved T-Balls.



HALF + HALF:
1-Piece construction designed for maximum speed through the zone.



ION D END CAP:
Provides a lighter swing weight.



PLAYER TYPE:
Built for Tee Ball players looking for a very lightweight bat.



TEEBALL



NEW



META® TEEBALL	2 5/8"	[25"/12] [26"/13]	WBL2667010	-13	MSRP: \$79.95
---------------	--------	-------------------	------------	-----	---------------

BARREL:
100% composite – for use with approved Teeballs.

CONSTRUCTION:
1-Piece construction designed for maximum speed through the zone.

END CAP:
Molded design end to maximize barrel profile and increase swing speed.

GRIP:
Premium LS PRO Comfort Grip™ for the perfect mix of tack and cushion.

NEW



ATLAS TEEBALL	2 1/4"	[24"/11.5] [25"/12.5] [26"/13.5]	WBL2666010	-12.5	MSRP: \$39.99
---------------	--------	----------------------------------	------------	-------	---------------

BARREL:
100% alloy – for use with approved Teeballs.

CONSTRUCTION:
1-Piece design for an easy to swing light design.

END CAP:
Durable HUB™ 1-shot end cap design.

GRIP:
Standard synthetic leather grip for better bat control.

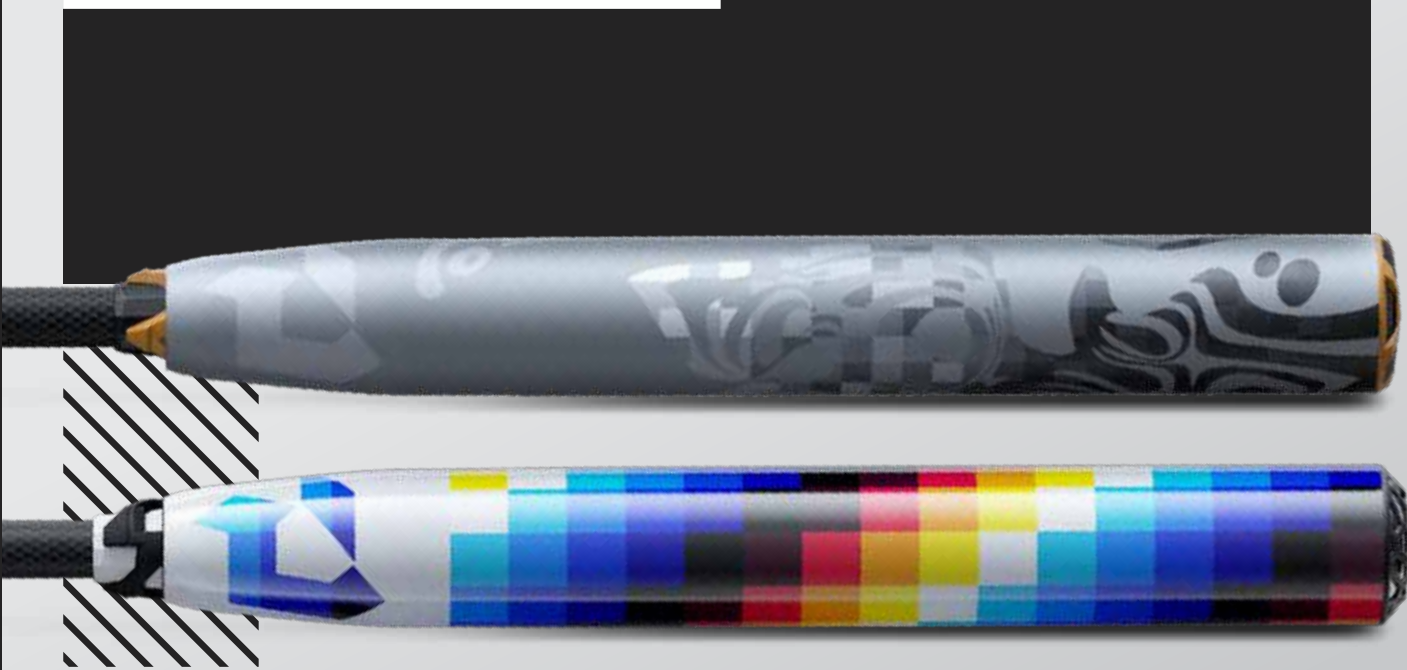

DEMARINI® & LOUISVILLE SLUGGER® FASTPITCH BATS



FASTPITCH BATS

2023

@DEMARINIFP
@SLUGGERFP

#DEMARINIFP #SHESWINGSSLUGGER

#DEMARININATION

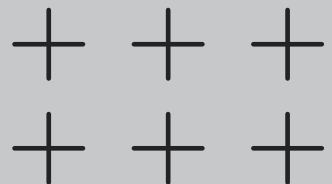



DEMARINI® TOP COLLEGIATE PROGRAMS



FASTPITCH



NEW



WHISPER	2 1/4"	[30"/20] [31"/21] [32"/22] [33"/23] [34"/24]	WBD2364010	-10	MSRP: \$449.95
		[32"/23] [33"/24] [34"/25]	WBD2417010	-9	
		[33"/25] [34"/26]	WBD2439010	-8	



AMPLIFIED GAPPED WALL CONTINUOUS FIBER BARREL:
All-new inner and outer walls with a larger gap increases performance and creates a brighter sound.



CONSTRUCTION:
2-Piece Composite designed to balance speed with power, the Anomaly Connection enables the seamless transfer of energy for better exit velocities.



ANOMALY END CAP:
Built from an all-new blend of durable and lightweight materials, this end cap maintains barrel integrity and improves performance.



PLAYER TYPE:
Hitters focused on maximizing exit velocity and driving the ball for extra bases.

NEW



PRISM+™	2 1/4"	[28"/17] [29"/18] [30"/19] [31"/20] [32"/21] [33"/22]	WBD2362010	-11	MSRP: \$399.95
		[31"/21] [32"/22] [33"/23] [34"/24]	WBD2363010	-10	



GAPPED WALL BARREL WITH CONTINUOUS FIBER COMPOSITE:
Multiple composite walls work in tandem to deliver the ultimate lightweight performance barrel in Fastpitch.



CONSTRUCTION:
2-Piece composite featuring the Type-V™ Connection and Paraflex™ Plus Composite handle deliver maximum energy transfer to the barrel, not your hands.



REFRACT END CAP:
Helps players generate extreme bat speed and take advantage of the elite performance of the Prism.



PLAYER TYPE:
Built for the well-rounded player looking for the best combination of swing speed and feel on the market.

NEW



CF®	2 1/4"	[28"/17] [29"/18] [30"/19] [31"/20] [32"/21] [33"/22]	WBD2365010	-11	MSRP: \$399.95
		[30"/20] [31"/21] [32"/22] [33"/23] [34"/24]	WBD2366010	-10	
		[32"/23] [33"/24] [34"/25]	WBD2367010	-9	
		[33"/25] [34"/26]	WBD2368010	-8	



PARAFLEX® PLUS COMPOSITE BARREL:
Developed to deliver a massive sweet spot and maximum barrel control, this is the most consistently high-performing barrel in the game.



CONSTRUCTION:
2-Piece composite featuring the Type-V™ Connection and Paraflex™ Plus Composite handle deliver maximum energy transfer to the barrel, not your hands.



TRACER END CAP:
Molded with lightweight composite materials, this end cap is designed to enhance bat speed while maintaining powerful barrel performance.



PLAYER TYPE:
Perfect for the elite player looking to generate extreme swing speed without giving up power.



FASTPITCH



SPRYTE	2 1/4"	[29"/17] [30"/18] [31"/19] [32"/20] [33"/21]	WTDXSPF-22	-12	MSRP: \$229.95
---------------	---------------	--	------------	-----	----------------

- PARADOX™ COMPOSITE BARREL:** Designed to perform with a softer, hotter, and more responsive feel for younger players.
- CONSTRUCTION:** 100% Composite 2-Piece Design that utilizes our D-Lite™ Handle to reduce vibration for a smooth feel on every swing.
- BIG D™ END CAP:** Helps to absorb vibration so hitters can swing with confidence.
- PLAYER TYPE:** Built for the developing player who wants a bat that will help generate more bat speed.



ZENITH	2 1/4"	[28"/15] [29"/16] [30"/17] [31"/18] [32"/19]	WTXDPPF-22	-13	MSRP: \$129.99
---------------	---------------	--	------------	-----	----------------

- DX1™ ALLOY BARREL:** High strength alloy built for performance and durability.
- HALF + HALF:** Featuring the TP handle that helps hitters swing for the fences, without worrying about contact vibration.
- BIG D™ END CAP:** Helps to absorb vibration so hitters can swing with confidence.
- PLAYER TYPE:** Engineered for younger players looking for a light-swinging performance bat.



UPRISING®	2 1/4"	[28"/16] [29"/17] [30"/18] [31"/19] [32"/20]	WBD2236010	-13	MSRP: \$79.99
------------------	---------------	--	------------	-----	---------------

- DX1™ ALLOY BARREL:** High strength alloy built for performance and durability.
- CONSTRUCTION:** 1-Piece design for a responsive feel.
- BIG D™ END CAP:** Helps to absorb vibration so hitters can swing with confidence.
- PLAYER TYPE:** Engineered for younger players looking for a light-swinging performance bat.



LOUISVILLE SLUGGER® TOP COLLEGIATE PROGRAMS



FASTPITCH



META®	2 1/4"	[29"/18] [30"/19] [31"/20] [32"/21] [33"/22]	WBL2622010	-11	MSRP: \$449.95
		[29"/19] [30"/20] [31"/21] [32"/22] [33"/23] [34"/24]	WBL2492010	-10	
		[32"/23] [33"/24] [34"/25]	WBL2495010	-9	
		[33"/25] [34"/26]	WBL2496010	-8	

BARREL:
Mash Composite barrel engineered to be the highest performing fastpitch barrel in the game with an unmistakable sound.

CONSTRUCTION:
2-Piece design featuring our VTX Connection designed to work with our MASH composite barrel to deliver better energy transfer and improved feel.

END CAP:
F2X End Cap - Designed to work specifically with the Meta's gapped wall platform.

SWING WEIGHT:
Balanced swing weight for extreme control and maximum swing speed.

PREMIUM LS® PRO COMFORT GRIP™:
With increased tack and cushion for better feel and more control.



LXT™	2 1/4"	[28"/17] [29"/18] [30"/19] [31"/20] [32"/21] [33"/22]	WBL2542010	-11	MSRP: \$399.95
		[30"/20] [31"/21] [32"/22] [33"/23] [34"/24]	WBL2543010	-10	
		[32"/23] [33"/24] [34"/25]	WBL2544010	-9	
		[33"/25] [34"/26]	WBL2545010	-8	

BARREL:
Speed Composite Design with patented single disk—PBF Technology™ for maximum pop, a huge sweet spot, and unbelievable sound on contact.

CONSTRUCTION:
3-Piece design featuring updated VCX2™ Vibration Control Connection System—a patented elastomeric connection that allows independent movement between the barrel and the handle to control vibration and provide unmatched feel on contact.

END CAP:
COPA™ performance end cap works with the barrel to maximize the sweet spot.

SWING WEIGHT:
Balanced swing weight for extreme control and maximum swing speed.

PREMIUM LS® PRO COMFORT GRIP™:
For the perfect mix of tack and cushion.



FASTPITCH



NEXUS	2 1/4"	[28"/16] [29"/17] [30"/18] [31"/19] [32"/20] [33"/21]	WBL2459010	-12	MSRP: \$229.95
--------------	---------------	---	------------	-----	----------------

BARREL: 100% Performance Composite Design that allows for a large sweet spot and control at the plate.	CONSTRUCTION: 2-Piece design featuring the XCT Connection to control vibration and deliver great feel on contact.	END CAP: Ultra lightweight X-Cap™ design for improved speed and control at the plate.	SWING WEIGHT: Balanced swing weight that is perfect for all player types.	STANDARD FASTPITCH GRIP With improved cushion.
--	---	---	---	--



PROVEN™	2 1/4"	[28"/15] [29"/16] [30"/17] [31"/18] [32"/19] [33"/20]	WBL2550010	-13	MSRP: \$129.99
----------------	---------------	---	------------	-----	----------------

BARREL: Full composite design with an engineered sweet spot for improved pop and feel.	CONSTRUCTION: 1-Piece design for a solid feel on contact.	SWING WEIGHT: Ultra balanced—light & easy to swing for increased control and bat speed.
--	---	---



QUEST™	2 1/4"	[27"/15] [28"/16] [29"/17] [30"/18] [31"/19] [32"/20] [33"/21]	WBL2551010	-12	MSRP: \$64.99
---------------	---------------	--	------------	-----	---------------

BARREL: Full performance alloy for increased durability and swing speed.	CONSTRUCTION: 1-Piece design for a solid feel on contact.	SWING WEIGHT: Ultra balanced—light & easy to swing for increased control and bat speed.
--	---	---



DIVA™	2 1/4"	[27"/15.5] [28"/16.5] [29"/17.5] [30"/18.5] [31"/19.5]	WBL2552010	-11.5	MSRP: \$34.99
--------------	---------------	--	------------	-------	---------------

BARREL: Full alloy construction engineered specifically for the youth player.	CONSTRUCTION: 1-Piece design that delivers performance at a great value.	SWING WEIGHT: Ultra balanced—light & easy to swing for younger players.
---	--	---



DEMARINI[®] SLOWPITCH BATS

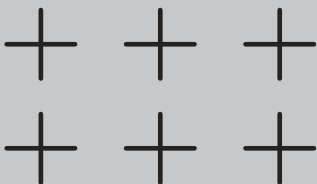



ALL ASSOCIATION



STEEL	2 1/4"	[34"/26] [34"/27] [34"/28]	WTDXSTL-22	MSRP: \$249.95
-------	--------	----------------------------	------------	----------------



12" CARBURIZED SEAMLESS DRAWN STEEL BARREL:
For increased performance, strength and durability. Designed Specifically for DeMarini®



ZNX ALLOY HANDLE:
2-Piece design with less flex, increased barrel deflection and increased overall performance.



ULTIMATE WEAPON™	2 1/4"	[34"/25] [34"/26] [34"/27] [34"/28]	WTDXUWE-22	MSRP: \$169.99
------------------	--------	-------------------------------------	------------	----------------



12" SC4™ ALLOY BARREL:
Built for a solid feel on contact.



CONSTRUCTION:
1-Piece Alloy construction.



WINDY CITY™	2 1/4"	[34"/32] [34"/34] [34"/36] [34"/38]	WTDXWCS-22	MSRP: \$169.99
-------------	--------	-------------------------------------	------------	----------------



12.5" SC4™ ALLOY BARREL:
Built specifically for mushball to create a solid feel on contact.



CONSTRUCTION:
Single wall, 1-Piece construction.



CORNDOG™ WOOD COMPOSITE	2 1/4"	[34"/27] [34"/28]	WBD2237010	MSRP: \$199.95
-------------------------	--------	-------------------	------------	----------------



PRO MAPLE™ BARREL



CONSTRUCTION:
Continuous taper design with Paraflex™ Composite Handle.



WARRANTY:
Corndog™ Wood Composite includes a 90 day warranty.



UPRISING®	2 1/4"	[34"/26] [34"/27] [34"/28]	WBD2238010	MSRP: \$109.99
-----------	--------	----------------------------	------------	----------------



DX1™ ALLOY BARREL:
High strength alloy built for performance.



CONSTRUCTION:
Single wall construction.



Ronald Acuña Jr.
READY FOR PRIMETIME



POWERIZED™

MLB MAPLE RA13
Ronald Acuña Jr.
LOUISVILLE SLUGGER

RONALD ACUÑA JR.

MLB PRIME SIGNATURE SERIES RA13

WOOD BATS

THE DIFFERENCE IS IN THE DETAILS



KNOB MEDALLION

Easy-to-read medallions have been embedded in the knob and indicate the MLB® Prime® grade of wood, species and length, while the bat name is engraved in the surrounding area.

EXOPRO FINISH

The MLB® Prime® lineup features the revolutionary EXOPRO finish that's twice as hard as the previous EXOARMOR®. This innovation in wood bat technology gives you a finish you can feel in an incredibly durable top coat that not only drastically increases surface hardness, but gives you a mirror-like finish in high-gloss models.

SEAMLESS DECALS

Louisville Slugger's exclusive Seamless Decals are applied directly under the top coat, giving MLB® Prime® bats a pristine look. All MLB Prime models feature branding that blends into the bat almost as intricately as the grain of the wood.

CRAFTSMAN-STYLE CUP

Our completely re-engineered Craftsman-Style Cup features a thicker width edge along the end of the barrel, lending added strength and durability to the end of the bat to help reduce chipping and cracking.

30-DAY LIMITED WARRANTY

All MLB® Prime® bats come with a 30-day limited warranty. Restrictions apply. Visit Slugger.com for complete details.

WOOD SPECIES

Louisville Slugger is dedicated to crafting wood bats perfect for each player. We offer several wood species, headlined by Maple and Birch. So no matter how you like your lumber, the team at Louisville Slugger has you covered.



MAPLE

The dominant wood species in Major League Baseball, Maple bats are known for their surface hardness, stiffer feel and unmatched sound.



BIRCH

One of the newer, but fastest growing wood species in Major League Baseball, Birch bats feature a surface hardness close to that of maple but increased flexibility.

SWING WEIGHT SCALE

Everyone talks about the length and weight of their baseball bat. But swing weight might be one of the most impactful ways to classify bats. Swing weight is a determination of how a bat's weight is distributed along its length. More weight toward the end of the barrel means you're swinging an end-loaded bat. These models create more momentum in a player's swing and generate more power and distance. Evenly distributed weight in balanced bats allow for a potentially greater swing speed for many hitters – perfect for players who focus on bat control and increased contact.





MLB® PRIME® SIGNATURE SERIES BATS



CY22—CHRISTIAN YELICH			WBL2435010	MSRP: \$169.95
		SWING WEIGHT: 4 [SLIGHTLY END LOADED]	FINISH: BLACK	IN: [31"] [32"] [33"] [34"]
WOOD: MLB® MAPLE	TURNING MODEL: CY22	TOP COAT: EXOPRO—PRO HARDCOAT	INK DOT: YES	BONE RUBBED: YES
			BONE RUBBED: YES	CUPPED: YES



RA13—RONALD ACUÑA JR.			WBL2436010	MSRP: \$169.95
		SWING WEIGHT: 4 [SLIGHTLY END LOADED]	FINISH: HARDLINE (BLACK TAPE) BLACK TO NATURAL	IN: [31"] [32"] [33"] [33.5"] [34"]
WOOD: MLB® MAPLE	TURNING MODEL: RA13	TOP COAT: EXOPRO—PRO HARDCOAT	INK DOT: YES	BONE RUBBED: YES
			BONE RUBBED: YES	CUPPED: YES



CB35—CODY BELLINGER			WBL2437010	MSRP: \$169.95
		SWING WEIGHT: 4 [SLIGHTLY END LOADED]	FINISH: NATURAL	IN: [31"] [32"] [33"] [33.5"] [34"]
WOOD: MLB® MAPLE	TURNING MODEL: CB35	TOP COAT: EXOPRO—PRO HARDCOAT	INK DOT: YES	BONE RUBBED: YES
			BONE RUBBED: YES	CUPPED: NO



EJ74—ELOY JIMENEZ			WBL2438010	MSRP: \$169.95
		SWING WEIGHT: 4 [SLIGHTLY END LOADED]	FINISH: HARDLINE (SILVER TAPE) NATURAL TO BLACK	IN: [31"] [32"] [33"] [34"]
WOOD: MLB® MAPLE	TURNING MODEL: EJ74	TOP COAT: EXOPRO—PRO HARDCOAT	INK DOT: YES	BONE RUBBED: YES
			BONE RUBBED: YES	CUPPED: YES



MLB® PRIME® SIGNATURE SERIES BATS



KS12 – KYLE SCHWARBER			WBL2679010	MSRP: \$169.95
		SWING WEIGHT: 4 [SLIGHTLY END LOADED]	FINISH: HARDLINE [BLACK TAPE] BLACK TO NATURAL	IN: [31"] [32"] [33"] [34"]
WOOD: MLB® MAPLE	TURNING MODEL: KS12	TOP COAT: EXOPRO–PRO HARDCOAT	INK DOT: YES	BONE RUBBED: YES
			BONE RUBBED: YES	CUPPED: YES



VG27 – VLADIMIR GUERRERO JR.			WBL2678010	MSRP: \$169.95
		SWING WEIGHT: 4 [SLIGHTLY END LOADED]	FINISH: HARDLINE [BLACK TAPE] BLACK TO WINE	IN: [31"] [32"] [33"] [34"]
WOOD: MLB® BIRCH	TURNING MODEL: VG27	TOP COAT: EXOPRO–PRO HARDCOAT	INK DOT: YES	BONE RUBBED: YES
			BONE RUBBED: YES	CUPPED: NO

MLB® PRIME®



DJ2			WBL2683010	MSRP: \$159.95
		SWING WEIGHT: 3 [SLIGHTLY BALANCED]	FINISH: BLACK	IN: [31"] [32"] [33"] [34"]
WOOD: MLB® MAPLE	TURNING MODEL: DJ2	TOP COAT: EXOPRO–PRO HARDCOAT	INK DOT: YES	BONE RUBBED: YES
			BONE RUBBED: YES	CUPPED: YES



C271 MAPLE			WBL2680010	MSRP: \$159.95
		SWING WEIGHT: 1 [MOST BALANCED]	FINISH: BLACK	IN: [31"] [32"] [33"] [34"]
WOOD: MLB® MAPLE	TURNING MODEL: C271	TOP COAT: EXOPRO–PRO HARDCOAT	INK DOT: YES	BONE RUBBED: YES
			BONE RUBBED: YES	CUPPED: YES



MLB® PRIME®

NEW



C271 BIRCH			WBL2684010	MSRP: \$159.95
		SWING WEIGHT: 1 [MOST BALANCED]	FINISH: FADE—BLACK TO GREY	IN: [31"] [32"] [33"] [34"]
WOOD: MLB® BIRCH	TURNING MODEL: C271	TOP COAT: EXOPRO—PRO HARDCOAT	INK DOT: YES	BONE RUBBED: YES
			BONE RUBBED: YES	CUPPED: YES

NEW



U47			WBL2682010	MSRP: \$159.95
		SWING WEIGHT: 3 [SLIGHTLY BALANCED]	FINISH: CRAWFORD BLEND	IN: [31"] [32"] [33"] [34"]
WOOD: MLB® MAPLE	TURNING MODEL: U47	TOP COAT: EXOPRO—PRO HARDCOAT	INK DOT: YES	BONE RUBBED: YES
			BONE RUBBED: YES	CUPPED: YES

PLAYERS CUT

NEW



PLAYERS CUT—BALANCED			WBL2600010	MSRP: \$109.99
		SWING WEIGHT: 1 [MOST BALANCED]	FINISH: MATTE GREY STAIN	IN: [31"] [32"] [33"]
WOOD: MIX	TURNING MODEL: MIX	TOP COAT: EXOPRO—PRO HARDCOAT	BONE RUBBED: YES	CUPPED: YES

NEW



PLAYERS CUT—END LOAD			WBL2601010	MSRP: \$109.99
		SWING WEIGHT: 4 [SLIGHTLY END LOADED]	FINISH: MATTE HICKORY	IN: [31"] [32"] [33"]
WOOD: MIX	TURNING MODEL: MIX	TOP COAT: EXOPRO—PRO HARDCOAT	BONE RUBBED: YES	CUPPED: YES



SELECT CUT

NEW



M9 C271		WBL2685010	MSRP: \$109.99
		SWING WEIGHT: 1 [MOST BALANCED]	FINISH: NATURAL GLOSS
WOOD: MAPLE	TURNING MODEL: C271	TOP COAT: EXOPRO-PRO HARDCOAT	IN: [31"] [32"] [33"] [34"]
			CUPPED: YES

NEW



M9 C243		WBL2686010	MSRP: \$109.99
		SWING WEIGHT: 4 [SLIGHTLY END LOADED]	FINISH: BLACK GLOSS
WOOD: MAPLE	TURNING MODEL: C243	TOP COAT: EXOPRO-PRO HARDCOAT	IN: [32"] [33"] [34"]
			CUPPED: YES

NEW



SELECT B9 MIX		WBL2687010	MSRP: \$109.99
		SWING WEIGHT: MIXED	FINISH: BLACK GLOSS
WOOD: BIRCH	TURNING MODEL: MIX	TOP COAT: EXOPRO-PRO HARDCOAT	IN: [32"] [33"] [34"]
			CUPPED: YES

LEGACY

NEW



LEGACY LTE MIX		WBL2688010	MSRP: \$54.99
		SWING WEIGHT: MIXED	FINISH: HARDLINE BLACK TO NATURAL
WOOD: MIX	TURNING MODEL: MIX	TOP COAT: REGULAR MATTE	IN: [29"] [30"] [31"] [32"] [33"] [34"]
			CUPPED: YES



GENUINE

NEW



GENUINE – NATURAL

WBL2689010

MSRP: 39.99



SWING WEIGHT:
MIXED

FINISH:
NATURAL

IN:
[31"] [32"] [33"] [34"]

WOOD: MIX

TURNING MODEL: MIX

TOP COAT: REGULAR MATTE

CUPPED: YES

NEW



GENUINE – BLACK

WBL2690010

MSRP: \$39.99



SWING WEIGHT:
MIXED

FINISH:
BLACK

IN:
[31"] [32"] [33"] [34"]

WOOD: MIX

TURNING MODEL: MIX

TOP COAT: REGULAR MATTE

CUPPED: YES

NEW



GENUINE – PINK

WBL2691010

MSRP: \$44.99



SWING WEIGHT:
MIXED

FINISH:
PINK

IN:
[31"] [32"] [33"] [34"]

WOOD: MIX

TURNING MODEL: MIX

TOP COAT: REGULAR MATTE

CUPPED: YES

NEW



GENUINE – BLUE

WBL2692010

MSRP: \$44.99



SWING WEIGHT:
MIXED

FINISH:
BLUE

IN:
[31"] [32"] [33"] [34"]

WOOD: MIX

TURNING MODEL: MIX

TOP COAT: REGULAR MATTE

CUPPED: YES



YOUTH PRIME



YOUTH PRIME CY22 YELICH			WBL2699010	MSRP: \$99.95
		SWING WEIGHT: TARGET DROP: -8(+/- 2oz)	FINISH: BLACK	IN: [28"] [29"] [30"] [31"]
WOOD: MAPLE	TURNING MODEL: CY22	TOP COAT: EXOPRO-PRO HARDCOAT		CUPPED: YES



YOUTH PRIME RA13 ACUÑA			WBL2700010	MSRP: \$99.95
		SWING WEIGHT: TARGET DROP: -8(+/- 2oz)	FINISH: FADE-BLACK TO NATURAL	IN: [28"] [29"] [30"] [31"]
WOOD: MLB® MAPLE	TURNING MODEL: RA13	TOP COAT: EXOPRO-PRO HARDCOAT		CUPPED: YES



YOUTH PRIME CB35 BELLINGER			WBL2701010	MSRP: \$99.95
		SWING WEIGHT: TARGET DROP: -8(+/- 2oz)	FINISH: NATURAL	IN: [28"] [29"] [30"] [31"]
WOOD: MLB® MAPLE	TURNING MODEL: CB35	TOP COAT: EXOPRO-PRO HARDCOAT		CUPPED: YES



YOUTH PRIME VG27 GUERRERO JR.			WBL2702010	MSRP: \$99.95
		SWING WEIGHT: TARGET DROP: -8(+/- 2oz)	FINISH: FADE-BLACK TO WINE	IN: [28"] [29"] [30"] [31"]
WOOD: MLB® MAPLE	TURNING MODEL: VG27	TOP COAT: EXOPRO-PRO HARDCOAT		CUPPED: YES



YOUTH FLYLITE



YOUTH FLYLITE – NAVY			WBL2703010	MSRP: \$39.99
		SWING WEIGHT: TARGET DROP: -10(+/- 2oz)	FINISH: NAVY	IN: [27"] [28"] [29"] [30"]
WOOD: POPLAR	TURNING MODEL: Y271	TOP COAT: REGULAR		CUPPED: YES



YOUTH FLYLITE – DARK GREY			WBL2704010	MSRP: \$39.99
		SWING WEIGHT: TARGET DROP: -10(+/- 2oz)	FINISH: DARK GREY	IN: [27"] [28"] [29"] [30"]
WOOD: POPLAR	TURNING MODEL: Y243	TOP COAT: REGULAR		CUPPED: YES

YOUTH GENUINE



YOUTH GENUINE – NATURAL			WBL2705010	MSRP: \$29.99
			FINISH: NATURAL	IN: [27"] [28"] [29"] [30"] [31"]
WOOD: MIX	TURNING MODEL: Y125	TOP COAT: REGULAR		CUPPED: YES



YOUTH GENUINE – BLACK			WBL2706010	MSRP: \$29.99
			FINISH: BLACK	IN: [27"] [28"] [29"] [30"] [31"]
WOOD: MIX	TURNING MODEL: Y125	TOP COAT: REGULAR		CUPPED: YES

YOUTH TEEBALL



YOUTH TEEBALL			WBL2707010	MSRP: \$24.99
			FINISH: NATURAL	IN: [26"]
WOOD: MIX	TURNING MODEL: TBALL	TOP COAT: REGULAR		CUPPED: YES



FUNGO

NEW



S345		WBL2708010	MSRP: \$74.99
		SWING WEIGHT: TARGET DROP: -12(+/- 2oz)	FINISH: FADE—SILVER TO BLACK IN: [35"]
WOOD: MAPLE	TURNING MODEL: S345	TOP COAT: EXOPRO—PRO HARDCOAT	

NEW



G160		WBL2709010	MSRP: \$74.99
		SWING WEIGHT: TARGET DROP: -12(+/- 2oz)	FINISH: FADE—GOLD TO BLACK IN: [36"]
WOOD: MAPLE	TURNING MODEL: G160	TOP COAT: EXOPRO—PRO HARDCOAT	

NEW



MB37		WBL2710010	MSRP: \$74.99
		SWING WEIGHT: TARGET DROP: -12(+/- 2oz)	FINISH: BLACK IN: [37"]
WOOD: POPLAR	TURNING MODEL: MB37	TOP COAT: EXOPRO—PRO HARDCOAT	

NEW



K100		WBL2711010	MSRP: \$34.99
		FINISH: NATURAL	IN: [36"]
WOOD: MIX	TURNING MODEL: K100	TOP COAT: EXOPRO—PRO HARDCOAT	



CATCHER'S GEAR

EVOSHIELD® & WILSON® CATCHER'S GEAR

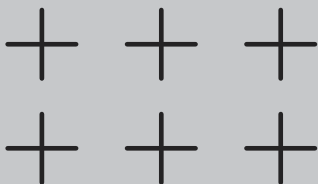

@EVOSHIELD #ALWAYSALLIN
@WILSONBALLGLOVE #TEAMWILSON

2023

THE MOST ADVANCED CATCHER'S GEAR EVER.

GO TO BATTLE WITH THE ONLY CUSTOM-MOLDED CATCHER'S PROTECTION IN THE GAME TODAY.

PRO-SRZ™ LEG GUARD SYSTEM

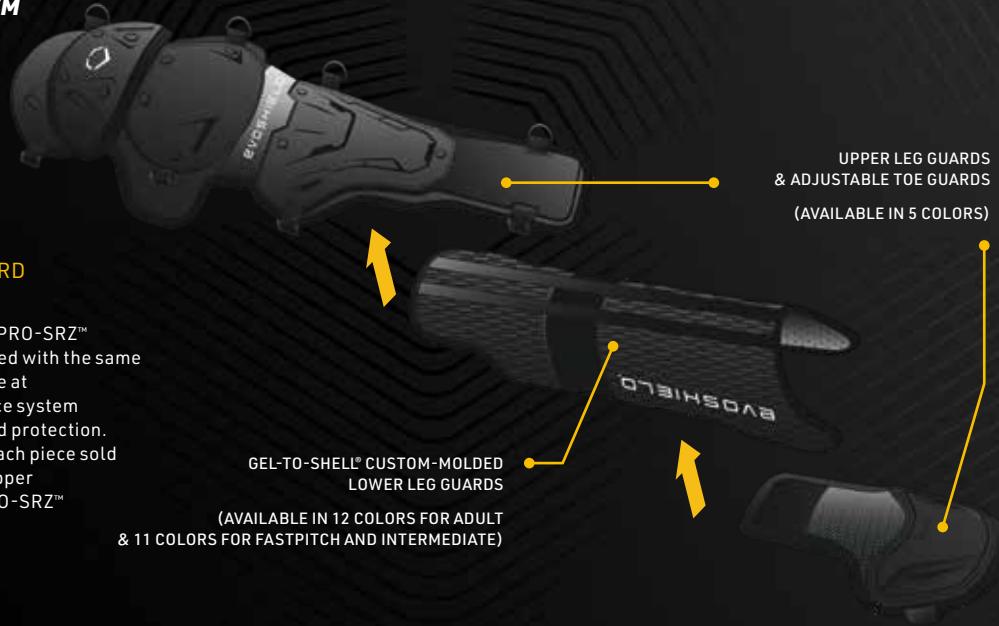

THE MOST ADVANCED LEG GUARD SYSTEM IN THE GAME

Shape the future with the EvoShield PRO-SRZ™ Catcher's Leg Guard System. Designed with the same Gel-to-Shell® innovation players love at the plate, this cutting-edge two-piece system guarantees unparalleled comfort and protection. To complete the leg guard system (each piece sold separately), attach the PRO-SRZ™ Upper Leg Guard to the custom-molded PRO-SRZ™ Lower Leg Guard.

GEL-TO-SHELL® CUSTOM-MOLDED LOWER LEG GUARDS

(AVAILABLE IN 12 COLORS FOR ADULT & 11 COLORS FOR FASTPITCH AND INTERMEDIATE)

UPPER LEG GUARDS & ADJUSTABLE TOE GUARDS

(AVAILABLE IN 5 COLORS)

CATCHER'S GEAR



OFFICIAL PROTECTIVE GEAR SUPPLIER OF MAJOR LEAGUE BASEBALL

HOW TO MEASURE EVOSHIELD CATCHER'S GEAR

PRO-SRZ HELMET

	Small	Medium	Large	PRO-SRZ HELMET SOLID	
Helmet Size				S/M	L/XL
Hat Size	6½ - 7	7 - 7½	7½ - 8	6¼ - 7	7 - 7¾
Circumference IN	20½ - 22	22 - 23½	23½ - 25	19¾ - 22	22 - 24¼
Circumference CM	52 - 55.8	55.8 - 59.6	59.6 - 63.5	50.1 - 55.8	55.8 - 61.5

HOW TO MEASURE

Measure the circumference of your head above your ears in inches or centimeters. Refer to the chart above to determine the best size.

PRO-SRZ CHEST PROTECTOR

Sport	Baseball	Baseball	Fastpitch	Fastpitch
Product Size	Adult 16"	Intermediate 15"	Adult 15"	Intermediate 13.5"
Chest Measurement	15" & Above	15" & Below	13.5" & Above	13.5" & Below

HOW TO MEASURE

Measure from the collarbone to the waist line in inches. If the player measure in between lengths, it is recommended to select the longer length.

PRO-SRZ LEG GUARD

Sport	Baseball	Baseball	Fastpitch
Product Size	Adult	Intermediate	OSFM
Leg Measurement	15.5 - 17.5"	13.5 - 15.5"	13.5 - 15.5"

HOW TO MEASURE

In a seated position, with your foot at a 90-degree angle to the floor, measure the distance in inches from the center of your kneecap to the bend of your ankle.





PRO-SRZ™ BASEBALL



PRO-SRZ™ BASEBALL CHEST PROTECTOR

ARTICLE (ADULT)	ARTICLE (INTERMEDIATE)	COLOR	MAP (ADULT)	MAP (INTERMEDIATE)
WB5709201	WB5709301	Black	\$199.95	\$179.95
WB5709202	WB5709302	Charcoal		
WB5709203	WB5709303	Navy		
WB5709204	WB5709304	Royal		
WB5709205	WB5709305	Scarlet		
WB5709206		USA (NEW)		

SIZES

ADULT 16" // INTERMEDIATE 15"

FIDLOCK® BUCKLE Strong magnetic design with slide release allows for easy on/off
MOLDABLE ABDOMINAL WIRE Adjustable custom fit keeps chest protector in place
NOCSAE® PROTECTIVE CHEST GUARD Built-in/Removable pocket houses NOCSAE® Chest Guard



PRO-SRZ™ BASEBALL UPPER LEG GUARDS

ARTICLE (ADULT)	ARTICLE (INTERMEDIATE)	COLOR	MAP (ADULT)	MAP (INTERMEDIATE)
WB5707901	WB5709401	Black	\$144.95	\$134.95
WB5707902	WB5709402	Charcoal		
WB5707903	WB5709403	Navy		
WB5707904	WB5709404	Royal		
WB5707905	WB5709405	Scarlet		
WB5707906		USA (NEW)		

SIZES

ADULT 15.5-17.5" // INTERMEDIATE 13.5-15.5"

ADJUSTABLE LENGTH Guard can be lengthened or shortened 2" for custom fit
STAYS IN PLACE Reinforced knee and thigh construction keeps gear in place
ENHANCED KNEE SUPPORT Adjustable knee pad engineered with comfort foam
TWO PIECE LEG GUARD SYSTEM Requires PRO-SRZ™ Lower Leg Guards



PRO-SRZ™ LOWER LEG GUARDS

ARTICLE (ADULT)	ARTICLE (INTERMEDIATE)	COLOR	MAP (ADULT)	MAP (INTERMEDIATE)
WB5708001	WB5710301	Black	\$179.95	\$169.95
WB5708002	WB5710302	Charcoal		
WB5708003	WB5710303	Dark Green		
WB5708004	WB5710304	Maroon		
WB5708005	WB5710305	Navy		
WB5708006	WB5710306	Orange		
WB5708007	WB5710307	Purple		
WB5708008	WB5710308	Royal		
WB5708009	WB5710309	Scarlet		
WB5708010	WB5710310	White		
WB5708011	WB5710311	Yellow		
WB5708012		USA (NEW)		

SIZES

ADULT 15.5-17.5" // INTERMEDIATE 13.5-15.5"

GEL-TO-SHELL® TECHNOLOGY Begins soft and flexible, transforms to hard and protective in minutes
DISPERSION TECHNOLOGY Spreads the force across the surface of the shield, minimizing felt impact

ERGONOMIC GUARD SHAPE with Gel-to-Shell® technology allow you to create a fully custom guard for protection behind the plate

TWO PIECE LEG GUARD SYSTEM Requires PRO-SRZ™ Upper Leg Guards





PRO-SRZ™ FASTPITCH CHEST PROTECTOR



ARTICLE (FASTPITCH)	ARTICLE (INTERMEDIATE)	COLOR	MAP (ADULT)	MAP (INTERMEDIATE)
WB5709001	WB5709101	Black	\$199.95	\$179.95
WB5709002	WB5709102	Charcoal		
WB5709003	WB5709103	Navy		
WB5709004	WB5709104	Royal		
WB5709005	WB5709105	Scarlet		
WB5709006	WB5709106	Team White (NEW)		

SIZES
FASTPITCH 15" // INTERMEDIATE 13.5"

FIDLOCK® BUCKLE Strong magnetic design with slide release allows for easy on/off
MOLDABLE ABDOMINAL WIRE Adjustable custom fit keeps chest protector in place
FEMALE DESIGN PATTERN Built and cut to be the most comfortable designed gear for the ladies protecting the plate

PRO-SRZ™ FASTPITCH UPPER LEG GUARDS



ARTICLE (FASTPITCH)	COLOR	MAP (FASTPITCH)
WB5708101	Black	\$134.95
WB5708102	Charcoal	
WB5708103	Navy	
WB5708104	Royal	
WB5708105	Scarlet	
WB5708106	Team White (NEW)	

SIZES
FASTPITCH 13.5-15.5"

ADJUSTABLE LENGTH Guard can be lengthened or shortened 2" for custom fit
STAYS IN PLACE Reinforced knee and thigh construction keeps gear in place
ENHANCED KNEE SUPPORT Adjustable knee pad engineered with comfort foam
TWO PIECE LEG GUARD SYSTEM Requires PRO-SRZ™ Lower Leg Guards

PRO-SRZ™ LOWER LEG GUARDS



ARTICLE (FASTPITCH)	COLOR	MAP (FASTPITCH)
WB5710301	Black	\$169.95
WB5710302	Charcoal	
WB5710303	Dark Green	
WB5710304	Maroon	
WB5710305	Navy	
WB5710306	Orange	
WB5710307	Purple	
WB5710308	Royal	
WB5710309	Scarlet	
WB5710310	White	
WB5710311	Yellow	

SIZES
FASTPITCH 13.5-15.5"

GEL-TO-SHELL® TECHNOLOGY Begins soft and flexible, transforms to hard and protective in minutes
DISPERSION TECHNOLOGY Spreads the force across the surface of the shield, minimizing felt impact
ERGONOMIC GUARD SHAPE with Gel-to-Shell® technology allow you to create a fully custom guard for protection behind the plate
TWO PIECE LEG GUARD SYSTEM Requires PRO-SRZ™ Upper Leg Guards





PRO-SRZ™ BASEBALL & FASTPITCH



PRO-SRZ™ CATCHER'S HELMET

ARTICLE	COLOR	MAP
WB5708401	Black	\$289.95
WB5708402	Charcoal	
WB5708403	Navy	
WB5708404	Royal	
WB5708405	Scarlet	
WB5708406	USA (NEW)	

SIZES

SMALL [6½ - 7] // MEDIUM [7 - 7½] // LARGE [7½ - 8]

SHOCK ABSORBING PADDING SYSTEM Windpact's Crash Cloud® technology absorbs and disperses impact energy, giving you greater protection and comfort

ENGINEERED FOR PERFORMANCE Durable steel facemask engineered for maximum field of vision and enhanced impact protection

GLOSSY FINISH Two-Tone color, light weight ABS shell

MEETS NOCSAE® STANDARD This helmet is certified by SEI to meet the NOCSAE® standard for baseball/softball catcher's helmets



NEW PRO-SRZ™ CATCHER'S HELMET SOLID



ARTICLE	COLOR	MAP
WB5720101	Black	\$189.95
WB5720102	Charcoal	
WB5720103	Navy	
WB5720104	Royal	
WB5720105	Scarlet	
WB5720106	White	

SIZES

S/M [6½ - 7¼] // L/XL [7 - 7¾]

COMFORT PADDING SYSTEM Foam padding absorbs and disperses impact energy, giving you greater protection and comfort

ENGINEERED FOR PERFORMANCE Durable steel facemask engineered for maximum field of vision and enhanced impact protection

GLOSSY FINISH Single color, light weight ABS shell

MEETS NOCSAE® STANDARD This helmet is certified by SEI to meet the NOCSAE® standard for baseball/softball catcher's helmets



PRO-SRZ™ CATCHER'S FACEMASK



ARTICLE	COLOR	MAP
WB5708501	Black	\$159.95
WB5708502	Charcoal	
WB5708503	Navy	
WB5708504	Royal	
WB5708505	Scarlet	

SIZES

ONE SIZE

SHOCK ABSORBING PADDING SYSTEM Windpact's Crash Cloud® technology absorbs and disperses impact energy, giving you greater protection and comfort

ENGINEERED FOR PERFORMANCE Durable steel facemask engineered for maximum field of vision and enhanced impact protection

NO-SLIP HARNESS Adjustable neoprene harness designed to hold mask in place





NEW PRO-SRZ™ VENTED SKULL CAP



ARTICLE	COLOR	MSRP
WB5729201	Black	\$34.99
WB5729202	Charcoal	
WB5729203	Navy	
WB5729204	Royal	
WB5729205	Scarlet	

SIZES
S/M [7¼ and below] // L/XL [7½ and above]

VENTED HOLES For air flow
COMFORT FOAM Padding
SEMI-GLOSS Finish
INTENDED FOR CATCHERS
TWO SIZES FIT MOST

PRO-SRZ™ SKULL CAP



ARTICLE	COLOR	MSRP
WB5708601	Black	\$34.99
WB5708602	Charcoal	
WB5708603	Navy	
WB5708604	Royal	
WB5708605	Scarlet	

SIZES
S/M [7¼ and below] // L/XL [7½ and above]

COMFORT FOAM Padding
SEMI-GLOSS Finish
TWO SIZES FIT MOST



SHOWN WITH PRO-SRZ™ CATCHER'S LEG GUARD SYSTEM



NEW CATCHER'S KNEE BLOCKS

ARTICLE	COLOR	MSRP
WB5718901	Black	\$39.95

SIZES
ADULT

2 INCH ADJUSTABLE RIDE HEIGHT Change your support height, unzip the pocket, remove foam wedge to adjust to your preferred height
USER-FRIENDLY DESIGN Simply slide your straps securely through the loops, no adjustments needed. No more taking apart your leg guards just to adjust your knee support
PREMIUM CONSTRUCTION Top of the line materials with no hard plastic or metal attachments, designed to contour to your body and maximize comfort behind the plate
BUILT FOR THE PRO-SRZ CATCHER'S LEG GUARD SYSTEM Compatible with most catcher's leg guards



CATCHER'S THROAT GUARD 4.5"

ARTICLE	COLOR	MSRP
WB5711501	Black	\$14.99

SIZES
ONE SIZE

ENGINEERED To securely mount to EvoShield catcher's helmets and facemasks
LIGHTWEIGHT ABS PLASTIC



C1K™ CATCHER'S GEAR

3-PIECE CATCHER'S SET WITH NOCSAE® APPROVED CHEST PROTECTION

C1K™ Catcher's Gear is designed for durability and sturdiness, but built with a professional style and feel. Whether you're an adult or intermediate player, the C1K™ Catcher's Gear set will protect you all season long.



ADULT



INTERMEDIATE

C1K™ CATCHER'S GEAR KIT

MODEL NO.	SIZE	MSRP (ADULT)	MSRP (INTERMEDIATE)
WTA4603	Adult	\$339.99	\$299.99
WTA4604	Intermediate		

Kit Includes:
Catcher's Helmet, Chest Protector and Leg Guards

Helmet:
Glossy finish • Removable moisture-wicking chin pad • Adjustable straps for custom fit • SEI CERTIFIED: Product meets NOCSAE® Applicable Standard



Sizes: Adult [71/8-7½], Intermediate [63/8-71/8]

Chest Protector:
High-density foam padding for ultimate comfort and protection • Removable shoulder caps for increased mobility • Over-the-shoulder adjustable harness • Precision, angled pad design to help block the ball straight down • SEI CERTIFIED: Product meets NOCSAE® Applicable Standard



Sizes: Adult [15"], Intermediate [13.5"]

Leg Guards:
Inner knee pad protects knees, removable for washing • Overlapping thigh pieces for maximum protection • Lightweight premium grade ABS plastic • Adjustable metal buckles for easy on/off and snug fit

Sizes: Adult [15.5"], Intermediate [14"]

ADULT SIZE: Recommended for ages 15+
INTERMEDIATE SIZE: Recommended for ages 12-15

AVAILABLE IN COLORS



BL BLACK NA NAVY RO ROYAL SC SCARLET



YOUTH CATCHER'S GEAR KITS

C200™ YOUTH CATCHER'S GEAR

Made from extra-tough, lightweight materials that keep you protected while easily moving with you. Designed for easy on and off between innings, the C200™ catcher's set will keep catchers of every skill level safe and in the game.



ARTICLE	SIZE	COLOR	MSRP
WB5711601	Youth (Age 7-12)	Black	\$229.99
WB5711602		Black/Orange	
WB5711603		Black/Scarlet	
WB5711604		Navy	
WB5711605		Navy/Scarlet	
WB5711606		Royal	
WB5711607		Scarlet	

Kit Includes:
Catcher's Helmet, Chest Protector and Leg Guards

Helmet:
Premium grade ABS shell with glossy finish • Moisture-wicking chin pad • SEI CERTIFIED: Product meets NOCSAE® applicable standard



Sizes: Youth [6 3/8-7 1/8]

Chest Protector:
High-density foam padding • Over-the-shoulder harness • Precision pad design to help block the ball down • NOCSAE® PROTECTIVE CHEST GUARD Built-in/Removable pocket houses NOCSAE® Chest Guard Included • NOCSAE® protective chest guard MUST be worn with this catcher's chest protector for the chest protector to adhere to NOCSAE® standards and regulations



Sizes: Youth [12"]

EVOSHIELD® NOCSAE PROTECTIVE CHEST GUARD



SAS-TEC™ GUARD extremely lightweight and durable protection. This chest guard is certified by SEI to meet the NOCSAE® standard for protection against Commotio Cordis. NOCSAE® chest guard MUST be worn with this catcher's chest protector for the chest protector to adhere to NOCSAE® standards and regulations.

Leg Guards:
Lightweight premium grade ABS plastic • Anatomically inspired design • Adjustable metal buckles for easy on/off and snug fit

Sizes: Youth [13"]

AVAILABLE IN COLORS



EZ GEAR™ 2 YOUTH CATCHER'S GEAR

Built with QuickChange™ technology for easy on-and-off between innings, the updated EZ Gear™ 2 kit features an improved ergonomic fit for catchers.



ARTICLE	SIZE	COLOR	MSRP
WB5720201	L/XL (Ages 7-12) S/M (Ages 5-7)	Black	\$159.99
WB5720204		Navy	
WB5720206		Royal	
WB5720207		Scarlet	

Kit Includes:
Catcher's Helmet, Chest Protector and Leg Guards

Helmet:
Premium grade ABS shell with glossy finish • Venting technology to maintain protection while keeping your head cool • Meets NOCSAE® protection standard.



Sizes: S/M [6-7] L/XL [7-7 7/8]

Chest Protector:
One-time-adjustable QuickChange™ system – set it and forget it • Easy on/off hook and loop closure • Form fitting design • Removable shoulder caps • Multi-point adjustment system

Sizes: S/M [11"] L/XL [13"]

Leg Guards:
One-time-adjustable QuickChange™ system – set it and forget it • Easy on/off hook and loop closure • Form fitting design

Sizes: S/M [10 1/2"] L/XL [12"]

AVAILABLE IN COLORS

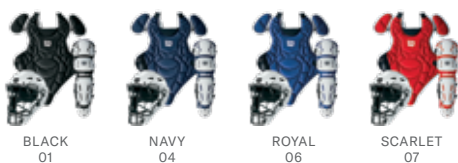

The Wilson Pro Gold™ 2 Chest Protector boasts a modernized fit and customizable features to perfectly conform to your body. Available with two padding types – Air Management for maximum protection or Memory Foam for a low profile – the chest protector features a magnetic Fidlock® buckle for secure protection behind the plate. The improved Wilson leg guards include adjustable ankle plates with a hybrid padding system for custom protection.



PRO GOLD™ 2 CHEST PROTECTOR - MEMORY FOAM

ARTICLE	SIZE	COLOR	MSRP
WB5720301	S/M, M/L, L/XL	Black/Charcoal	\$249.95

Low profile memory foam padding for comfort fit • HINGED SHOULDER PLATES For maximum protection and mobility • FIDLOCK® BUCKLE Strong magnetic design with slide release allows for easy on/off • COMFORT NEOPRENE HARNESS With adjustable elastic straps for perfect fit • EXTRA SIDE PROTECTION Around the ribs for extra comfort and protection

SIZE: S-M [11"] M-L [12"] L-XL [13"]



PRO GOLD™ 2 CHEST PROTECTOR - AIR MANAGEMENT

ARTICLE	SIZE	COLOR	MSRP
WB5720401	S/M, M/L, L/XL	Black	\$229.95

Air management system, lightweight with maximum protection • HINGED SHOULDER PLATES For maximum protection and mobility • FIDLOCK® BUCKLE Strong magnetic design with slide release allows for easy on/off • COMFORT NEOPRENE HARNESS With adjustable elastic straps for perfect fit • EXTRA SIDE PROTECTION Around the ribs for extra comfort and protection

SIZE: S-M [11"] M-L [12"] L-XL [13"]



PRO GOLD™ 2 CHEST PROTECTOR HARNESS

ARTICLE	SIZE	COLOR	MSRP
WB5720601	OS	Black	\$39.99

ADJUSTABLE CHEST PROTECTOR HARNESS WITH FIDLOCK® BUCKLE CLOSURE • LONG, ADJUSTABLE ELASTIC STRAPS To better fit all body types • NEOPRENE COMFORT HARNESS With Wilson Gold "W" Strap

DIMENSIONS: Shoulder Straps (measured from base) [14"] Body Straps (measured from base [19"] Total Width [42"]



PRO GOLD™ 2 LEG GUARDS

ARTICLE	SIZE	COLOR	MSRP
WB5720501	S/M, M/L, L/XL	Black	\$149.95



HYBRID PADDING SYSTEM Air management foam with memory foam center channel • EXTENDED FOAM PADDING Around knee cap for 180 degree protection • ADJUSTABLE ANKLE PLATES For custom protection • REMOVABLE/ADJUSTABLE Hook and loop toe cap





DIMENSIONS: S/M [14.5"-16"] M/L [15.5"-17.5"] L/XL [17"-18.5"]



BUILD YOUR OWN FACEMASK

Select your preferred facemask pads, cage & harness to craft your facemask just how you want it. Pick out your facemask pads and choose from titanium, aluminum and steel cage options to complete your custom facemask.

CAGE & HARNESS	DYNA-LITE™		
			
ARTICLE	WB5720801	WB5720901	WB5720701
MATERIAL	TITANIUM	ALUMINUM	STEEL
COLOR	NATURAL	BLACK	BLACK
MSRP	\$220.95	\$99.95	\$49.95

FACEMASK PADS				
	ARTICLE	WB5721001	WB5721301	WB5721201
MATERIAL	FULL GRAIN LEATHER	PU/LEATHER	SYNTHETIC LEATHER	MEMORY FOAM
COLOR	TAN	BLACK/TAN	BLACK	BLACK
MSRP	\$59.95	\$49.95	\$39.95	\$39.95

UMPIRE HELMETS	PRO STOCK™		THROAT PROTECTOR REPLACEMENT MASK HARNESS	
				
STOCK NO.	WTA5800BL	WTA5801BL	WTA3901 BLA: 6" WTA3902 BLA: 4"	WTA3927
SIZE	7-7½	7-7½		
CAGE MATERIAL	TITANIUM	STEEL	Throat Protector	Three-Point Adjustable Umpire Facemask Replacement Harness
FRAMES	Matte Finish	Glossy Finish	• Durable ABS plastic throat protector • Header card and polybag packaging	• High-stretch elastic and durable webbing • Secure, quick adjusting buckles
PAD TYPE	Removable Moisture-Wicking Pads	Removable Moisture-Wicking Pads		
MSRP	\$329.99	\$159.99	\$9.99	\$14.99



UMPIRE KIT

MODEL NO.	MSRP
WTA6754	\$14.99

Includes umpire brush, ball strike counter and ball bag

COACH ACCESSORIES



LINE-UP CARDS

MODEL NO.	MSRP
WTA6761	\$17.99

Boxed Line-up Cards (30 pack)



SPIRAL SCOREBOOK

MODEL NO.	MSRP
WTA3753	\$14.99

New, easy to read format • Includes pitch counter • Enough pages to record 30 games

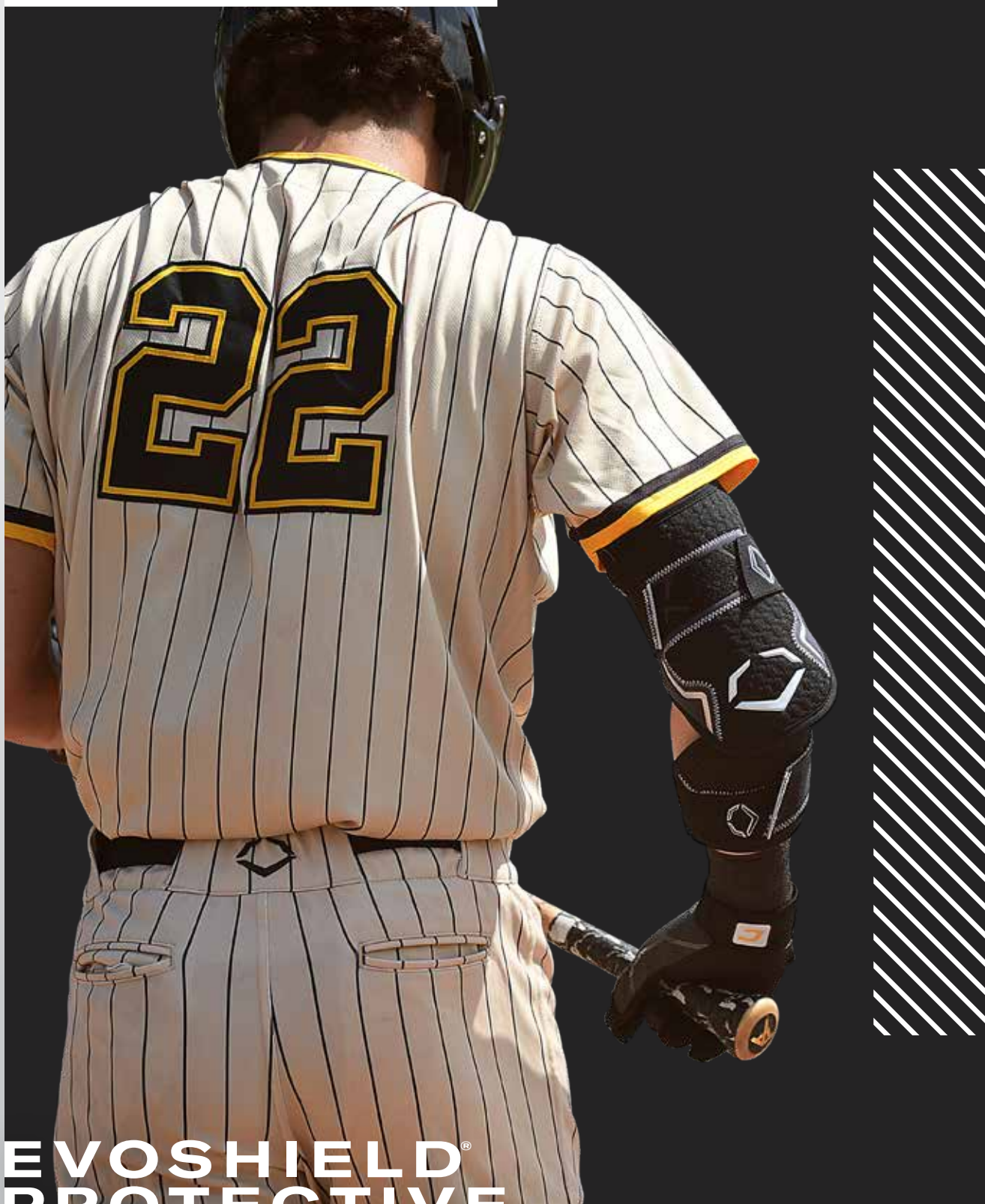

PROTECTIVE GEAR

EVOSHIELD[®] PROTECTIVE GEAR

2023

@EVOSHIELD

#ALWAYSALLIN

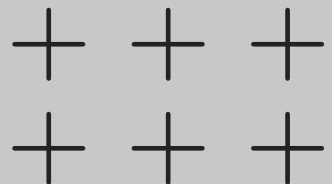

NO DOUBT. ALL IN.



Custom Molded Gear
Gel-To-Shell™ products are the only custom-fitted protective gear on the market.



Gel-To-Shell™ Technology
For a true-to-you fit, our form-fitting tech transforms your guard into a custom shield.



Dispersion Technology
Evenly redistributes force across the entire surface of the guard and away from the point of impact to better protect against severe injury than soft, flexible, and ill fitting guards.

INTRODUCING PRO-SRZ™ 2.0





NEW PRO-SRZ™ 2.0 ELBOW GUARD

ARTICLE	SIZE	ARTICLE	SIZE	COLOR	MAP
WB5726001	Large	WB5726001	Small	Black	\$69.95
WB5726002	Large	WB5726002	Small	White	
WB5726003	Large	WB5726003	Small	Navy	
WB5726004	Large	WB5726004	Small	Royal	
WB5726005	Large	WB5726005	Small	Scarlet	
WB5726006	Large	WB5726006	Small	Sand	

NEW ERGONOMIC DESIGN Engineered for a more personalized fit and maximum protection
GEL-TO-SHELL® TECHNOLOGY Begins soft and flexible, transforms to hard and protective in minutes
DISPERSION TECHNOLOGY Spreads the force across the surface of the shield, minimizing felt impact
CUSTOM MOLDED GEAR All Products that feature Gel-to-Shell Technology offer the player a truly custom fit
COMFORT MESH On interior of the guard for a smoother fit
GUARD COVERAGE LARGE: [9.25" W x 7" H] // **SMALL:** [7.5" W x 5.5" H]
10% MORE COVERAGE THAN PRO-SRZ 1.0



NEW PRO-SRZ™ 2.0 DOUBLE STRAP ELBOW GUARD

ARTICLE	SIZE	ARTICLE	SIZE	COLOR	MAP
WB5726501	Large	WB5726501	Small	Black	\$89.95
WB5726502	Large	WB5726502	Small	White	
WB5726503	Large	WB5726503	Small	Navy	
WB5726504	Large	WB5726504	Small	Royal	
WB5726505	Large	WB5726505	Small	Scarlet	
WB5726506	Large	WB5726506	Small	Sand	

NEW ERGONOMIC DESIGN Engineered for a more personalized fit and maximum protection
GEL-TO-SHELL® TECHNOLOGY Begins soft and flexible, transforms to hard and protective in minutes
DISPERSION TECHNOLOGY Spreads the force across the surface of the shield, minimizing felt impact
CUSTOM MOLDED GEAR All Products that feature Gel-to-Shell Technology offer the player a truly custom fit
COMFORT MESH On interior of the guard for a smoother fit
GUARD COVERAGE LARGE: [9.25" W x 9" H w/ double strap] // **SMALL:** [7.5" W x 7" H w/ double strap]



NEW PRO-SRZ™ 2.0 TWO PIECE ELBOW GUARD

ARTICLE	COLOR	SIZE	MAP
WB5726701	Black	OS	\$109.95
WB5726702	White	OS	
WB5726703	Navy	OS	
WB5726704	Royal	OS	
WB5726705	Scarlet	OS	
WB5726706	Sand	OS	

NEW ERGONOMIC DESIGN Engineered for a more personalized fit and maximum protection
GEL-TO-SHELL® TECHNOLOGY Begins soft and flexible, transforms to hard and protective in minutes
DISPERSION TECHNOLOGY Spreads the force across the surface of the shield, minimizing felt impact
CUSTOM MOLDED GEAR All Products that feature Gel-to-Shell Technology offer the player a truly custom fit
COMFORT MESH On back of guard for a smoother fit
GUARD COVERAGE UPPER SHIELD [9" W x 7.5" H with single strap] **LOWER SHIELD** [7.5" W x 5.5" H with single strap]





PRO-SRZ™ BASEBALL & FASTPITCH

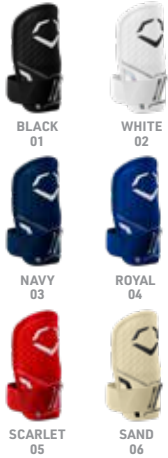

NEW PRO-SRZ™ 2.0 HAND GUARD

ARTICLE	HAND	ARTICLE	HAND	COLOR	MAP
WB5726801	RHH	WB5726801	LHH	Black	\$59.95
WB5726802	RHH	WB5726802	LHH	White	
WB5726803	RHH	WB5726803	LHH	Navy	
WB5726804	RHH	WB5726804	LHH	Royal	
WB5726805	RHH	WB5726805	LHH	Scarlet	
WB5726806	RHH	WB5726806	LHH	Sand	

NEW ERGONOMIC DESIGN Engineered for a more personalized fit and maximum protection
GEL-TO-SHELL® TECHNOLOGY Begins soft and flexible, transforms to hard and protective in minutes
DISPERSION TECHNOLOGY Spreads the force across the surface of the shield, minimizing felt impact
CUSTOM MOLDED GEAR All Products that feature Gel-to-Shell Technology offer the player a truly custom fit

COMFORT MESH On interior of the guard for a smoother fit
GUARD COVERAGE BACK OF HAND [4" W x 4" H] // OUTSIDE WRIST [3.5" W x 2" H]



NEW PRO-SRZ™ 2.0 LEG GUARD

ARTICLE	HAND	ARTICLE	HAND	COLOR	MAP
WB5726901	RHH	WB5726901	LHH	Black	\$99.95
WB5726902	RHH	WB5726902	LHH	White	
WB5726903	RHH	WB5726903	LHH	Navy	
WB5726904	RHH	WB5726904	LHH	Royal	
WB5726905	RHH	WB5726905	LHH	Scarlet	
WB5726906	RHH	WB5726906	LHH	Sand	

NEW ERGONOMIC DESIGN Engineered for a more personalized fit and maximum protection
GEL-TO-SHELL® TECHNOLOGY Begins soft and flexible, transforms to hard and protective in minutes
DISPERSION TECHNOLOGY Spreads the force across the surface of the shield, minimizing felt impact
CUSTOM MOLDED GEAR All Products that feature Gel-to-Shell Technology offer the player a truly custom fit

BATTER'S STANCE Choose RHH for right-handed hitters (worn on LEFT leg) and LHH for left-handed hitters (worn on RIGHT leg)

COMFORT MESH On interior of the guard for a smoother fit
GUARD COVERAGE Extending to protect inner ankle [8.5" W x 12" H]



NEW PRO-SRZ™ 2.0 GUARD STRAP

ARTICLE	COLOR	ARTICLE	COLOR	MSRP
WB5733501	Black	WB5733506	Scarlet	\$19.99
WB5733502	Navy	WB5733507	Sand	
WB5733503	Orange	WB5733508	Victory Blue	
WB5733504	Pink	WB5733509	White	
WB5733505	Royal	WB5733510	Yellow	

SIZE OSFA

CUSTOMIZE YOUR LOOK With a pop of color, compatible with all Gel-to-Shell® elbow and leg guards
2 INCH ELASTIC STRAP Adjustable for desired guard compression
STRAP DIMENSIONS 12.25" L x 2" W





PRO-SRZ™ BATTER'S ELBOW GUARD

MODEL NO. / ARTICLE	SIZE	COLOR	MAP
WB5714701	Large	X-SRZ USA20 Navy	\$64.95
WB5714701	Small	X-SRZ USA20 Navy	
WTV6200	Large	BL, WH, RO, SC, NA	\$59.95
WTV6201	Small	BL, WH, RO, SC, NA	

ERGONOMIC DESIGN Engineered for a more personalized fit and maximum protection
GEL-TO-SHELL® TECHNOLOGY Begins soft and flexible, transforms to hard and protective in minutes
DISPERSION TECHNOLOGY Spreads the force across the surface of the shield, minimizing felt impact
SHIELD IS HAND WASHABLE Air dry
GUARD COVERAGE LARGE: [9.25" W x 6.5" H] // SMALL: [7.5" W x 5.5" H]



PRO-SRZ™ BATTER'S DOUBLE STRAP ELBOW GUARD

ARTICLE	SIZE	COLOR	MAP
WB5714801	Large	X-SRZ USA20 Navy	\$84.95
WB5706601	Large	Black	\$79.95
WB5706602	Large	White	
WB5706603	Large	Royal	
WB5706604	Large	Scarlet	
WB5706605	Large	Navy	

ERGONOMIC DESIGN Engineered for a more personalized fit and maximum protection
GEL-TO-SHELL® TECHNOLOGY Begins soft and flexible, transforms to hard and protective in minutes
DISPERSION TECHNOLOGY Spreads the force across the surface of the shield, minimizing felt impact
SHIELD IS HAND WASHABLE Air dry
GUARD COVERAGE LARGE: [9.25" W x 9" H w/ double strap] // SMALL: [9.25" W x 7" H w/ double strap]



PRO-SRZ™ BATTER'S LEG GUARD

MODEL NO.	SIZE/ HITTER	COLOR	MAP
WTV1200	ADULT LHH, ADULT RHH	BL, WH, RO, SC, NA	\$89.95

ERGONOMIC DESIGN Engineered for a more personalized fit and maximum protection
GEL-TO-SHELL® TECHNOLOGY Begins soft and flexible, transforms to hard and protective in minutes
DISPERSION TECHNOLOGY Spreads the force across the surface of the shield, minimizing felt impact
SHIELD IS HAND WASHABLE Air dry
GUARD COVERAGE 8.5" W x 12" H, extending to protect inner ankle
BATTER'S STANCE Choose RHH for right-handed hitters (worn on LEFT leg) // LHH for left-handed hitters (worn on RIGHT leg)





PRO-SRZ™ BASEBALL & FASTPITCH



PRO-SRZ™ YOUTH BATTER'S LEG GUARD

MODEL NO.	SIZE	COLOR	MAP
WTV1201	Youth	BL, WH	\$79.95

ERGONOMIC DESIGN Engineered for a more personalized fit and maximum protection
GEL-TO-SHELL® TECHNOLOGY Begins soft and flexible, transforms to hard and protective in minutes
DISPERSION TECHNOLOGY Spreads the force across the surface of the shield, minimizing felt impact
SHIELD IS HAND WASHABLE Air dry
GUARD COVERAGE 7.5" W x 9.5" H, extending to protect both ankles
BATTER'S STANCE For right-handed, left-handed and switch hitters



WSL PRO-SRZ™ GUARD STRAP

MODEL NO.	SIZE	COLOR	MSRP
WTVSTRP	OS	BL, GR, GY, MA, NA, OR, PR, RO, SC, WH, YE	\$19.99

CUSTOMIZE YOUR LOOK With a pop of color, compatible with all Gel-to-Shell® elbow and leg guards
2 INCH ELASTIC STRAP Adjustable for desired guard compression
STRAP DIMENSIONS 12.25" L x 2" W



PRO-SRZ™ PROTECTIVE WRIST GUARD

MODEL NO.	SIZE	COLORS	MAP
WTV5200	S-XL	BL, NA, RO, SC, WH	\$39.95

SOFT NEOPRENE Compression sleeve with molded pull tab and interior pocket for Gel-to-Shell® Wrist Shield (included)
GEL-TO-SHELL® TECHNOLOGY Begins soft and flexible, transforms to hard and protective in minutes
DISPERSION TECHNOLOGY Spreads the force across the surface of the shield, minimizing felt impact
SLEEVE AND SHIELD ARE HAND WASHABLE air dry
SIZING Measure your wrist circumference to determine the best fit
S: [5"-6"] // **M:** [6"-7"] // **L:** [7"-8"] // **XL:** [8"-9"]





BL

SRZ-1™ YOUTH BATTER'S ELBOW GUARD

MODEL NO.	SIZE	COLORS	MAP
WTV6114	Youth	BL	\$39.95

GEL-TO-SHELL® TECHNOLOGY Begins soft and flexible, transforms to hard and protective in minutes
 DISPERSION TECHNOLOGY Spreads the force across the surface of the shield, minimizing felt impact
 CUSTOM-MOLDING SHIELD Molds to user's body shape, ensuring a perfect fit, custom molds to fit left or right-handed hitters
 SHIELD IS HAND WASHABLE Air dry
 GUARD COVERAGE YOUTH: [8" W x 5" H]



WRIST GUARD SHOWN LACED TO CATCHER'S MITT



CATCHER'S WRIST GUARD

ARTICLE	SIZE	COLORS	MSRP
WB5714001	OS	BL	\$69.99

GEL-TO-SHELL® TECHNOLOGY Begins soft and flexible, transforms to hard and protective in minute
 DISPERSION TECHNOLOGY Spreads the force across the surface of the shield, minimizing felt impact
 CUSTOM-MOLDING SHIELD Molds to user's body shape, ensuring a perfect fit, laces to catcher's mitt and molds to wrist
 SHIELD IS HAND WASHABLE Air dry
 GUARD COVERAGE [5"W x 4"H]
 LACE INCLUDED 18" Black Leather Lace



HOW TO MEASURE EVOSHIELD ELBOW & LEG GUARDS

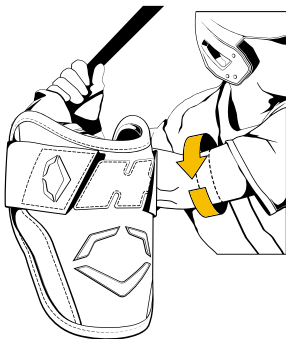

ELBOW GUARD

PRODUCT	HEIGHT	ARM CIRCUMFERENCE
Large Pro-SRZ Elbow Guard	6.5"	> 10"
Small Pro-SRZ Elbow Guard	5.5"	< 10"
Large Pro-SRZ Double Strap Elbow Guard	9"	> 10"
Small Pro-SRZ Double Strap Elbow Guard	7"	< 10"

HOW TO MEASURE
 Measure your arm circumference slightly above the elbow to determine best fit

LEG GUARD

PRODUCT	HEIGHT
Adult Pro-SRZ Leg Guard	12"
Youth Pro-SRZ Leg Guard	9.5"

HOW TO MEASURE
 Measurements are from top of inside leg to bottom of ankle protection

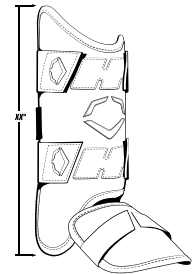



WSL NOCSAE® PROTECTIVE CHEST GUARD & SHIRT

MODEL NO.	SIZE	COLORS	MAP
WTV3200	Adult: S-L	BL	\$59.95
WTV3200	Youth: YS-YL	BL	

SLEEVELESS CHEST GUARD SHIRT WITH Built-in pocket for SAS-TEC protective insert, shirt is machine washable

TWO PIECE COLLAR AND SIDE MESH PANELS For comfort and breathability

FABRIC 85% Nylon, 15% Spandex

SEI CERTIFIED Product meets NOCSAE® Applicable Standard



NOCSAE® PROTECTIVE CHEST GUARD

SAS-TEC™ GUARD extremely lightweight and durable protection

This chest guard is certified by SEI to meet the NOCSAE® standard for protection against Commotio Cordis. NOCSAE® chest guard MUST be worn with this shirt for the shirt to adhere to NOCSAE® standards and regulations.



LIMITED QUANTITY MEN'S SLEEVELESS CHEST GUARD

MODEL NO.	SIZE	COLORS	MAP
WTV3100	Adult: S-L	CH	\$59.95
WTV3100	Youth: YS-YL	CH	

GEL-TO-SHELL® TECHNOLOGY Begins soft and flexible, transforms to hard and protective in minutes

DISPERSION TECHNOLOGY Spreads the force across the surface of the shield, minimizing felt impact

CUSTOM-MOLDING SHIELD Molds to user's body shape, ensuring a perfect fit

SWEAT-WICKING PERFORMANCE SHIRT Designed for increased comfort for the male athlete, machine washable

SHIELD IS HAND WASHABLE Air dry



LIMITED QUANTITY WOMEN'S RACERBACK CHEST GUARD

MODEL NO.	SIZE	COLORS	MAP
WTV1144103 049	Womens: S-L	GY	\$59.95
WTV1144103 049	Girls: YS-YL	GY	

GEL-TO-SHELL® TECHNOLOGY Begins soft and flexible, transforms to hard and protective in minutes

DISPERSION TECHNOLOGY Spreads the force across the surface of the shield, minimizing felt impact

CUSTOM-MOLDING SHIELD Molds to user's body shape, ensuring a perfect fit

SWEAT-WICKING RACERBACK SHIRT Designed for increased comfort and support for the female athlete. Machine washable

SHIELD IS HAND WASHABLE Air dry





CATCHER'S THUMB GUARD

ARTICLE	SIZE	COLORS	MAP
WTV4000BL	SM, LX	BL	\$24.95

GEL-TO-SHELL® TECHNOLOGY Begins soft and flexible, transforms to hard and protective in minutes
 DISPERSION TECHNOLOGY Spreads the force across the surface of the shield, minimizing felt impact
 CUSTOM-MOLDING SHIELD Molds to user's body shape, ensuring a perfect fit, molds to fit left or right thumb, worn under glove
 SHIELD IS HAND WASHABLE Air dry
 GUARD COVERAGE LARGE: [4.5" x 4.5"] // SMALL: [4.5"x3.25"]



SLIDING MITT

MODEL NO. / ARTICLE	COLORS	SIZE	MAP
WTV4054	BL, NA, RO, SC	LT/RT	\$49.95
WB5020401	USA (NEW)	LT/RT	
WB5020402	White (NEW)	LT/RT	
WB5020403	Light Gold (NEW)	LT/RT	
WB5020404	Olive (NEW)	LT/RT	
WB5020405	Sand (NEW)	LT/RT	
WB5020406	Victory Blue (NEW)	LT/RT	

HAND RT (Right) // LT (Left)

PROTECTIVE SHIELDS Cover the top and underside of the hand to protect fingers when sliding
 ELASTIC COMPRESSION STRAP Secures and supports wrist, adjustable for quick on and off
 THUMB HOLE For the ability to keep your thumb out, or tuck it in
 GUARD COVERAGE [4" x 11"]



NEW YOUTH SLIDING MITT

ARTICLE	COLORS	MAP
WB5733801	Black	\$49.95

HAND Compatible for either LH or RH

PROTECTIVE SHIELDS Cover the top and underside of the hand to protect fingers when sliding
 ELASTIC COMPRESSION STRAP Secures and supports wrist, adjustable for quick on and off
 THUMB HOLE For the ability to keep your thumb out, or tuck it in
 REVERSIBLE Compatible for either LH or RH
 GUARD COVERAGE [3.75" x 9"]



EVOSHIELD[®] BATTING HELMETS

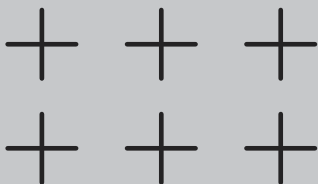
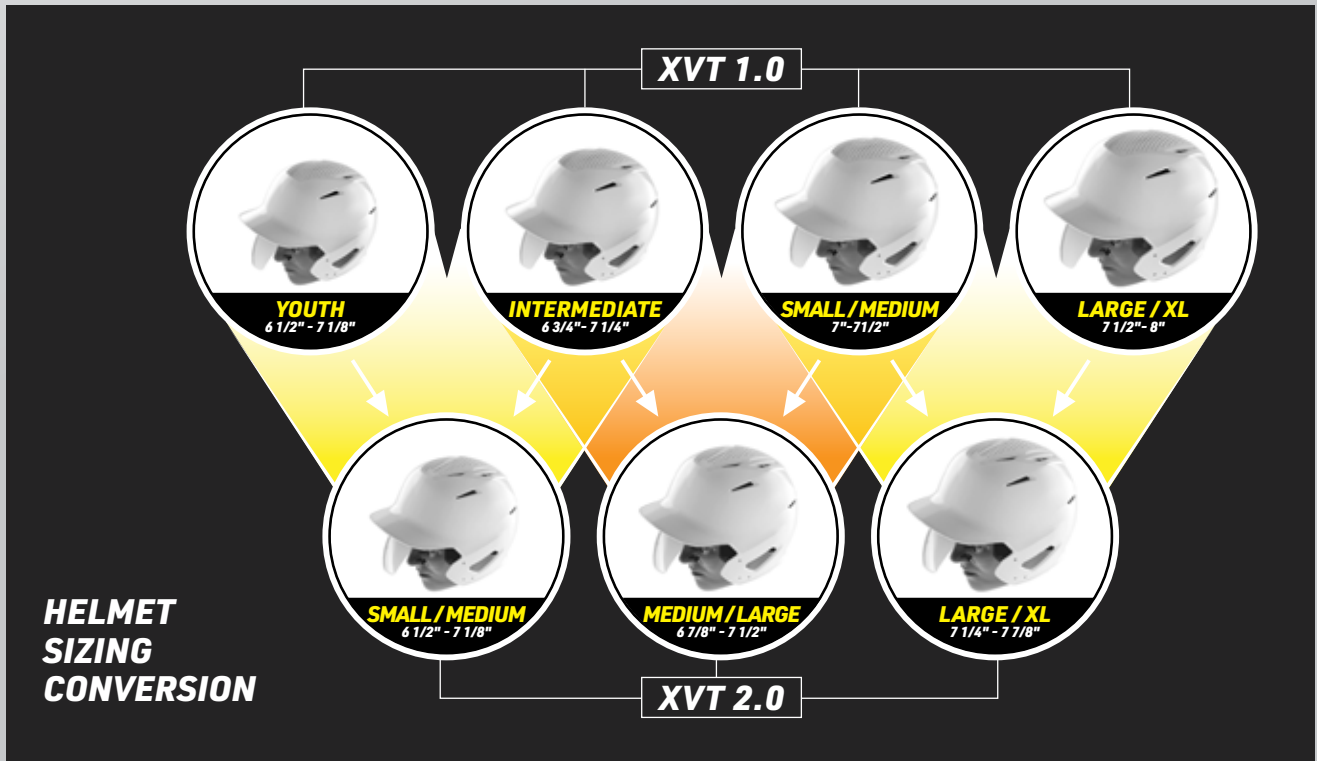



TOP OF HELMET

HELMET INTERIOR

NEW XVT™ 2.0 MATTE BATTING HELMET

ARTICLE	COLORS	SIZE	MSRP
WB5725601	Black	S/M, M/L, L/XL	\$49.99
WB5725602	Charcoal	S/M, M/L, L/XL	
WB5725603	Navy	S/M, M/L, L/XL	
WB5725604	Royal	S/M, M/L, L/XL	
WB5725605	Scarlet	S/M, M/L, L/XL	
WB5725606	Team White	S/M, M/L, L/XL	

NEW XVT™ 2.0 MATTE BATTING HELMET WITH FACEMASK

ARTICLE	COLORS	SIZE	MSRP
WB5725701	Black	S/M, M/L, L/XL	\$59.99
WB5725702	Charcoal	S/M, M/L, L/XL	
WB5725703	Navy	S/M, M/L, L/XL	
WB5725704	Royal	S/M, M/L, L/XL	
WB5725705	Scarlet	S/M, M/L, L/XL	
WB5725706	Team White	S/M, M/L, L/XL	

FITTED CAP SIZE S/M [6 1/2" - 7 1/8"] // M/L [6 7/8" - 7 1/2"] // L/XL [7 1/4" - 7 7/8"]

LIGHTWEIGHT DUAL DENSITY PADDING strategically placed for maximum comfort and protection available in two premium finishes high gloss and matte
 ANTI-MICROBIAL TREATED FOAM & FABRIC To remove bacteria and odor
 STRATEGICALLY ENGINEERED Top plate venting system
 SEI CERTIFIED Product meets NOCSAE® Applicable Standard



NEW XVT™ 2.0 GLOSS BATTING HELMET

ARTICLE	COLORS	SIZE	MSRP
WB5725801	Black	S/M, M/L, L/XL	\$49.99
WB5725802	Charcoal	S/M, M/L, L/XL	
WB5725803	Navy	S/M, M/L, L/XL	
WB5725804	Royal	S/M, M/L, L/XL	
WB5725805	Scarlet	S/M, M/L, L/XL	
WB5725806	Team White	S/M, M/L, L/XL	

NEW XVT™ 2.0 GLOSS BATTING HELMET WITH FACEMASK

ARTICLE	COLORS	SIZE	MSRP
WB5725901	Black	S/M, M/L, L/XL	\$59.99
WB5725902	Charcoal	S/M, M/L, L/XL	
WB5725903	Navy	S/M, M/L, L/XL	
WB5725904	Royal	S/M, M/L, L/XL	
WB5725905	Scarlet	S/M, M/L, L/XL	
WB5725906	Team White	S/M, M/L, L/XL	

FITTED CAP SIZE S/M [6 1/2" - 7 1/8"] // M/L [6 7/8" - 7 1/2"] // L/XL [7 1/4" - 7 7/8"]

LIGHTWEIGHT DUAL DENSITY PADDING strategically placed for maximum comfort and protection available in two premium finishes high gloss and matte
 ANTI-MICROBIAL TREATED FOAM & FABRIC To remove bacteria and odor
 STRATEGICALLY ENGINEERED Top plate venting system
 SEI CERTIFIED Product meets NOCSAE® Applicable Standard





WSL XVT™ LUXE FITTED BATTING HELMET

MODEL NO.	SIZE	MSRP
WTV7210	XS-2X	\$54.99
WTV7230 w/ Softball Mask	XS-2X	\$74.99

DUAL DENSITY PADDING Fully wrapped padding, fitted to your head size for a custom fit feel

PREMIUM HIGH GLOSS FINISH

STRATEGICALLY ENGINEERED Top plate venting system

SEI CERTIFIED Product meets NOCSAE® Applicable Standard

SIZES XS [6 5/8 - 6 3/4] // S [6 7/8 - 7] // M [7 1/8 - 7 1/4] // L [7 3/8 - 7 1/2], XL [7 5/8 - 7 3/4] // 2X [7 7/8 - 8]



HIGH GLOSS SCARLET

WSL XVT™ BATTING HELMET

MODEL NO.	SIZE	MSRP
WTV7110 (Glossy)	YH, INT, S/M, L/XL	\$44.99
WTV7130 w/ Softball Facemask (Glossy)	YH, INT, S/M, L/XL	\$54.99
WTV7115 (Matte)	YH, INT, S/M, L/XL	\$44.99
WTV7135 w/ Softball Mask (Matte)	YH, INT, S/M, L/XL	\$54.99

SLEEK COMPRESSION MOLDED FOAM PADDING With fully wrapped ear pads

AVAILABLE IN TWO PREMIUM FINISHES High Gloss and Matte

STRATEGICALLY ENGINEERED Top plate venting system

SEI CERTIFIED Product meets NOCSAE® Applicable Standard

SIZES YH [6 1/2-7] // INT [6 3/4-7 1/4] // S/M [7-7 1/2] // L/XL [7 1/2-8]



HIGH GLOSS

MATTE



CHARCOAL MATTE





XVT™ BATTING HELMET FACE SHIELD

MODEL NO.	HITTER	MSRP
WTV7300 (Glossy)	LHH, RHH	\$19.99
WTV7305 (Matte)	LHH, RHH	

ENGINEERED TO SECURELY MOUNT TO XVT™ BATTING HELMET Easy installation needs only two total screws (hardware included)
SUPERIOR COMFORT AND SIGHTLINES Lightweight ABS plastic with padded inner surface, tilt adjustment to maximize sightline
PROTECTS SIDE OF FACE EXPOSED TO PITCHER Choose right hand hitter (RHH) for right-handed hitters or left hand hitter (LHH) for left-handed hitters
AVAILABLE IN TWO PREMIUM FINISHES HIGH GLOSS AND MATTE
DOES NOT AFFECT THE SEI NOCSAE® certification of the EvoShield® XVT™ Batting Helmets when properly installed
COMPATIBLE with XVT 1.0 and XVT 2.0 products



XVT™ BATTING HELMET FACEMASK



MODEL NO.	SIZE	MSRP
WTV7330 Softball [For use with 11 inch softballs or larger]	SM, LG	\$14.99

GREAT SIGHT LINES Design optimized for increased visibility
ADJUSTABLE CHINSTRAP Included
EASY INSTALL Only four total screws (hardware included)
SMALL MASK FITS XVT™ Batting helmet sizes [YH, INT and S/M]
LARGE MASK FITS XVT™ Batting helmet sizes [M/L and L/XL]
COMPATIBLE with XVT 1.0 and XVT 2.0 products



BATTING HELMET CHIN STRAP



SKU	SIZE	MSRP
WTV7200BLO5FM	OSFM	\$3.99

ENGINEERED TO BETTER SECURE HELMET for uninterrupted performance
FULLY ADJUSTABLE For custom fit and comfort
COMPATIBLE With all EvoShield® batting helmets



EVOSHIELD®
& LOUISVILLE SLUGGER®
BATTING GLOVES

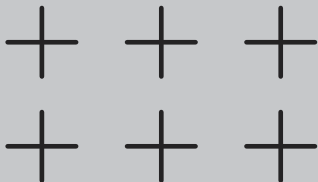

@EVOSHIELD #ALWAYSALLIN
@SLUGGERNATION #LOUISVILLELOYAL

2023



NEW PRO-SRZ™ V2 BATTING GLOVES

ARTICLE (ADULT)	COLOR	MSRP
WB5730501	Black	\$54.99
WB5730502	Navy	
WB5730503	Royal	
WB5730504	Scarlet	
WB5730505	Team White	
WB5730506	USA	

SIZES ADULT: S-2X

LIGHTWEIGHT PERFORMANCE Knit backhand
VENTED HOLES For breathability and enhanced comfort
PITTARDS® SHEEPSKIN LEATHER Allows for increased grip
LYCRA GUSSETS For flexibility and full range of motion
LUMINOUS IRIDESCENT accents
MOLDED NEOPRENE CUFF Allows for quick and easy adjustments



KHAOS BATTING GLOVES



ARTICLE (ADULT)	ARTICLE (YOUTH)	COLOR	MSRP
WB5722001	WB5722101	Black	\$44.99
WB5722002	WB5722102	Navy	
WB5722003	WB5722103	Royal	
WB5722004	WB5722104	Scarlet	
WB5722005	WB5722105	Team White	

SIZES ADULT: S-2X // YOUTH: YS-YL

LIGHTWEIGHT SUEDE backhand
STRATEGICALLY PLACED PERFORMANCE MESH For breathability and enhanced comfort
SHEEPSKIN LEATHER PALM Allows for increased grip
LYCRA GUSSETS For flexibility
MOLDED NEOPRENE CUFF Makes adjustments quick and easy



STANDOUT BATTING GLOVES



ARTICLE (ADULT)	ARTICLE (YOUTH)	COLOR	MSRP
WB5712801	WB5712901	Black	\$39.99
WB5712809	WB5712909	Team White	
WB5712813	WB5712913	Team White/Navy	
WB5712816	WB5712916	Team White/Royal	
WB5712817	WB5712917	Team White/Scarlet	
WB5712818	WB5712918	Team White/Black	

SIZES ADULT: S-2X // YOUTH: YS-YL

BREATHABLE 4 WAY STRETCH MESH BACKHAND For maximum breathability
SHEEPSKIN PALM Allows for enhanced comfort
LYCRA GUSSETS For flexibility
NEOPRENE CUFF For precise comfort fit
TECH6 INNER GRIP LINER Minimizes movement between your hand and the glove





DAZE BATTING GLOVES

ARTICLE (ADULT)	ARTICLE (YOUTH)	COLOR	MSRP
WB5722201	WB5722301	Black	\$34.99
WB5722202	WB5722302	Navy	
WB5722203	WB5722303	Royal	
WB5722204	WB5722304	Scarlet	
WB5722205	WB5722305	Team White	

SIZES ADULT: S-2X // YOUTH: YS-YL

SUBLIMATED TIE DYE Mesh backhand
 SYNTHETIC PALM For more comfort at the plate
 LYCRA GUSSETS For flexibility
 NEOPRENE CUFF Makes in-game adjustments easier
 IRIDESCENT APPLIED LOGO



SRZ-1™ BATTING GLOVES



ARTICLE (ADULT)	ARTICLE (YOUTH)	COLOR	MSRP
WB5712001	WB5712101	Black	\$29.99
WB5712002	WB5712102	Dark Green	
WB5712003	WB5712103	Maroon	
WB5712004	WB5712104	Navy	
WB5712005	WB5712105	Orange	
WB5712006	WB5712106	Purple	
WB5712007	WB5712107	Royal	
WB5712008	WB5712108	Scarlet	
WB5712009	WB5712109	Team White	
WB5712010	WB5712110	USA	
WB5712011	WB5712111	Victory Blue	

SIZES ADULT: S-2X // YOUTH: YS-YL

ONE-PIECE EMBOSSED Synthetic palm
 BREATHABLE 4 WAY STRETCH MESH BACKHAND For maximum breathability
 LYCRA GUSSETS For flexibility
 NEOPRENE CUFF For precise comfort fit



NEW GENUINE™ BATTING GLOVES

ARTICLE (ADULT)	ARTICLE (YOUTH)	COLOR	MSRP
WB5730701	WB5730801	Black	\$24.99
WB5730702	WB5730802	Purple/Pink	
WB5730703	WB5730803	Team White/Grey	
WB5730704	WB5730804	USA	

SIZES ADULT: S-2X // YOUTH: S-L

PERFORATED PU BACKHAND For breathability and enhanced comfort
 SYNTHETIC PALM For comfortable grip at the plate
 PATTERNED LYCRA
 LYCRA INSERTS For flexibility
 NEOPRENE CUFF Makes in-game adjustments easier





GEAR BAGS



EVOSHIELD, DEMARINI & WILSON GEAR BAGS

2023

#ALWAYSALLIN

#DEMARINI

#LOUISVILLELOYAL

#TEAMWILSON

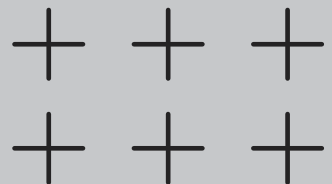



CUSTOMIZATION PANEL

EXEC BACKPACK

ARTICLE	COLOR	MSRP
WB5717801	Black	\$99.95
WB5717802	Navy	
WB5717803	Olive	

DIMENSIONS 11.5" W x 7" D x 19.75" H

- COATED RECYCLED POLYESTER FABRIC
- LARGE MAIN COMPARTMENT For everyday use
- FLEECE LINED ACCORDION Organizational pocket
- PADDED TABLET COMPARTMENT With pen loop and key leash
- VENTED PADDED Laptop compartment
- TWO EXTERNAL WATER BOTTLE COMPARTMENTS
- REAR LUGGAGE LOOP



REMOVABLE CUSTOMIZATION PANEL

STANDOUT BACKPACK

MODEL NO.	DIMENSIONS	MSRP
WTV9101	12" W x 9" D x 23" H	\$89.99

- MAIN COMPARTMENT Fits helmet, gloves and gear
- VENTED Shoe compartment
- FLEECE LINED Cell phone pocket
- 2 NEOPRENE BAT SLEEVES With elastic straps
- TUBULAR WEBBING On outside of the bag for elbow and leg guards
- DURABLE J-Style fence hook
- PADDED MESH BACKING And shoulder straps
- REMOVABLE Decoration panel
- PREMIUM MOLDED EVOSHIELD LOGO





REMOVABLE
CUSTOMIZATION
PANEL

NEW TONE SET BACKPACK

ARTICLE	COLOR	MSRP
WB5730401	Black	\$89.95
WB5730402	Charcoal	
WB5730403	Navy	
WB5730404	Royal	
WB5730405	Scarlet	
WB5730406	Team White	
WB5730407	USA	

DIMENSIONS 12.25" W x 12" D x 19" H

LARGE MAIN COMPARTMENT Fits helmet, glove and gear

NEOPRENE BAT SLEEVES Holds up to 2 bats

FLEECE LINED Cell phone pocket

MESH Water bottle slot

SHOE Compartment

1 INTEGRATED Fence hook

REMOVABLE DECORATION PANEL

WATER RESISTANT Shell fabric

PADDED Shoulder straps and back paneling

CORDED Zipper pulls



CUSTOMIZATION
PANEL

SRZ-1™ BACKPACK

ARTICLE	COLOR	MSRP
WB5717901	Black	\$59.99
WB5717902	Charcoal	
WB5717903	Navy	
WB5717904	Royal	
WB5717905	Scarlet	
WB5717906	USA	

DIMENSIONS 12" W x 9" D x 18" H

MAIN COMPARTMENT Holds youth glove, helmet and additional gear

2 MESH BAT SLEEVES That can double up as water bottle slots

FRONT VALUABLES POCKET

TWO TUBULAR WEBBING LOOPS For protective elbow and leg guard or batting gloves

HIDDEN DURABLE J-Style Fence hook

FRONT DECORATION PANEL

CORDED Zipper pulls



NEW CINCH BAG

ARTICLE	DIMENSIONS	MSRP
WB5729501	15" W x 18.5" L	\$19.99

LARGE Main compartment

ZIPPERED Accessory pocket

LARGE AREA For customization

2 TONE Drawstring cinch closure



REMOVABLE CUSTOMIZATION PANEL



STONEWALL WHEELED BAG

MODEL NO.	DIMENSIONS	MSRP
WTV9400	38" L x 17" W x 12" H	\$199.95

MAIN COMPARTMENT Fits a whole set of catcher's gear, batting helmet and more

FITS 4 bats comfortably

EXTERIOR SLIP POCKET With bloused lining to store shin guards

VENTED SHOE COMPARTMENT With drop lining

HIGH RISE WHEEL CHASSIS With inline wheels for smooth roll

ACCESSORY POCKET With hidden mesh zippered pocket

FLEECE LINED Zippered cell phone pocket

TELESCOPIC Pull handle

PREMIUM Molded EvoShield logo

REMOVABLE CUSTOMIZATION PANEL



REMOVABLE CUSTOMIZATION PANEL



STANDOUT WHEELED BAG

ARTICLE	COLOR	MSRP
WB5719101	Black	\$149.95
WB5719102	Charcoal	
WB5719103	Navy	
WB5719104	Royal	
WB5719105	Scarlet	

DIMENSIONS 38" L x 14" W x 14" H

LARGE MAIN COMPARTMENT Fits helmet, glove, and cleats and complete set of catcher's gear

INDIVIDUALLY Padded bat sleeves

REINFORCED INTERNAL SHELF

WHEEL CHASSIS 3" clearance and inline wheels

EXTENDED BOTTOM RAILS With PE Board backing

2 INTEGRATED Fence hooks

2 EXTERNAL Valuables pockets

INTERNAL Zippered mesh pocket

REMOVABLE DECORATION PANEL

PLASTIC CORNER CATERPILLARS To add reinforcement





CUSTOMIZATION PANEL



NEW TONE SET WHEELED BAG

ARTICLE	COLOR	MSRP
WB5730301	Black	\$119.99
WB5730302	Charcoal	
WB5730303	Navy	
WB5730304	Royal	
WB5730305	Scarlet	

DIMENSIONS 37" L x 14" W x 11" H

- LARGE MAIN COMPARTMENT Fits helmet, glove and gear
- LARGE VALUABLES POCKET Big enough to fit a glove
- ZIPPERED BAT COMPARTMENT Will hold 4 bats comfortably
- HIGH RISE WHEEL CHASSIS With inline wheels
- INTERIOR ZIPPERED Mesh pocket
- 1 INTEGRATED Fence hook
- EXTENDED BOTTOM RAILS With PE Board backing
- WATER RESISTANT Shell fabric
- SIDE SLIT POCKET To stash water bottle
- LARGE OPENING On main panel for team decoration



CUSTOMIZATION PANEL



NEW GAME DAY DUFFLE

ARTICLE	COLOR	MSRP
WB5729801	Black	\$99.99
WB5729802	Navy	
WB5729803	Royal	
WB5729804	Scarlet	

DIMENSIONS 33" L x 15" W x 15" H

- MAIN COMPARTMENT Fits helmet, gloves, additional gear
- #10 LOCKING ZIPPER On main compartment
- YKK ZIPPERS Throughout the bag
- LARGE VENTED COMPARTMENT For shoes or wet gear
- WATER RESISTANT Bottom
- LUGGAGE ID Window
- PADDED Carry handle
- TWO TUBULAR GRAB HANDLES For easy loading
- LARGE OPENING On main panel for team decoration



REMOVABLE CUSTOMIZATION PANEL



PLAYERS DUFFLE

MODEL NO./ARTICLE	COLOR	MSRP
WTV9301	Black, Navy, Royal, Scarlet	\$79.99
WB5028802	Charcoal (NEW)	\$79.99
DIMENSIONS	26" L x 13" W x 13" H	

- MAIN COMPARTMENT Fits helmet, gloves, gear and more
- VENTED Shoes or wet gear compartment with drop lining
- FLEECE LINED Cell phone pocket
- DIVIDED BAT SLEEVES Compartment holds 2 bats
- TUBULAR WEBBING On outside of the bag for elbow and leg guards
- COMPOSITE TREATED BOTTOM To protect against the elements
- PADDED CARRY HANDLE And fence hook
- SHOULDER STRAP With swivel speed clips
- PREMIUM Molded EvoShield logo
- REMOVABLE CUSTOMIZATION PANEL





SPECTRE BACKPACK

ARTICLE	COLOR	MSRP
WB5717601	Black	\$129.95
WB5717602	Heather Grey	
WB5717603	Navy	
DIMENSIONS 13.5" W x 8.5 D x 24" H		

- EXTRA-LARGE MAIN COMPARTMENT
- NEOPRENE BAT SLEEVES Holds 4 bats
- INTERIOR SHELF With snap reinforcement
- FLEECE LINED VALUABLES POCKETS With internal organizational pockets
- LARGE THERMAL FOIL LINED POCKET For drinks and snacks
- PADDED SHOULDER STRAPS And back paneling
- FINGER LOOP Zipper pulls
- REMOVABLE DECORATION PANEL
- INTEGRATED Fence hooks (2)



BL-01 HG-02 NA-03



VOODOO XL BACKPACK

ARTICLE	COLOR	MSRP
WB5710801	Black	\$89.99
WB5710802	Navy	
WB5710803	Royal	
WB5710804	Scarlet	
WB5710805	Team White	
WB5710806	USA	
DIMENSIONS 13.25" W X 12.50" D X 22.50" H		

- LARGE MAIN COMPARTMENT Fits helmet, glove and gear
- PERFORATED NEOPRENE BAT SLEEVES Holds up to 2 bats
- MESH WATER BOTTLE SLOT Can be utilized to hold an additional bat
- EQUIPMENT STRAP To carry your helmet, glove or protective equipment on the outside of your bag
- FLEECE LINED Cell phone pocket
- THERMAL POCKET For your drink or game day snack
- INTEGRATED Fence hooks (2)
- WATER RESISTANT Bottom
- LARGE SIZE 10 ZIPPERS On main opening
- REMOVABLE DECORATION PANEL
- PADDED SHOULDER STRAPS And back paneling
- CORDED Zipper pulls



BL-01 NA-02 RO-03 SC-04 TW-05 USA-06





VOODOO OG BACKPACK

ARTICLE	COLOR	ARTICLE	COLOR	MSRP
WB5711701	Black	WB5711709	Royal	\$79.99
WB5711702	Charcoal	WB5711710	Scarlet	
WB5711703	Dark Green	WB5711711	Team White	
WB5711704	Light Gold	WB5711712	USA	
WB5711705	Maroon	WB5711713	Victory Blue	
WB5711706	Navy	WB5711721	Cardinal	
WB5711707	Orange	WB5711722	Texas Orange	
WB5711708	Purple	WB5711723	Vegas Gold	
DIMENSIONS 12.25" W X 12" D X 19" H				

LARGE MAIN COMPARTMENT Fits helmet, glove and more

NEOPRENE BAT SLEEVES Hold up to 2 bats

FLEECE LINED Cell phone pocket

MESH WATER BOTTLE SLOT

SHOE COMPARTMENT

2 ADDITIONAL Front valuables pockets

INTEGRATED Fence hook (1)

REMOVABLE DECORATION PANEL

WATER RESISTANT Bottom

PADDED SHOULDER STRAPS And back paneling

CORDED Zipper pulls

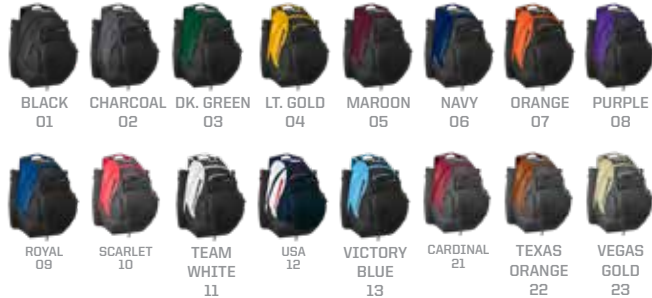

VOODOO JUNIOR BACKPACK

MODEL NO.	DIMENSIONS	MSRP
WTD9106	11.5" W X 9" D X 17" H	\$44.99

LARGE MAIN COMPARTMENT Fits helmet, glove and gear

MESH BAT SLEEVES Holds up to 2 bats and doubles as water bottle holders

VALUABLES POCKET

INTEGRATED Fence hook (1)

PADDED Shoulder straps and back

CUSTOMIZATION AREA





SPECTRE WHEELED BAG

ARTICLE	DIMENSIONS	MSRP
WB5717701	38" L x 18" W x 11" H	\$299.95

- PADDED BAT SLEEVES Holds 6 bats
- REINFORCED Side walls
- INTERNAL SHELVES With snap reinforcement
- LARGE THERMAL FOIL LINED POCKET For drinks and snacks
- FLEECE-LINED VALUABLES POCKET
- HARD BODY CONSTRUCTION
- TELESCOPIC PULL HANDLE
- INTERIOR ZIPPERED Mesh pockets
- SEPARATE INTERIOR BAG For small accessories
- INLINE WHEELS For smooth roll
- SIZE 10 ZIPPERS AND FINGER LOOP PULLS On main compartments
- 2 J-STYLE FENCE HOOKS
- REMOVABLE DECORATION PANEL



BLACK
01



SPECIAL OPS® FRONT LINE WHEELED BAG

ARTICLE	COLOR	MSRP
WB5710901	Black	\$229.95
WB5710902	Navy	
WB5710904	USA	
DIMENSIONS 38" L x 13.5" W x 11" H		

- ARMoured BAT COMPARTMENT Holds up to 4 bats (4 individual slots)
- BREATHABLE Shoe compartment
- HEAVY DUTY INTERIOR SHELVES Reinforced with snaps
- HARD BODY CONSTRUCTION
- INLINE WHEELS
- TELESCOPING PULL HANDLE
- 6 ADDITIONAL EXTERIOR POCKETS With 1 fleece lined pocket
- SIZE 10 ZIPPERS On main openings of bag
- 2 FENCE HOOKS
- 2 BOTTOM RAILS
- FINGER LOOP Zipper pulls
- PADDED TUBULAR WEBBING Front load handles
- RUBBERIZED 3D LOGO
- REMOVABLE EMBROIDERY PANEL
- PERFECT SIZE FOR ALL LEVEL BALL PLAYERS Youth leagues to adult slowpitch



BLACK
01

NAVY
02

USA
04



REMOVABLE
CUSTOMIZATION
PANEL

PRIME STICK PACK 2.0

ARTICLE	COLOR	MSRP
WB5711001	Black	\$119.95
WB5711002	Navy	
WB5711003	Royal	
WB5711004	Scarlet	
WB5711005	Team White	

DIMENSIONS 14" W X 9" D X 24" H

MAIN COMPARTMENT With interior shelf fits helmet, glove, gear and more

NEOPRENE BAT SLEEVES Holds 4 bats

FLEECE LINED valuables pocket

3 ADDITIONAL Outside accessories pockets

WATER RESISTANT BOTTOM

2 FENCE CLIPS

REMOVABLE DECORATION PANEL

PADDED Backing and shoulder straps



OMAHA STICK PACK

ARTICLE	COLOR	MSRP
WB5717501	Black	\$59.99
WB5717502	Charcoal	
WB5717503	Navy	
WB5717504	Royal	
WB5717505	Scarlet	

DIMENSIONS 13" W X 8" D X 20" H

MAIN COMPARTMENT Fits helmet, glove and gear

BAT SLEEVES With stretch panel to hold two bats

SHOE Pocket

VALUABLES pocket

DURABLE J-Style fence hook

REMOVABLE DECORATION PANEL

CORDED Zipper pulls



REMOVABLE
CUSTOMIZATION
PANEL



NEW GENUINE V2 STICK PACK

ARTICLE	COLOR	MSRP
WB5729701	Black	\$34.99
WB5729702	Navy	
WB5729703	Purple	
WB5729704	Royal	
WB5729705	Scarlet	
WB5729706	USA	

DIMENSIONS 12" W x 8.5" D x 17" H

- MAIN COMPARTMENT** Fits helmet, glove and youth cleats
- 2 MESH BAT SLEEVES** That double up as water bottle slots
- ZIPPED** Accessory pocket
- FOAM PADDED** Shoulder straps
- 1 INTEGRATED** Fence hook

CUSTOMIZATION AREA



A2000® BACKPACK

ARTICLE	COLOR	MSRP
WB5718001	Charcoal	\$109.95
WB5718003	Olive	

DIMENSIONS 11.5" W X 6.75" D X 19.25" H

- LARGE MAIN COMPARTMENT** For everyday use
- DURABLE CORDURA POLYESTER** shell fabric
- PADDED** Laptop and tablet compartment
- INTERNAL MESH** Water bottle pocket
- LUGGAGE LOOP**
- FLEECE** Valuables pocket
- SMALL ACCESSORY POCKET** With key leash
- CORDED ZIPPER PULLS** With leather details
- YKK VISLON** Zippers
- SEATBELT WEBBING**
- MOLDED BACK** With thick ergonomic shoulder straps
- EXTERNAL A2000 GLOVE LOOP**



CUSTOMIZATION AREA



TEAM GEAR BAG ON WHEELS

ARTICLE	DIMENSIONS	MSRP
WTA9710BL	39.5" L X 14" W X 15" H	\$69.99

- OVERSIZED** Multi-purpose gear bag
- RIG BOTTOM** With support rails and interior support bracket
- FITS MULTIPLE** Helmets, bats and set of catcher's gear

CUSTOMIZATION AREA



REMOVABLE CUSTOMIZATION AREA

WILSON® TEAM GEAR BAG

MODEL NO.	DIMENSIONS	MSRP
WTA9709	40" L X 14.5" W X 13" H	\$59.99

EXTRA LARGE MAIN COMPARTMENT Fits helmet, gloves, cleats & a complete set of catcher's gear

SEPARATE VENTILATED COMPARTMENT For shoes, wet gear or catcher's helmet

#8 ZIPPERS On main opening

HANDLES On both sides for easy loading

REMOVABLE CUSTOMIZATION PANEL



REMOVABLE CUSTOMIZATION AREA



BALL BUCKET BAG

ARTICLE	DIMENSIONS	MSRP
WB5710701	27" L X 14.5" D X 20.50" H	\$ 159.95

MAIN COMPARTMENT Holds 2 Six gallon bucket of baseballs or softballs

MOLDED FOAM BASED BOTTOM Secure the buckets from shifting during transportation

ADJUSTABLE INTERIOR WEBBING STRAP To secure buckets in place

3 EXTERIOR POCKETS For score book and other small accessories

LARGE WHEELS For smooth roll

2 LOAD HANDLES For easy loading in and out of vehicles

2 BOTTOM RAILS

SKID PLATE BETWEEN WHEELS To prevent abrasion

TELESCOPIC PULL HANDLE

REMOVABLE DECORATION PANEL

WHEELED UMPIRE BAG

ARTICLE	DIMENSIONS	MSRP
WTA9780BL	36" L X 16" W X 15" H	\$159.99

SEPARATE UPPER AND LOWER COMPARTMENTS Allow you to separate gear from clothing

SEPARATE VENTED Shoe compartment

COMFORT-GRIP CARGO HANDLE For easy pulling

INLINE WHEELS WITH RAILS Attached to wheel housing for added support

INTERIOR POCKET For umpire accessories

PVC CORNER STOPS For durability

OFFICIAL UMPIRE GEAR OF MLB®





HIGH SCHOOL STATE ADOPTIONS

AHSAA	ALABAMA
AIA	ARIZONA
CAA	ARIZONA
AAA	ARKANSAS
CIF	CENTRAL COAST CALIFORNIA
CIF	CENTRAL CALIFORNIA
CIF	SAN JOAQUIN CALIFORNIA
CHSAA	COLORADO
DIAA	DELAWARE
DCSAA	DISTRICT OF COLUMBIA
FHSA	FLORIDA
FICAA	FLORIDA
GHSA	GEORGIA
GISA	GEORGIA
GICAA	GEORGIA
IHSA	ILLINOIS
IHSAA	INDIANA
MPSSA	MARYLAND
MHSAA	MICHIGAN
MSHSL	MINNESOTA
MHSAA	MISSISSIPPI
MAIS	MISSISSIPPI
NIAA	NEVADA
NHIAA	NEW HAMPSHIRE
NJSIAA	NEW JERSEY
NMAA	NEW MEXICO
NCHSAA	NORTH CAROLINA
NCISAA	NORTH CAROLINA
OSSAA	OKLAHOMA
OSAA	OREGON
SCHSL	SOUTH CAROLINA
TSSAA	TENNESSEE
TAPPS	TEXAS
TCAL	TEXAS
UHSAA	UTAH
VHSL	VIRGINIA
VISAA	VIRGINIA
WVSSAC	WEST VIRGINIA

BASEBALLS/SOFTBALLS

WILSON® & DEMARINI® BASEBALLS & SOFTBALLS

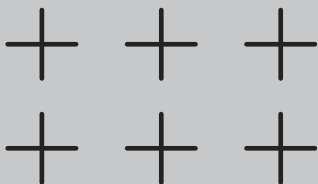

@WILSONBALLGLOVE #TEAMWILSON @DEMARINI #DEMARININATION

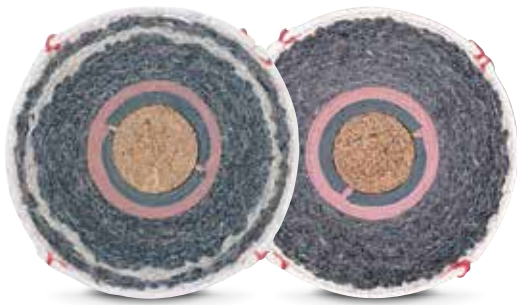

DURA-CORE TECHNOLOGY™

RED CUSHIONED CORK

CORES BASEBALL



SUPER SEAM TECHNOLOGY™



FLAT SEAMS

SEAMS BASEBALL



DURA-CORE TECHNOLOGY™:

Added to Red Cushioned Cork to help the ball retain hardness. Formed to withstand impact and give you the game-changing performance you need.

RED CUSHIONED CORK:

Gives a Wilson® baseball the ability to keep its shape and firmness, allowing for better pop off the bat.

SUPER SEAM TECHNOLOGY™:

With seams 20% higher than raised seam baseballs, pitchers experience superior control on the mound. Fielders can locate the ball quickly in their gloves and throw with more accuracy.

FLAT SEAMS:

The most aerodynamic Wilson® baseball, these balls fly further, giving both pitchers and hitters a true feel of the ball.

PRO SERIES: COLLEGIATE AND HIGH SCHOOL ELITE GAME PLAY

A1001

STOCK NO.
WTA1001BFS

COVER
Grade A Full Grain Leather

SEAM WINDS
Flat Premium Gray & White Wool

CENTER
Red Cushioned Cork with
Dura-Core Technology™



A1010 PRO

STOCK NO.
WTA1010BPROFS*
WTA1010BPROSST

COVER
Grade A Full Grain Leather

SEAM WINDS
SST Premium Gray & White Wool
Flat Premium Gray & White Wool

CENTER
Red Cushioned Cork with
Dura-Core Technology™

*WILL NOT HAVE NFHS/NOCSAE STAMP



A1010 HS1

STOCK NO.
WTA1010BHS1SST

COVER
Grade B Full Grain Leather

SEAM WINDS
SST Gray Wool

CENTER
Red Cushioned Cork with
Dura-Core Technology™



A110 HS1 AMERICAN LEGION

STOCK NO.
WTA1010BHS1AL1

COVER
Grade B Full Grain Leather

SEAM WINDS
SST Gray Wool

CENTER
Red Cushioned Cork with
Dura-Core Technology™



AVAILABLE IN RETAIL PACK

STOCK NO.
WTA1010THS1SST

A1015

STOCK NO.
WTA1015BSST

COVER
Grade C Full Grain Leather

SEAM WINDS
SST Gray Wool

CENTER
Red Cushioned Cork with
Dura-Core Technology™



CHAMPION SERIES: GAME PLAY AND PRACTICE

A1020

STOCK NO.
WTA1020BSST

COVER
Grade C
Full Grain Leather

SEAM WINDS
SST Gray Wool

CENTER
Red Cushioned Cork with
Dura-Core Technology™



A1030

STOCK NO.
WTA1030B
WTA1030BFS

COVER
Grade C/D
Full Grain Leather

SEAM WINDS
SST Gray Wool
Flat Gray Wool

CENTER
Red Cushioned Cork

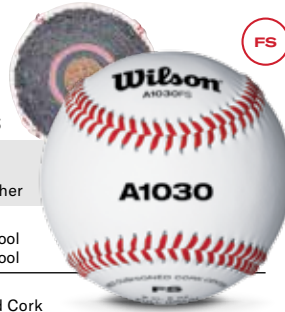

A1035

STOCK NO.
WTA1035B0

COVER
Grade C/D
Full Grain Leather

SEAM WINDS
SST Gray Wool

CENTER
Black Cork & Rubber

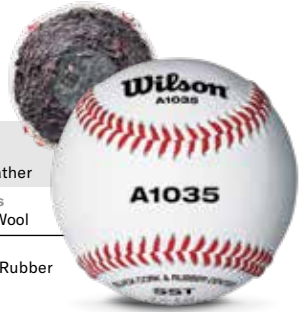

TOURNAMENT SERIES: YOUTH LEAGUE ELITE GAME PLAY

SST SERIES
AVAILABLE WITH
THE FOLLOWING
STAMPS:

COVER
Grade C/D Full Grain Leather

SEAM WINDS
SST Gray Wool

CENTER
Red Cushioned Cork



LEAGUE SERIES: YOUTH LEAGUE GAME PLAY

1 SERIES
AVAILABLE WITH
THE FOLLOWING
STAMPS:

COVER
Grade C/D Full Grain Leather

SEAM WINDS
SST Gray Wool

CENTER
Black Cork & Rubber





PRACTICE BALLS

A1060

STOCK NO.
WTA1060B

COVER
White Split Leather

SEAM WINDS
SST Gray Wool

CENTER
Cork & Rubber



A1274

COVER
White Split Leather

SEAM
SST

CENTER
Cork & Rubber

AVAILABLE IN RETAIL PACK ONLY

STOCK NO.
WTA1274T WTA1274WSHRINK



RETAIL SERIES

A1250

COVER
Synthetic Leather

SEAM
Flat

HITS
Good for up to 15 hits

AVAILABLE IN RETAIL PACK ONLY

STOCK NO.
WTA1250TO



A1150

COVER
Dura-Lon® Synthetic Leather

SEAM
Flat

HITS
This ball is NON-HITTABLE

AVAILABLE IN RETAIL PACK ONLY

STOCK NO.
WTA1150T WTA1150WSHRINK



SOFT COMPRESSION BASEBALLS

A sponge center creates a soft compression ball that makes youth play and indoor training more successful.

LEVEL 1: 93% softer than traditional baseballs

LEVEL 5: 85% softer than traditional baseballs

A1217

STOCK NO.
WTA1217B

COVER
Composite Leather

SEAM LEVEL
Flat 1

CENTER
Sponge Center

AVAILABLE IN RETAIL PACK

STOCK NO.
WTA1217T



A1228

STOCK NO.
WTA1228B

COVER
Composite Leather

SEAM LEVEL
Flat 5

CENTER
Sponge Center

AVAILABLE IN RETAIL PACK

STOCK NO.
WTA1228T



PRACTICE BUCKETS

BALL BUCKET WITH LID

STOCK NO.
WTA3948

Holds 4 Dozen Baseballs



A1098 X-OUT
BUCKET COMBO

STOCK NO.
WTA1098 X-OUT

3 Dozen A1010S Balls;
1 A3948 Ball Bucket

A1098 1030
BUCKET COMBO

STOCK NO.
WTA1098 1030

3 Dozen A1030 Balls;
1 A3948 Ball Bucket



CUSTOM LOGOS & SEAMS

The options for game and practice balls are endless with Wilson® custom baseballs and softballs. Hit up your local team dealer or Territory Manager with your logo and seam color choices to place an order.





COMPRESSION CONTROLLED POLYCORE

COMPRESSION CONTROLLED CORK

CORES SOFTBALL

COMPRESSION CONTROLLED POLYCORE:

The most consistent playing softball in the world. Polycore softballs don't break down as quickly, giving you unmatched durability for performance.

COMPRESSION CONTROLLED CORK:

Exclusive to Wilson®, this softball offers the traditional feel you need at the price you want.

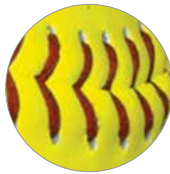

SUPER SEAM TECHNOLOGY™

SEAMS SOFTBALL

SUPER SEAM TECHNOLOGY™:

With seams 20% higher than raised seam baseballs, pitchers experience superior control on the mound. Fielders can locate the ball quickly in their gloves and throw with more accuracy.

COLLEGIATE AND HIGH SCHOOL

A9010

STOCK NO.
WTA9010BSST: 12"

COVER
Leather
Freq. Matched Optic Yellow™

SEAM	STITCH	COR	COMP.
Flat	Red	.47	400 lbs.

CENTER
Compression Controlled Polycore



A9011

STOCK NO.
WTA9011BSST: 12"

COVER
Leather
Freq. Matched Optic Yellow™

SEAM	STITCH	COR	COMP.
SST	Red	.47	375 lbs.

CENTER
Compression Controlled Polycore



NFHS®

A9016

STOCK NO.
WTA9016BSST: 12"

COVER
Leather
Freq. Matched Optic Yellow™

SEAM	STITCH	COR	COMP.
SST	Red	.47	375 lbs.

CENTER
Compression Controlled Cork



NFHS®

A9244

STOCK NO.
WTA9244BNFHSYR: 11"

COVER
Leather
Freq. Matched Optic Yellow™

SEAM	STITCH	COR	COMP.
Flat	Red	.44	375 lbs.

CENTER
Compression Controlled Polycore



NFHS®

USA

USA SOFTBALL®

STOCK NO.

WTA9031BASA-LOW: 12"
WTA9231BASA-LOW: 11"

COVER

Leather
Freq. Matched Optic Yellow™

SEAM	STITCH	COR	COMP.
SST	Red	.47	375 lbs.

CENTER

Compression Controlled Polycore

STOCK NO.

WTA9131BASA-LOW: 12"
WTA9331BASA-LOW: 11"

COVER

Synthetic Leather
Freq. Matched Optic Yellow™

SEAM	STITCH	COR	COMP.
SST	Red	.47	375 lbs.

AVAILABLE IN RETAIL PACK

STOCK NO.

WTA9031TASA-LOW



USA SOFTBALL®

STOCK NO.

WTA9060BASA-LOW: 12"
WTA9260BASA-LOW: 11"

COVER

Leather
Freq. Matched Optic Yellow™

SEAM	STITCH	COR	COMP.
SST	Red	.47	375 lbs.

CENTER

Compression Controlled Cork

STOCK NO.

WTA9106BASA-LOW: 12"
WTA9306BASA-LOW: 11"

COVER

Synthetic Leather
Freq. Matched Optic Yellow™

SEAM	STITCH	COR	COMP.
SST	Red	.47	300 lbs.

AVAILABLE IN RETAIL PACK

STOCK NO.

WTA9106TASA-LOW WTA9306TASA-LOW



USSSA®

USA SERIES

STOCK NO.

WTA9033BUSSFPYB: 12"
WTA9233BUSSFPYB: 11"

COVER

Leather
Freq. Matched Optic Yellow™

SEAM	STITCH	COR	COMP.
SST	Blue	.47	375 lbs.

CENTER

Compression Controlled Polycore



USA SERIES®

STOCK NO.

WTA9133BUSSFPYB: 12"
WTA9333BUSSFPYB: 11"

COVER

Synthetic Leather
Freq. Matched Optic Yellow™

SEAM	STITCH	COR	COMP.
SST	Blue	.47	375 lbs.

CENTER

Compression Controlled Polycore





YOUTH LEAGUE

LITTLE LEAGUE®

STOCK NO.
WTA9074BSST: 12"
WTA9274BSST: 11"

COVER
Leather
Freq. Matched Optic Yellow™

SEAM	STITCH	COR.	COMP.
SST	Red	.47	375 lbs.

CENTER
Compression Controlled Polycore



Little League.

PONY® LEAGUE

STOCK NO.
WTA9075BSST: 12"
WTA9275BSST: 11"

COVER
Leather
Freq. Matched Optic Yellow™

SEAM	STITCH	COR.	COMP.
SST	Red	.47	375 lbs.

CENTER
Compression Controlled Polycore



TRAINING

RECREATIONAL

STOCK NO.
WTA9150T: 12"

COVER
Synthetic Leather
Freq. Matched Optic Yellow™

SEAM	STITCH
Flat	Red

CENTER
Compression Controlled Cork

STOCK NO.
WTA9250TO: 11"

COVER
Synthetic Leather
Freq. Matched Optic Yellow™

SEAM	STITCH
Flat	Red

CENTER
Compression Controlled Cork



SOFT COMPRESSION

STOCK NO.
WTA9117B: 12"
WTA9317B: 11"

COVER
Ultra Grip™
Freq. Matched Optic Yellow™

SEAM	STITCH	LEVEL
SST	Red	1

CENTER
Sponge Center

AVAILABLE IN RETAIL PACK

STOCK NO.
WTA9117T WTA9317T



BALL BUCKET WITH LID

STOCK NO.
WTA394700

Holds 2 Dozen Softballs





USA SOFTBALL®

RAZZO

STOCK NO. WDRZOL11AB: 11"

COVER
LEATHER OPTIC YELLOW™

STITCH COR COMP.
RED .44 375 LBS.

STOCK NO. WDRZOS11AB: 11"

COVER
SYNTH. LEATHER OPTIC YELLOW™



REQUIREMENTS:
.44 COR;
375 LBS. MAX. COMP.

RAZZO +

STOCK NO. WDRZPL12AB: 12"

COVER
LEATHER OPTIC YELLOW™

STITCH COR COMP.
RED .52 300 LBS.

STOCK NO.
WDRZPS12AB: 12"
WDRZPS11AB: 11"

COVER
SYNTH. LEATHER OPTIC YELLOW™



REQUIREMENTS:
.52 COR;
300 LBS. MAX. COMP.

USSSA® SERIES

RAZZO | M

STOCK NO. WDRZML12UB: 12"

COVER
LEATHER OPTIC YELLOW™

STITCH COR COMP.
BLUE .40 325 LBS.

STOCK NO. WDRZMC12UB: 12"

COVER
COMPOSITE OPTIC YELLOW™

STOCK NO. WDRZMS12UB: 12"

COVER
SYNTH. LEATHER OPTIC YELLOW™



USSSA® REQUIREMENTS
MEN'S CLASSIC M: .40 COR;
325 LBS. MAX. COMPRESSION

RAZZO | W

STOCK NO. WDRZWL11UB: 11"

COVER
LEATHER OPTIC YELLOW™

STITCH COR COMP.
BLUE .44 400 LBS.

STOCK NO. WDRZWS11UB: 11"

COVER
SYNTH. LEATHER OPTIC YELLOW™



USSSA® REQUIREMENTS
WOMEN'S CLASSIC W: .44 COR;
400 LBS. MAX. COMPRESSION

RAZZO | Y

STOCK NO. WDRZYL12UB: 12"

COVER
LEATHER OPTIC YELLOW™

STITCH COR COMP.
BLUE .52 300 LBS.

STOCK NO. WDRZYS12UB: 12"

COVER
SYNTH. LEATHER OPTIC YELLOW™



USSSA® REQUIREMENTS:
.52 COR;
300 LBS. MAX. COMPRESSION

NSA® SERIES

STOCK NO. WTA9071BNSA: 12"

COVER
LEATHER OPTIC YELLOW™

STITCH
BLACK

STOCK NO.
WTA9171BNSA: 12"
WTA9371BNSA: 11"

COVER
SYNTH. LEATHER OPTIC YELLOW™



STOCK NO. WTA9471BNSA: 12"

COVER
LEATHER OPTIC YELLOW™

STITCH
BLACK



W

WINDY CITY SERIES

WINDY CITY™

STOCK NO.
WTA9266B: 16"

COVER
Leather

SEAM
Flat

CENTER
Compression Controlled Cork



windy
city



ATEC[®] TRAINING EQUIPEMENT

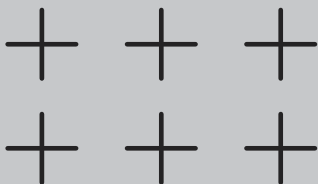

M3X™ THE ONLY MACHINE YOU'LL EVER NEED.

OFFENSE

- High Pitch Speeds: 90+ MPH [BB] and 70+MPH [SB]
- Throws all realistic pitch types
- Mound-to-Plate Pitch Distance
- Gives a realistic release point height
- Offers both LHP and RHP pitch types
- Compatible with any type of ball



DEFENSE

- Top-Spin Ground Balls
- Full-Field Fungo: 350+ FT. [BB] and 240+ FT. [SB] Fly Balls
- Hooking & Slicing Line Drives
- Catcher's Pop Ups



PORTABLE & VERSATILE

- Heavy Duty Wheels
- 3 Base Options
- Easy Conversion between Baseball & Softball
 - [No Additional Parts Needed]



M3X™

CLASS: **OFFENSIVE & DEFENSIVE TRAINING MACHINE**
LEVEL: **PROFESSIONAL**



The revolutionary M3X training machine is the first all-in-one crossover pitching machine of its kind. Designed as a smaller, more portable 3-wheel machine, the M3X contains all the power of full-sized 3-wheel machines, while combining the same features of the defensive R-Series machines by ATEC.

The all-in-one M3X crossover machine is also able to be converted to a fastpitch softball machine. By moving the motor placements to the outside settings, the M3X can go from throwing baseballs to softballs in a matter of minutes.

Offensive Pitching: By utilizing three wheels, top speed, accuracy and spin are maximized due to the ball's increased surface contact with the wheels. The M3X is equipped to throw in excess of 90 MPH, giving you the ability to train against Major League-quality fastballs and both right and left-handed breaking balls. Using only the speed control knobs, pitches can easily be dialed-in without making any physical adjustments to the machine, helping you improve the efficiency and effectiveness of your batting practice.

Defensive Training: Combining the functionality of the R-Series machines also give the M3X the ability to swivel 360 degrees, and control elevation from ground balls and fly balls in a split second. This gives the user the ability to execute hundreds of ground balls, line drives, fly balls and pop-ups in a single practice, giving your players more quality repetitions than could possibly be achieved with only a fungo bat.

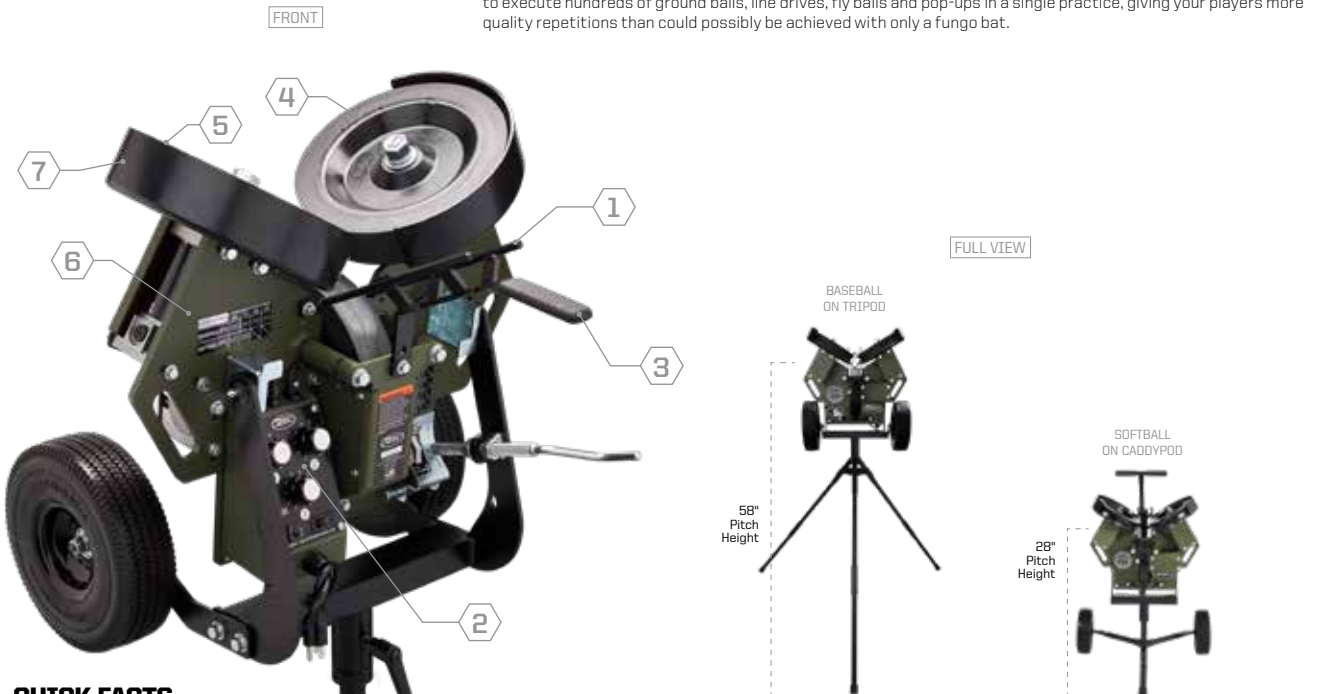

QUICK FACTS

TOP SPEED

90+
MPH

PITCHES THROWN



COMPATIBLE BALL TYPES

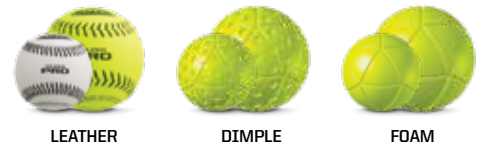

PRODUCT FEATURES

- High Definition Ball Chute**
 - With an uninterrupted view of the ball for a Live-Arm sense of timing
- Speed Control Dials**
 - To quickly change between fastballs, off-speed pitches and breaking balls
- Full Control Fungo System (FCFS)**
 - Maximizes your defensive ball placement and control
- Concave Wheel Treads**
 - Increase ball grip and maximize pitch accuracy
- Dual Durometer Wheel Hubs**
 - Increase maximum pitch speed and minimize recovery time
- Durable Steel Frame**
 - And wide base tripod absorb machine recoil for maximum accuracy
- ABS Wheel Guards**
 - Help protect the operator and the machine wheels
- Ball Compatibility**
 - Regulation leather balls, rubber dimple, and foam machine baseballs and softballs

PRODUCT SPECS.

SPORT	STOCK NO.	BASE	MSRP
BB	WTATMM3BTX	Tripod	\$2,999.95
SB	WTATMM3SCX	CaddyPod	\$2,999.95

	Baseball-M3BTX	Softball-M3SCX
Ball Size	Baseball: 9"	Softball: 11", 12"
Ball Types	Leather, Dimple & Foam	Leather, Dimple & Foam
Speed Range	30-90+ MPH	30-75+ MPH
Max Fly Ball Dist.	340+ FT	240+ FT
Pitch Height	58 IN	28 IN
Base Type	Tripod	CaddyPod
Footprint	1260 IN ²	900 IN ²
Weight	115 LBS	115 LBS
Power Supply	110v AC	110v AC
Generator Use	1800w CD	1800w CD



M1.J™

CLASS: **OFFENSIVE PITCHING MACHINE**
LEVEL: **TRAVEL**



The all new M1.J is the fastball only version of the only version of previous ATEC single-wheel machines. This machine is great for younger age groups and machine pitch leagues, with its lightweight portability and easy setup. With speeds of 30-70 MPH, this will allow the machine user to throw a straight fastball to match any player's abilities. It's built using the same technology, processes and materials as ATEC's other industry leading training machines. Similar to other high-end ATEC® machines, the M1.J is also equipped with a dual-durometer concave wheel. This wheel is engineered to increase the wheel's grip on the ball which maximize both pitch speed and accuracy. The M1.J also features a tilting throwing head, which allows the machine to throw ground balls and fly balls. This machine is the perfect addition for any team looking to improve all areas of their game!



QUICK FACTS

TOP SPEED

90 MPH

PITCHES THROWN



COMPATIBLE BALL TYPES



LEATHER



DIMPLE



FOAM

PRODUCT FEATURES

- 1. Concave Wheel Tread**
 - Increases ball grip to maximize pitch speed and accuracy
- 2. Dual-Durometer Wheel Hub**
 - Faster acceleration than other wheels, increasing maximum pitch speed and minimizing recovery time
- 3. Durable Steel Frame**
 - Rugged steel frame and wide base tripod absorb machine recoil ensuring maximum accuracy every pitch
- 4. Metal Ball Chute**
 - Durable metal construction extends life of use
- 5. Real Ball Compatibility**
 - Compatible for use with regulation leather baseballs as well as dimple and foam machine baseballs

PRODUCT SPECS.

SPORT	STOCK NO.	BASE	MSRP
BB	WTATMM1BTJ	Tripod	\$1,499.95
SB	WTATMM1SLJ	Lowpod	\$1,499.95

	Baseball—M1BT	Softball—M1SL
Ball Size	Baseball: 9"	Softball: 11", 12"
Ball Types	Leather, Dimple & Foam	Leather, Dimple & Foam
Speed Range	30-70 MPH	30-70 MPH
Max Fly Ball Dist.	8 SEC	8 SEC
Pitch Height	62 IN	25 IN
Base Type	Tripod	Lowpod
Footprint	1260 IN ²	340 IN ²
Weight	60 LBS	48 LBS
Power Supply	110v AC	110v AC
Generator Use	600w CD	600w CD

R2™

CLASS: **DEFENSIVE TRAINING MACHINE**
LEVEL: **COLLEGIATE**

AUTHENTIC COLLECTION

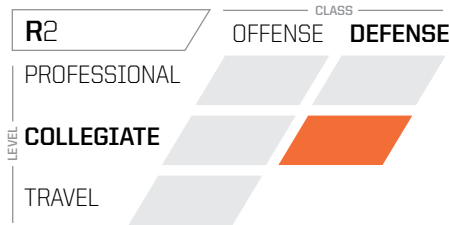

The R2, formerly called the Rookie, is built for collegiate level defensive training. It is designed to be a more compact professional grade training machine. The R2 has the unique ability to rotate and pivot freely while the machine is on and in use, allowing you to challenge multiple fielders, playing different positions, one after another. This machine also allows you to achieve the maximum number of repetitions for any defensive drill; giving your players more quality repetitions than could possibly be achieved with only a fungo bat.



QUICK FACTS

TOP SPEED

75
MPH

MAXIMUM FLY BALL

300
FT

RECOVERY TIME

7
SEC

WEIGHT

70
LBS

COMPATIBLE BALL TYPES



LEATHER



DIMPLE



FOAM

PRODUCT FEATURES

- 1. Full Control Fungo System (FCFS)**
 - Maximizes your ability to control exactly where the ball is placed during defensive drills
 - Change the ball placement of each rep, or keep it locked in to maximize repetitions of a single type
 - 2. Hi.Per™ Aluminum Discs**
 - Allows the machine to achieve the lowest recovery time possible
 - Engineered to be extremely lightweight and durable
 - 3. High Definition Ball Chute**
 - Players have a clear and uninterrupted view of the ball throughout the entire cycle
 - 4. Caddy pod**
 - Industry leading wheeled transport system makes set up and transitioning between drills quick and simple
 - 5. Durable Steel Frame**
 - Rugged frame and caddy pod absorb machine recoil ensuring maximum accuracy of every pitch
- Real Ball Compatibility**
- Compatible for use with leather balls as well as dimpled and foam machine balls

PRODUCT SPECS.

SPORT	STOCK NO.	BASE	MSRP
BB	WTATMR2BC	Caddy pod	\$2,499.95
SB	WTATMR2SC	Caddy pod	\$2,499.95

	Baseball - R2BC	Softball - M3SCX
Ball Size	Baseball: 9"	Softball: 11", 12"
Ball Types	Leather, Dimple & Foam	Leather, Dimple & Foam
Speed Range	75 MPH	70 MPH
Max Fly Ball Dist.	7 SEC	7 SEC
Pitch Height	20 IN	20 IN
Base Type	Caddy pod	Caddy pod
Footprint	900 IN ²	900 IN ²
Weight	70 LBS	70 LBS
Power Supply	110v AC	110v AC
Generator Use	600w CD	600w CD



BUCKET FEEDER



The Bucket Feeder is designed for use with any current ATEC® machine, as well as many older generation models. Compatible with a five or six gallon bucket, the Bucket Feeder is designed to reduce time spent between shagging balls and resuming the current training session. Perfect for coaches looking for a hands off approach for machine operation, allowing better focus on player development; or players looking for a solo training solution.



QUICK FACTS

FEEDER RELOAD TIME

30
SEC

MAX BALL CAPACITY

60
BASEBALLS

PITCH INTERVAL

8
SEC

COMPATIBLE BALL TYPES



LEATHER



DIMPLE



FOAM

PRODUCT FEATURES

1. Easy Load Design

- Pivoting Head allows for upright bucket loading
- Reload Feeder with new bucket in under 30 seconds

2. Compatible with five or six gallon buckets

- Five Gallon = 48 Baseballs
- Six Gallon = 60 Baseballs

Compatible with the following ATEC machines:

- M3X™, M3™, M1.J™, M2™, M1™
- R2™ (on Tripod)
- Casey Pro 3G, Casey Pro
- Power Hummer, Rookie
- Axis, Radius

PRODUCT SPECS.

SPORT	STOCK NO.	BASE	MSRP
BB	WTATAMFBK	Bucket Feeder	\$999.99
SB	WBA742501	Bucket Feeder	\$999.99

COMES WITH

BALL BUCKET

- BB Capacity: 4 DZ
- SB Capacity: 2 DZ



TRAINING BASEBALLS



Machines are only one part of what creates consistent and accurate ball flight. The balls you choose to use with your machine are the second most important factor in your training machine's accuracy, and account for roughly 30% of the accuracy equation. Our High Performance (Hi.Per®) ball line is built with numerous proprietary aerodynamic designs that maximize your training machine's accuracy. Each ball within the Hi.Per lineup is the most advanced ball in its class, helping you achieve the most consistent and accurate ball flight every time.



Hi.Per® Pro—Leather Flat Seam Ball

(Built for Real Ball Training)

Regulation Size & Weight • Premium Full Grain Leather Cover • High-Tensile Strength AccuSeams made from Heavy-Duty Kevlar • Red Cushion Cork Center (Baseball) • Polycore Center Max. 44 CDR (Softball) • Safe for use with Performance Bats • Approved for Indoor & Outdoor Training

BASEBALL		MSRP
WTATBLO1B12	1 Dozen	\$74.99



Hi.Per® X-ACT—Dimple Ball

(Built for Maximum Machine Accuracy)

Regulation Size & Weight • Sting Blocking Construction • Xtream Aerodynamic Technology (X-ACT) Surface Design Maximizes Training Machine Accuracy • Safe for use with Performance Bats • Approved for Indoor & Outdoor Training

BASEBALL		MSRP
WTATBDO2B12	1 Dozen	\$54.99



Hi.Per® Lite—Foam Ball

(Built for High Repetition Training)

Regulation Size • ~30% Regulation Weight • Durable High-Density Foam Construction • Aerodynamically Optimized Surface Design Maximizes Training Machine Accuracy • Safe for use with Performance Bats • Approved for Indoor & Outdoor Training

BASEBALL		MSRP
WTATBFO2B12	1 Dozen	\$54.99



Hi.Per® LTD—Limited Distance Ball

(Built for Limited Space Training)



Regulation Size • Perfect for Pre-Game Warm Up • Maximum Flight Distance of ~100ft • XDC (Xtra Durable Composite) Construction Eliminates Cracking • Proprietary Tactile Surface Texture Increases Grip & Throwing Accuracy • Approved for Indoor & Outdoor Training

BASEBALL		MSRP
WTATBPQ2B12	1 Dozen (Sold in Retail Packaging)	\$54.99

Buckets



Ball Bucket

Baseball Capacity: 4 DZ

Closed-Cell Foam Cushioned Lid • Durable Padded Handle • Semitransparent Color • 5 Gallon Volume

Cage Bucket

Baseball Capacity: 8 DZ

Rugged Built-In Handles for Maximum Durability • White Color • Includes Lid • 9.5 Gallon Volume

BASEBALL		MSRP
WTATABBK	Ball Bucket	\$24.99
WTATACBK	Cage Bucket	\$59.99



TRAINING SOFTBALLS

Machines are only one part of what creates consistent and accurate ball flight. The balls you choose to use with your machine are the second most important factor in your training machine's accuracy, and account for roughly 30% of the accuracy equation. Our High Performance (Hi.Per®) ball line is built with numerous proprietary aerodynamic designs that maximize your training machine's accuracy. Each ball within the Hi.Per lineup is the most advanced ball in its class, helping you achieve the most consistent and accurate ball flight every time.



Hi.Per® Pro—Leather Flat Seam Ball

(Built for Real Ball Training)

Regulation Size & Weight • Premium Full Grain Leather Cover • High-Tensile Strength AccuSeams made from Heavy-Duty Kevlar • Red Cushion Cork Center (Baseball) • Polycore Center Max. 44 COR (Softball) • Safe for use with Performance Bats • Approved for Indoor & Outdoor Training

SOFTBALL (12")		MSRP
WTATBL02S12	1 Dozen	\$119.99



Hi.Per® X-ACT—Dimple Ball

(Built for Maximum Machine Accuracy)

Regulation Size & Weight • Sting Blocking Construction • Xtream Aerodynamic Technology (X-ACT) Surface Design Maximizes Training Machine Accuracy • Safe for use with Performance Bats • Approved for Indoor & Outdoor Training

SOFTBALL (12")		MSRP
WTATBD02S12	1 Dozen	\$64.99



Hi.Per® Lite—Foam Ball

(Built for High Repetition Training)

Regulation Size • ~30% Regulation Weight • Durable High-Density Foam Construction • Aerodynamically Optimized Surface Design Maximizes Training Machine Accuracy • Safe for use with Performance Bats • Approved for Indoor & Outdoor Training

SOFTBALL (12")		MSRP
WTATBF02S12	1 Dozen	\$54.99



Buckets

Ball Bucket

Softball Capacity: **2 DZ**
Closed-Cell Foam Cushioned Lid • Durable Padded Handle • Semitransparent Color • 5 Gallon Volume

Cage Bucket

Softball Capacity: **3 DZ**
Rugged Built-In Handles for Maximum Durability • White Color • Includes Lid • 9.5 Gallon Volume

SOFTBALL		MSRP
WTATABBKT	Ball Bucket	\$24.99
WTATACBKT	Cage Bucket	\$59.99

PRO BATTING TEES



T3,™ T3 WEIGHTED & T3 SHORTY: Players use batting tees every, single, day. It is the most important piece of training equipment and our T3 tees are a staple in every Major League batting tunnel. The T3 is precisely engineered and built with industry leading materials to minimize swing interference and maximize positive contact zone feedback. The T3 lineup is designed to exceed the expectations of MLB® players and coaches. Our professional tees come with a full 1-year warranty and can quickly be set up and taken down for maximum portability.



QUICK FACTS

	MAXIMUM HEIGHT	MINIMUM HEIGHT		MAXIMUM HEIGHT	MINIMUM HEIGHT	
T3	43 IN	23 IN		22 IN	16 IN	T3s

PRODUCT FEATURES

- Hi.Per™ Composite Cone**
 - Helically-wrapped proprietary high performance composite minimizes swing interference and maximizes durability
 - Minimal swing interference provides optimal feedback to the hitter on every swing
- CNC Aluminum Stem**
 - Precision-milled and weather resistant aluminum maximizes performance and durability
 - Patented internal construction creates maximum friction between tiers allowing the height of the tee to remain consistent after every swing
 - Ball height can quickly be adjusted enabling the hitter to practice their mechanics on pitch heights throughout the strike zone
- High Density Base**
 - T3 Weighted Tee comes standard with 8 lb. urethane base to increase tee stability and durability. Includes carrying handle in tee base for easy transport.
 - T3 & T3s come with 2 lb. high density material base for lightweight portability
 - All T3 tee options easily detach stem and base for maximum portability

PRODUCT SPECS.

SPORT	STOCK NO.	MSRP
WTATT3000	T3*	\$119.95
WTATT3W00	T3 Weighted	\$129.95
WTATT3S00	T3s	\$99.95
WTATT3ORP	T3 Cone Replacement	\$34.99

T3 PROFESSIONAL BATTING TEES

- Supplied to all 30 Major League Teams

*Sold in Eco-Friendly Retail Packaging

PRACTICE SCREENS

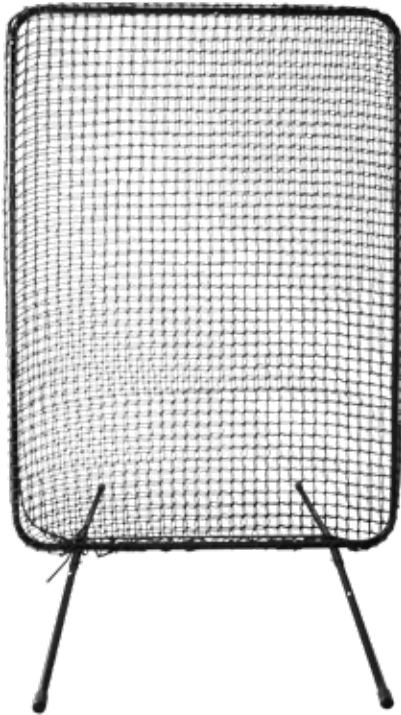

NEW CAGE SCREEN

ARTICLE NO.	PRODUCT	MSRP
WBA743101	Cage Screen	\$249.99

Durable steel frame with powder-coated finish • Heavy duty nylon screen

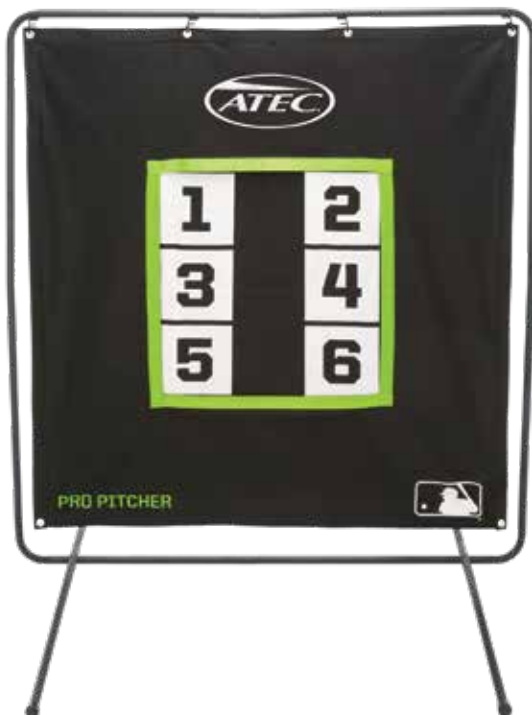

PRO PITCHER

STOCK NO.	PRODUCT	MSRP
WTATNPP00	Pro Pitcher (Sold in retail packaging)	\$149.99
WTATPP00P1	Replacement Screen (Screen Only)	\$79.99

Highly visible numbered targets • Increases pitcher's focus and location discipline • Built-in strike zone collection pocket • Heavy duty nylon screen • Steel frame with powder-coated finish • 1 year limited warranty

ACCESSORIES & PARTS



MACHINE COVER

STOCK NO.	MSRP
WTATAMUCR	\$69.99

Durable water-resistant nylon with drawstring cord • Helps protect machine from the elements • Fits all ATEC Training Machines



TRIPOD BUCKET HOLDER CLIP

STOCK NO.	WEIGHT	MSRP
WTATABKTHDR	1 LB.	\$14.99

Compatible with any ATEC Baseball Tripod • Attach the bucket holder easily by sliding it over two of the tripod legs, allowing the machine user to easily hang any type of ball bucket with a handle from the machine • Compatible with any bucket with a handle • Included with all new M-Series Baseball machines



CADDYPOD (SIMULATES BATTED BALL HEIGHT)

STOCK NO.	PRODUCT	WEIGHT	FOOTPRINT	MSRP
WTATAMBCP	CaddyPod	25 LBS.	900 IN ²	\$499.99

Simulates batted ball height • Built in wheels allow for easy transportation and storage • Included with all new R-Series baseball and softball machines • Can be used with any M-Series or R-Series machine • Ships with M3X Softball Machines

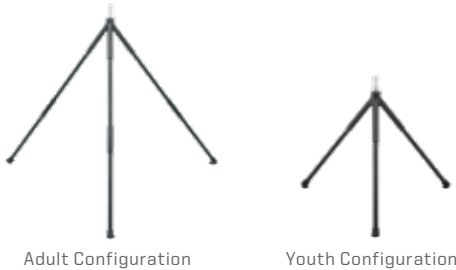

TRIPOD (SIMULATES BASEBALL PITCHER RELEASE HEIGHT)

STOCK NO.	WEIGHT	FOOTPRINT	MSRP
WTATAMBTP	30 LBS.	1260 IN ²	\$399.99

Simulates baseball pitcher's release point • Included with all new M-Series baseball machines • Can be configured to achieve either an adult or youth pitch height • Can be used with any M-Series or R-Series machine • Included with all-new M-Series baseball machines, including the M3X BT model



LOWPOD (SIMULATES SOFTBALL PITCHER RELEASE HEIGHT)

STOCK NO.	WEIGHT	FOOTPRINT	MSRP
WTATAMBLP	10 LBS.	340 IN ²	\$199.99

Simulates softball pitcher's release point • Included with M1J Softball Machine • Can be used with any M-Series or R-Series machine

FOR ALL MACHINE REPLACEMENT PARTS CALL: 1.800.755.5100



BASEBALL STOCK UNIFORMS

2023

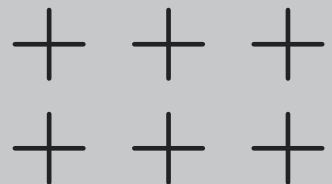

BASEBALL STOCK JERSEY GALLERY



E304 [p.27]



E203 [p.26]



PRO TEAM 2.0 [p.26]



E306 [p.27]



PRO TEAM [p.26]



E304 [p.27]



PRO TEAM 2.0 [p.26]



PRO TEAM [p.26]



E203 [p.26]



E306 [p.27]



E304 [p.27]



PRO TEAM [p.26]



E203 [p.26]



E306 [p.27]



PRO TEAM 2.0 [p.26]

EVOSHIELD®

E203 2-Button Jersey

Shown With:

- WTL4964: 3-color custom screen transfer lettering
- WTL4925: 2-color Vortex screen transfer numeral on front and back

PRICE AS SHOWN
\$60⁹⁹

Available Decoration:

- Screen Transfer
- Film Transfer



JERSEY FEATURES:

- 100% Polyester Pin Dot Mesh
- Relaxed fit
- Contrasting shoulder and neck inserts
- Lightweight moisture wicking fabric

MEN'S SIZES
S-2X

YOUTH SIZES
S-L

MEN	MSRP	YOUTH	MSRP
WTV1220	\$29 ⁹⁹	WTV2220	\$26 ⁹⁹



Fit: Relaxed

Model Measurements:

Ht: 6ft 1"

Chest: 41"

Waist: 32"

Wearing Size Medium



EVOSHIELD®

Pro Team Training Tee 2.0

Shown With:

- WTL4964: 3-color custom screen transfer lettering
- WTL4925: 2-color NCAA® screen numeral on front and back

PRICE AS SHOWN
\$65⁹⁹

Available Decoration:

- Screen Transfer
- Film Transfer



JERSEY FEATURES:

- 92% Polyester / 8% Spandex
- Athletic fit
- Raglan sleeves for maximum mobility and comfort
- No-chafe seams
- Open knit construction for breathability
- Can be worn as a jersey or workout shirt
- Moisture wicking

MEN'S SIZES
S-3X

YOUTH SIZES
S-L

MEN	MSRP	YOUTH	MSRP
WB60046	\$34 ⁹⁹	WB60047	\$29 ⁹⁹



Fit: Athletic

Model Measurements:

Ht: 6ft 1"

Chest: 41"

Waist: 32"

Wearing Size Medium

EVOSHIELD®

Pro Team Training Tee

Shown With:

- WTL4954: 2-color custom screen transfer lettering
- WTL4921: 1-color Plain Block screen transfer numeral on front and back

PRICE AS SHOWN
\$62⁹⁹

Available Decoration:

- Screen Transfer
- Film Transfer



JERSEY FEATURES:

- 94% Polyester / 6% Spandex
- Athletic fit
- Raglan short sleeve construction maximizes player's range of motion
- Mesh back improves air flow
- Can be worn as a jersey, workout shirt, or under a jersey
- Lightweight moisture wicking antimicrobial fabric

MEN'S SIZES
S-3X

YOUTH SIZES
S-L

MEN	MSRP	YOUTH	MSRP
WTV9701	\$34 ⁹⁹	WTV9801	\$29 ⁹⁹



Fit: Athletic

Model Measurements:

Ht: 5ft 11"

Chest: 37"

Waist: 31"

Wearing Size Small

EVOSHIELD®

E304
Performance
Pullover
Heather
Tech Tee™

Shown With:

- WTL4954: 2-color custom screen transfer lettering
- WTL4925: 2-color NCAA® screen transfer numeral on front and back

PRICE AS SHOWN
\$54⁹⁹

- Available Decoration:
- Screen Transfer
 - Film Transfer



JERSEY FEATURES:

- 100% Polyester Interlock
- Athletic fit
- Crew neck construction
- Can be worn as a jersey, workout shirt, or under a jersey
- Lightweight moisture wicking antimicrobial fabric

ADULT SIZES
S-3X | YOUTH SIZES
S-L

ADULT	MSRP	YOUTH	MSRP
WTV1108	\$24 ⁹⁹	WTV2108	\$23 ⁹⁹



Fit: Athletic

Model Measurements:

Ht: 6ft 1"

Chest: 41"

Waist: 32"

Wearing Size Medium



EVOSHIELD®

E306
Performance
Pullover
Tech Tee™

Shown With:

- WTL4954: 2-color Script screen transfer lettering
- WTL4925: 2-color Full Block screen transfer numeral on front and back

PRICE AS SHOWN
\$49⁹⁹

- Available Decoration:
- Screen Transfer
 - Film Transfer



JERSEY FEATURES:

- 100% Polyester Interlock
- Athletic fit, crew neck construction
- Can be worn as a jersey, workout shirt, or under a jersey
- Lightweight moisture wicking fabric

ADULT SIZES
S-3X | YOUTH SIZES
S-L

ADULT	MSRP	YOUTH	MSRP	
WB6003401	\$19. ⁹⁹	WB6003501	\$18. ⁹⁹	BLACK
WB6003402	\$19. ⁹⁹	WB6003502	\$18. ⁹⁹	CARDINAL
WB6003403	\$19. ⁹⁹	WB6003503	\$18. ⁹⁹	CHARCOAL
WB6003404	\$19. ⁹⁹	WB6003504	\$18. ⁹⁹	DARK GREEN
WB6003406	\$19. ⁹⁹	WB6003506	\$18. ⁹⁹	MAROON
WB6003407	\$19. ⁹⁹	WB6003507	\$18. ⁹⁹	NAVY
WB6003408	\$19. ⁹⁹	WB6003508	\$18. ⁹⁹	ORANGE
WB6003409	\$19. ⁹⁹	WB6003509	\$18. ⁹⁹	PINK
WB6003410	\$19. ⁹⁹	WB6003510	\$18. ⁹⁹	PURPLE
WB6003411	\$19. ⁹⁹	WB6003511	\$18. ⁹⁹	ROYAL
WB6003412	\$19. ⁹⁹	WB6003512	\$18. ⁹⁹	SCARLET
WB6003413	\$19. ⁹⁹	WB6003513	\$18. ⁹⁹	TEAM WHITE
WB6003415	\$19. ⁹⁹	WB6003515	\$18. ⁹⁹	TEXAS ORANGE
WB6003416	\$19. ⁹⁹	WB6003516	\$18. ⁹⁹	LIGHT GOLD
WB6003417	\$19. ⁹⁹	WB6003517	\$18. ⁹⁹	VICTORY BLUE



Fit: Athletic

Model Measurements:

Ht: 6ft 1"

Chest: 41"

Waist: 32"

Wearing Size Medium

EVOSHIELD[®] SALUTE[™]

PANT FEATURES:

- 100% polyester double knit (8 oz.)
- Athletic fit
- Hemmed open bottom
- 2 set-in back pockets
- Double layered knees for a longer-lasting pant
- Evoshield[®] elastic gripper waistband improves fit and comfort on the field
- Moisture wicking fabric helps keep you dry and cool

MEN'S SIZES
S-2X

YOUTH SIZES
S-XL



PIPING AVAILABLE \$9⁰⁰



BG [BLUE GREY] TW [TEAM WHITE] BL [BLACK]

ADULT & YOUTH: GRADUATED INSEAMS

COLOR	MEN	MSRP	YOUTH	MSRP
BG	WTV1076BG	\$54 ⁹⁹	WTV2076BG	\$49 ⁹⁹
TW	WTV1076TW	\$54 ⁹⁹	WTV2076TW	\$49 ⁹⁹
BL	WTV107603	\$54 ⁹⁹	WTV207603	\$49 ⁹⁹

ADULT GRADUATED INSEAMS

WTV1076	
SIZE	INSEAM
S	31"
M	32"
L	33"
XL	33"
2X	33"

YOUTH GRADUATED INSEAMS

WTV2076	
SIZE	INSEAM
S	24"
M	26"
L	28"
XL	30"

EVOSHIELD[®] SALUTE[™] KNICKER

PANT FEATURES:

- 100% polyester double knit (8 oz.)
- Athletic fit
- 2 set-in back pockets
- Double layered knees for a longer-lasting pant
- Evoshield[®] elastic gripper waistband improves fit and comfort on the field
- Moisture wicking fabric helps keep you dry and cool

MEN'S SIZES
S-2X

YOUTH SIZES
S-XL



PIPING AVAILABLE \$9⁰⁰



01 [TEAM WHITE] 02 [BLUE GREY] 03 [BLACK]

ADULT & YOUTH: GRADUATED INSEAMS

COLOR	MEN	MSRP	YOUTH	MSRP
TW	WB6000501	\$49 ⁹⁹	WB6000601	\$44 ⁹⁹
BG	WB6000502	\$49 ⁹⁹	WB6000602	\$44 ⁹⁹
BL	WB6000503	\$49 ⁹⁹	WB6000603	\$44 ⁹⁹

ADULT GRADUATED INSEAMS

WB60005	
SIZE	INSEAM
S	16.5"
M	18.5"
L	18.5"
XL	19.5"
2X	19.5"

YOUTH GRADUATED INSEAMS

WB60006	
SIZE	INSEAM
S	12"
M	14"
L	16"
XL	18"

EVOSHIELD[®]
SALUTE™ PINSTRIPE

PANT FEATURES:

- 100% polyester double knit (8 oz.)
- Athletic fit - provides contoured, slim silhouette
- Hemmed open bottom
- 2 set-in back pockets
- Double layered knees for a longer-lasting pant
- Evoshield[®] elastic gripper waistband improves fit and comfort on the field
- Moisture wicking fabric helps keep you dry and cool

MEN'S SIZES | **YOUTH SIZES**
S-2X | **YS-YXL**



01 [TEAM WHITE/BLACK] 02 [TEAM WHITE/NAVY]

**ADULT & YOUTH:
 GRADUATED
 INSEAMS**

COLOR	MEN	MSRP	YOUTH	MSRP
TW/BL	WB6017701	\$59 ⁹⁹	WB6017801	\$54 ⁹⁹
TW/NA	WB6017702	\$59 ⁹⁹	WB6017802	\$54 ⁹⁹

ADULT GRADUATED INSEAMS

SIZE	INSEAM
S	31"
M	32"
L	33"
XL	33"
2X	33"

YOUTH GRADUATED INSEAMS

SIZE	INSEAM
S	24"
M	26"
L	28"
XL	30"

EVOSHIELD[®]
**SALUTE™ PINSTRIPE
 KNICKER**

PANT FEATURES:

- 100% polyester double knit (8 oz.)
- Athletic fit - provides contoured, slim silhouette
- Knicker cut
- 2 set-in back pockets
- Double layered knees for a longer-lasting pant
- Evoshield[®] elastic gripper waistband improves fit and comfort on the field
- Moisture wicking fabric helps keep you dry and cool

MEN'S SIZES | **YOUTH SIZES**
S-2X | **YS-YXL**



01 [TEAM WHITE/BLACK] 02 [TEAM WHITE/NAVY]

**ADULT & YOUTH:
 GRADUATED
 INSEAMS**

COLOR	MEN	MSRP	YOUTH	MSRP
TW/BL	WB6017901	\$54 ⁹⁹	WB6018001	\$49 ⁹⁹
TW/NA	WB6017902	\$54 ⁹⁹	WB6018002	\$49 ⁹⁹

ADULT GRADUATED INSEAMS

SIZE	INSEAM
S	16.5"
M	18.5"
L	18.5"
XL	19.5"
2X	19.5"

YOUTH GRADUATED INSEAMS

SIZE	INSEAM
S	12"
M	14"
L	16"
XL	18"

EVOSHIELD®
PRO-SRZ STRIPED GAME SOCKS

SOCK FEATURES:

- 58% Nylon/28% Polyester/8% Cotton/6% Spandex
- Variegated rib leg
- Graduated compression for a perfect fit
- Spot ankle and Achilles cushioning provide improved comfort
- Deep heel pocket
- Ergonomic sole cushioning and toe cushioning
- Mesh ventilation help keep your feet dry and cool on the field
- Arch support for enhanced comfort

UNISEX	MSRP
WB60105	\$14 ⁹⁹



EVOSHIELD®
GAME SOCKS

SOCK FEATURES:

- 93% Polyester/6% Spandex/1% Nylon over-the-calf knee high
- Extended Achilles cushioning
- Variegated leg rib; accented arch support
- Space-dyed ergonomic cushioning
- Moisture wicking

UNISEX	MSRP
WTV4446	\$10 ⁹⁹



SOCK SIZING

SOCK	SHOE SIZE		
	MEN	WOMEN	KIDS
S	—	4-6	3Y-5Y
M	6-8	6-10	5Y-7Y
L	8-12	10-13	—
XL	12-15	—	—



WILSON®
ELASTIC BELT

BELT FEATURES:

- Adult 1½" wide is one-size-fits-most
- Youth 1" wide fits waist sizes 18-32"
- Minimum order is 6 per style, color

ADULT	MSRP	YOUTH	MSRP
WTA4442	\$7 ⁹⁹	WTA4444	\$6 ⁹⁹





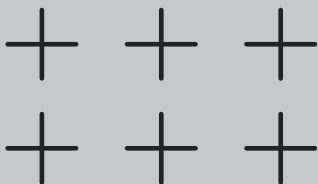

BB TEAM APPAREL

BASEBALL TEAM APPAREL



 @TEAM.SHOP.OFFICIAL

 @TEAM_SHOP_

 @TEAMSHOPOFFICIAL



EVOSHIELD® PRO TEAM TRAINING TEE 2.0

COLOR	ARTICLE	MSRP	ARTICLE	MSRP
Black	WB6004601	\$34.99	WB6004701	\$29.99
Charcoal	WB6004602	\$34.99	WB6004702	\$29.99
Navy	WB6004603	\$34.99	WB6004703	\$29.99
Royal	WB6004604	\$34.99	WB6004704	\$29.99
Scarlet	WB6004605	\$34.99	WB6004705	\$29.99
Team White	WB6004606	\$34.99	WB6004706	\$29.99
SIZES ADULT: S, M, L, XL, 2X, 3X			SIZES YOUTH: YS, YM, YL	

Athletic fit provides contoured, slim silhouette
 Raglan sleeves for maximum mobility and comfort
 No-chafe seams
 Open knit construction for breathability
 Can be used as a workout shirt or jersey
 Moisture-wicking fabric helps keep you dry and cool
 Fabric: 92% Polyester / 8% Spandex
 Decoration: Additional cost

MODEL

FIT Athletic // HEIGHT 6' 1" // CHEST 41" // WAIST 32"
 WEARING SIZE Medium



EVOSHIELD® PRO TEAM LONG SLEEVE TRAINING TEE

ARTICLE	COLOR	MSRP
WB6021601	Black	\$39.99
WB6021602	Charcoal	\$39.99
WB6021603	Navy	\$39.99
WB6021604	Royal	\$39.99
WB6021605	Scarlet	\$39.99
WB6021606	Team White	\$39.99

SIZES ADULT: S, M, L, XL, 2X, 3X

Athletic fit provides contoured, slim silhouette
 Raglan sleeves for maximum mobility and comfort
 No-chafe seams
 Open-knit construction for breathability
 Moisture-wicking fabric helps keep you dry and cool
 Fabric: 92% Polyester / 8% Spandex
 Decoration: Additional cost

MODEL

FIT Athletic // HEIGHT 6' 2" // CHEST 37" // WAIST 32"
 WEARING SIZE Medium



EVOSHIELD® TRAINING TANK

ARTICLE	COLOR	MSRP
WB6013401	Black	\$29.99
WB6013402	Lagoon	\$29.99
WB6013403	Navy	\$29.99
WB6013404	Olive	\$29.99
WB6013405	Royal	\$29.99
WB6013406	Scarlet	\$29.99

SIZES ADULT: S, M, L, XL, 2X, 3X

Athletic fit provides contoured, slim silhouette
 Side vent
 Open-knit construction for breathability
 Moisture-wicking fabric helps keep you dry and cool
 Fabric: 92% Polyester / 8% Spandex
 Decoration: Additional cost

MODEL

FIT Athletic // HEIGHT 6' 2" // CHEST 37" // WAIST 32"
 WEARING SIZE Medium

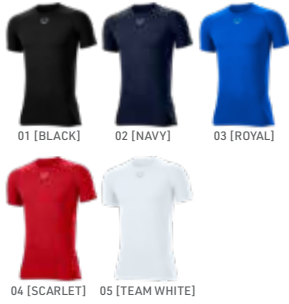

WSL EVOSHIELD® COOLING SHORT SLEEVE

ARTICLE	COLOR	MSRP
WB6014001	Black	\$39.99
WB6014002	Navy	\$39.99
WB6014003	Royal	\$39.99
WB6014004	Scarlet	\$39.99
WB6014005	Team White	\$39.99

SIZES ADULT: S, M, L, XL, 2X, 3X

Fitted design to tightly hug the shape of your body, without restricting movement
 Advanced cooling fabric technology provides a lightweight, cool feel
 UPF rated 50+ for sun protection
 Ergonomic flat seaming
 Moisture-wicking fabric helps keep you dry and cool
 Fabric: 88% Polyester / 12% Spandex
 Decoration: Additional cost

MODEL

FIT Fitted // HEIGHT 5' 11" // CHEST 37" // WAIST 31"
 WEARING SIZE Small



WSL EVOSHIELD® COOLING MID SLEEVE

ARTICLE	COLOR	MSRP
WB6014401	Black	\$44.99
WB6014402	Navy	\$44.99
WB6014403	Royal	\$44.99
WB6014404	Scarlet	\$44.99
WB6014405	Team White	\$44.99

SIZES ADULT: S, M, L, XL, 2X, 3X

Fitted design to tightly hug the shape of your body, without restricting movement
 Advanced cooling fabric technology provides a lightweight, cool feel
 UPF rated 50+ for sun protection
 Ergonomic flat seaming
 Moisture-wicking fabric helps keep you dry and cool
 Fabric: 88% Polyester / 12% Spandex
 Decoration: Additional cost

MODEL

FIT Fitted // HEIGHT 5' 11" // CHEST 37" // WAIST 31"
 WEARING SIZE Small



WSL EVOSHIELD® COOLING LONG SLEEVE

ARTICLE	COLOR	MSRP
WB6014201	Black	\$49.99
WB6014202	Navy	\$49.99
WB6014203	Royal	\$49.99
WB6014204	Scarlet	\$49.99
WB6014205	Team White	\$49.99

SIZES ADULT: S, M, L, XL, 2X, 3X

Fitted design to tightly hug the shape of your body, without restricting movement
 Advanced cooling fabric technology provides a lightweight, cool feel
 UPF rated 50+ for sun protection
 Ergonomic flat seaming
 Moisture-wicking fabric helps keep you dry and cool
 Fabric: 88% Polyester / 12% Spandex
 Decoration additional cost

MODEL

FIT Fitted // HEIGHT 6' 2" // CHEST 37" // WAIST 32"
 WEARING SIZE Medium



EVOSHIELD® PRO TEAM TRAINING TEE

MODEL NO.	SIZES	MSRP
WTV9701	ADULT: S, M, L, XL, 2X, 3X	\$34.99
WTV9801	YOUTH: S, M, L	\$29.99

Athletic fit provides contoured, slim silhouette
 Raglan short sleeve construction maximizes player's range of motion
 Mesh back improves air flow
 Can be worn as a jersey, workout shirt, or under a jersey
 Moisture-wicking fabric helps keep you dry and cool
 Fabric: 94% Polyester / 6% Spandex
 Decoration: Additional cost

MODEL

FIT Athletic // HEIGHT 5' 11" // CHEST 37" // WAIST 31"
 WEARING SIZE Small



EVOSHIELD® WINTER BALL

COLOR	ARTICLE	MSRP	ARTICLE	MSRP
Black	WB6014801	\$49.99	WB6014901	\$44.99
Navy	WB6014802	\$49.99	WB6014902	\$44.99
Royal	WB6014803	\$49.99	WB6014903	\$44.99
Scarlet	WB6014804	\$49.99	WB6014904	\$44.99
		SIZES ADULT: S, M, L, XL, 2X, 3X	SIZES YOUTH: YS, YM, YL	

Mid weight fabric with fleece back
 Fitted design to tightly hug the shape of your body, without restricting movement
 Ventilated underarm panel helps keep you comfortable when working out
 Ventilated back detail
 Fabric: 90% Polyester / 10% Spandex
 Decoration: Additional cost

MODEL

FIT Fitted // HEIGHT 5' 11" // CHEST 37" // WAIST 31"
 WEARING SIZE Small



NEW EVOSHIELD® 365 FLEECE HOODIE

COLOR	ARTICLE	MSRP	ARTICLE	MSRP
Black	WB6015201	\$59.99	WB6015301	\$54.99
Heather Grey	WB6015202	\$59.99	WB6015302	\$54.99
Navy	WB6015203	\$59.99	WB6015303	\$54.99
Royal	WB6015204	\$59.99	WB6015304	\$54.99
Scarlet	WB6015205	\$59.99	WB6015305	\$54.99
Team White	WB6015206	\$59.99	WB6015306	\$54.99
Light Gold	WB6015207	\$59.99	WB6015307	\$54.99
Texas Orange	WB6015208	\$59.99	WB6015308	\$54.99
Victory Blue	WB6015209	\$59.99	WB6015309	\$54.99
		SIZES ADULT: S, M, L, XL, 2X, 3X	SIZES YOUTH: YS, YM, YL	

Kangaroo front pocket
 3-piece hood
 Shoulder and sleeve rib placement allows for unrestricted full range of motion
 2-ply rib cuff and bottom band
 Moisture wicking
 Fabric: 97% Recycled polyester / 3% Spandex
 Fabric Heather Grey: 77% Recycled Polyester / 19% Polyester 4% Spandex
 Decoration: Additional cost

MODEL

FIT Relaxed // HEIGHT 5' 11" // CHEST 38" // WAIST 30" // INSEAM 32"
 WEARING SIZE Medium



01 [BLACK] 02 [CHARCOAL] 03 [NAVY]



04 [ROYAL] 05 [SCARLET] 06 [TEAM WHITE]



NEW EVOSHIELD® LIGHTWEIGHT TRAINING HOODIE 2.0

COLOR	ARTICLE	MSRP	ARTICLE	MSRP
Black	WB6028001	\$54.99	WB6028101	\$49.99
Charcoal	WB6028002	\$54.99	WB6028102	\$49.99
Navy	WB6028003	\$54.99	WB6028103	\$49.99
Royal	WB6028004	\$54.99	WB6028104	\$49.99
Scarlet	WB6028005	\$54.99	WB6028105	\$49.99
Team White	WB6028006	\$54.99	WB6028106	\$49.99
SIZES ADULT: S, M, L, XL, 2X, 3X			SIZES YOUTH: YS, YM, YL	

Athletic fit provides contoured, slim silhouette

Textured 4-way stretch material

3-piece hood

Side vents

Moisture wicking

Fabric: 95% Polyester / 5% Spandex

Decoration: Additional cost

MODEL

FIT Athletic // HEIGHT 5' 11" // CHEST 38" // WAIST 30" // INSEAM 32"

WEARING SIZE Medium



01 [BLACK] 02 [CHARCOAL] 03 [NAVY]



04 [TEAM WHITE] 05 [ROYAL] 06 [SCARLET]



Shown with sleeves removed



EVOSHIELD® LONG SLEEVE BP JACKET

ARTICLE	COLOR	MSRP
WB6002201	Black	\$79.99
WB6002202	Charcoal	\$79.99
WB6002203	Navy	\$79.99
WB6002204	Team White	\$79.99
WB6002205	Royal	\$79.99
WB6002206	Scarlet	\$79.99

SIZES ADULT: S, M, L, XL, 2X, 3X

Relaxed fit allows for a totally unrestricted range of motion

Kangaroo front pocket with zip closure

Locking drawcord on bottom hem

1/2 zip with reflective taping

Rear mesh yoke

Reflective exterior locker loop

Breathable mesh side inserts

Removable sleeves; jacket can be worn as long sleeve or short sleeve

Fabric: 94% Polyester / 6% Spandex

Decoration: Additional cost

MODEL

FIT Relaxed // HEIGHT 6' 2" // CHEST 37" // WAIST 32"

WEARING SIZE Medium



01 [BLACK] 02 [CHARCOAL] 03 [NAVY]



04 [ROYAL] 05 [SCARLET] 06 [TEAM WHITE]



NEW EVOSHIELD® IMPAK SHORT SLEEVE BP JACKET

COLOR	ARTICLE	MSRP	ARTICLE	MSRP
Black	WB6028501	\$59.99	WB6028601	\$54.99
Charcoal	WB6028502	\$59.99	WB6028602	\$54.99
Navy	WB6028503	\$59.99	WB6028603	\$54.99
Royal	WB6028504	\$59.99	WB6028604	\$54.99
Scarlet	WB6028505	\$59.99	WB6028605	\$54.99
Team White	WB6028506	\$59.99	WB6028606	\$54.99
SIZES ADULT: S, M, L, XL, 2X, 3X			SIZES YOUTH: YS, YM, YL	

Relaxed fit allows for totally unrestricted range of motion

Angled self snap placket neck line

Invisible zippered kangaroo pocket

Back mesh yoke under wind flap

Locking drawcord in the bottom hem to adjust fit

Moisture wicking

Fabric: 94% Polyester / 6% Spandex

Decoration: Additional cost

MODEL

FIT Relaxed // HEIGHT 5'11" // CHEST 38" // WAIST 30" // INSEAM 32"

WEARING SIZE Small



01 [BLACK] 02 [CHARCOAL] 03 [NAVY]



04 [ROYAL] 05 [SCARLET]



EVOSHIELD® PRO TEAM HEATER FLEECE

NEW YOUTH SIZES (EARLY 2023 ARRIVAL)

COLOR	ARTICLE	MSRP	ARTICLE	MSRP
Black	WB6016101	\$59.99	WB6032601	\$54.99
Charcoal	WB6016102	\$59.99	WB6032602	\$54.99
Navy	WB6016103	\$59.99	WB6032603	\$54.99
Royal	WB6016104	\$59.99		
Scarlet	WB6016105	\$59.99		
SIZES ADULT: S, M, L, XL, 2X, 3X			SIZES YOUTH: S, M, L	

Relaxed fit allows for a totally unrestricted range of motion

Concealed kangaroo pocket

Rib cuff, collar and hem

Fabric: 95% Polyester / 5% Spandex

Decoration: Additional cost

MODEL

FIT Relaxed // HEIGHT 6'2" // CHEST 37" // WAIST 32"

WEARING SIZE Medium



EVOSHIELD® PRO TEAM SHORT 2.0

COLOR	ARTICLE	MSRP	ARTICLE	MSRP
Black	WB6005501	\$34.99	WB6005601	\$29.99
Charcoal	WB6005502	\$34.99	WB6005602	\$29.99
Navy	WB6005503	\$34.99	WB6005603	\$29.99
Royal	WB6005504	\$34.99	WB6005604	\$29.99
Scarlet	WB6005505	\$34.99	WB6005605	\$29.99
Light Gold	WB6005508	\$34.99	WB6005608	\$29.99
Texas Orange	WB6005512	\$34.99	WB6005612	\$29.99
Victory Blue	WB6005513	\$34.99	WB6005613	\$29.99
SIZES ADULT: S, M, L, XL, 2X, 3X			SIZES YOUTH: YS, YM, YL	

Designed for player workouts and practice
 Push Evoshield waistband w/adjustable drawcord
 7½" inseam
 2 side pockets
 Side vent for breathability
 Fabric: 100% Polyester
 Decoration: Additional cost

MODEL

FIT Athletic // HEIGHT 6' 1" // WAIST 32"
 WEARING SIZE Medium



NEW EVOSHIELD® GAME CHANGING 2 IN 1 SHORT

ARTICLE	COLOR	MSRP
WB6028201	Black	\$54.99
WB6028202	Charcoal	\$54.99
WB6028203	Navy	\$54.99
WB6028204	Royal	\$54.99
WB6028205	Scarlet	\$54.99

SIZES ADULT: S, M, L, XL, 2X, 3X

Light stretch woven fabric for unrestricted range of motion
 Athletic fit designed for player workouts and practice
 Encased elastic waistband with internal drawcord
 Built in knit compression short
 2 invisible side zipper pockets
 Fabric: 88% Nylon / 12% Spandex
 Decoration: Additional cost

MODEL

FIT Athletic // HEIGHT 5' 11" // WAIST 30" // INSEAM 32"
 WEARING SIZE Medium

SIZE	INSEAM
S	7"
M	7"
L	7.5"
XL	7.5"
2X	8"
3X	8"



01 [BLACK] 02 [GREY] 03 [NAVY]



WSL EVOSHIELD® PRO TEAM SHORT SLEEVE HOODIE

COLOR	ARTICLE	MSRP	ARTICLE	MSRP
Black	WB6001601	\$74.99	WB6004801	\$69.99
Grey	WB6001602	\$74.99	WB6004802	\$69.99
Navy	WB6001603	\$74.99	WB6004803	\$69.99
SIZES ADULT: S, M, L, XL, 2X, 3X			SIZES YOUTH: YS, YM, YL	

Relaxed fit allows for a totally unrestricted range of motion

Front zippered pocket

Kangaroo pocket

3-piece hood with drawcord

4-way stretch

Fabric: 71% Cotton / 25% Polyester / 4% Spandex

Decoration: Additional cost

MODEL

FIT Relaxed // HEIGHT 6' 1" // CHEST 41" // WAIST 32"

WEARING SIZE Medium



01 [GREY/BLACK] 02 [GREY/NAVY]



03 [GREY/ROYAL] 04 [GREY/SCARLET]



EVOSHIELD® LIGHTWEIGHT SHORT SLEEVE HOODIE

COLOR	ARTICLE	MSRP	ARTICLE	MSRP
Grey/Black	WB6013801	\$39.99	WB6013901	\$34.99
Grey/Navy	WB6013802	\$39.99	WB6013902	\$34.99
Grey/Royal	WB6013803	\$39.99	WB6013903	\$34.99
Grey/Scarlet	WB6013804	\$39.99	WB6013904	\$34.99
SIZES ADULT: S, M, L, XL, 2X, 3X			SIZES YOUTH: YS, YM, YL	

Athletic fit provides contoured, slim silhouette

Kangaroo pocket

Side vent

Three-piece hood

Fabric: 60% Cotton / 40% Recycled Polyester

Decoration: Additional cost

MODEL

FIT Athletic // HEIGHT 5' 11" // CHEST 37" // WAIST 30"

WEARING SIZE Medium



01 [CHARCOAL] 02 [NAVY]



03 [LIGHT GREY] 04 [TEAM WHITE]



EVOSHIELD® FLAGSHIP POLO

ARTICLE	COLOR	MSRP
WB6002001	Charcoal	\$54.99
WB6002002	Navy	\$54.99
WB6002003	Light Grey	\$54.99
WB6002004	Team White	\$54.99

SIZES ADULT: S, M, L, XL, 2X, 3X

Athletic fit provides contoured, slim silhouette
 Engineered stripe pattern
 Raglan sleeves
 3-button front
 Side vent
 Fabric: 100% Polyester
 Decoration: Additional cost

MODEL

FIT Relaxed // HEIGHT 6'2" // CHEST 37" // WAIST 32"
 WEARING SIZE Medium



01 [CHARCOAL] 02 [NAVY]



03 [TEAM WHITE] 04 [BLACK]



EVOSHIELD® GRANDSTAND POLO

ARTICLE	COLOR	MSRP
WB6002101	Charcoal	\$59.99
WB6002102	Navy	\$59.99
WB6002103	Team White	\$59.99
WB6002104	Black	\$59.99

SIZES ADULT: S, M, L, XL, 2X, 3X

Athletic fit provides contoured, slim silhouette
 Rib collar and cuff
 Raglan sleeves
 3-button front
 Side vent
 Fabric: 55% Cotton / 39% Polyester / 6% Spandex
 Decoration: Additional cost

MODEL

FIT Athletic // HEIGHT 6'2" // CHEST 37" // WAIST 32"
 WEARING SIZE Medium



EVOSHIELD® LIGHTWEIGHT ¼ ZIP

ARTICLE	COLOR	MSRP
WB6007101	Black	\$54.99
WB6007102	Charcoal	\$54.99
WB6007103	Navy	\$54.99
WB6007104	Royal	\$54.99
WB6007105	Scarlet	\$54.99

SIZES ADULT: S, M, L, XL, 2X, 3X

Athletic fit provides contoured, slim silhouette
 Mock neck with ¼ zip
 Fabric: 100% Polyester
 Decoration additional cost

MODEL

FIT Athletic // HEIGHT 6' 2" // CHEST 37" // WAIST 32"
 WEARING SIZE Medium



EVOSHIELD® PST GME SHORT

ARTICLE	COLOR	MSRP
WB6002301	Black	\$59.99
WB6002302	Stone	\$59.99
WB6002303	Charcoal	\$59.99

SIZES ADULT: 30-48

Athletic fit provides contoured, slim silhouette
 2 front pockets
 2 rear pockets
 Additional side zippered pocket to stash essentials
 Zippered fly front
 Elastic waistband with silicone gripper
 8.5" Inseam
 Fabric: 92% Polyester / 8% Spandex
 Decoration: Additional cost

MODEL

FIT Athletic // HEIGHT 6' 2" // WAIST 32"
 WEARING SIZE 32



EVOSHIELD® PST GME PANT

ARTICLE	COLOR	INSEAM	MSRP
WB6019601	Black	30"	\$74.99
WB6019701	Black	32"	\$74.99
WB6019801	Black	34"	\$74.99
WB6019603	Charcoal	30"	\$74.99
WB6019703	Charcoal	32"	\$74.99
WB6019803	Charcoal	34"	\$74.99

SIZES ADULT: 30-40

Athletic fit provides contoured, slim silhouette
 Two front pockets
 Rear back zippered pocket
 Additional side pocket to hide away valuables
 Zippered fly front
 Inner elastic waistband with silicone gripper
 Fabric: 92% Polyester / 8% Spandex

MODEL

FIT Athletic // HEIGHT 6' 2" // WAIST 31"
 WEARING SIZE 30-34



EVOSHIELD® HEATHER SHORT SLEEVE TEE

COLOR	ARTICLE	MSRP	ARTICLE	MSRP
Black	WTV1002BL	\$24.99	WTV2002BL	\$19.99
Cardinal	WTV100201	\$24.99	WTV200201	\$19.99
Charcoal	WTV1002CH	\$24.99	WTV2002CH	\$19.99
Dark Green	WTV1002DG	\$24.99	WTV2002DG	\$19.99
Light Gold	WTV100202	\$24.99	WTV200202	\$19.99
Light Grey	WTV1002GR	\$24.99	WTV2002GR	\$19.99
Maroon	WTV1002MA	\$24.99	WTV2002MA	\$19.99
Navy	WTV1002NA	\$24.99	WTV2002NA	\$19.99
Orange	WTV100205	\$24.99	WTV200205	\$19.99
Purple	WTV1002PR	\$24.99	WTV2002PR	\$19.99
Royal	WTV1002RO	\$24.99	WTV2002RO	\$19.99
Scarlet	WTV1002SC	\$24.99	WTV2002SC	\$19.99
Team White	WTV1002TW	\$24.99	WTV2002TW	\$19.99
Texas Orange	WTV100203	\$24.99	WTV200203	\$19.99
SIZES ADULT: S, M, L, XL, 2X, 3X			SIZES YOUTH: S, M, L	

Athletic fit provides contoured, slim silhouette
 Heathered fabric
 Rib crew neck
 Fabric: 52% Polyester / 48% Cotton Heathered Fabric
 Decoration: Additional cost

MODEL

FIT Athletic // HEIGHT 5'11"
 WEARING SIZE Medium



EVOSHIELD® HEATHER LONG SLEEVE TEE

COLOR	ARTICLE	MSRP	ARTICLE	MSRP
Black	WTV1001BL	\$27.99	WTV2001BL	\$22.99
Charcoal	WTV1001CH	\$27.99	WTV2001CH	\$22.99
Light Grey	WTV1001GR	\$27.99	WTV2001GR	\$22.99
Navy	WTV1001NA	\$27.99	WTV2001NA	\$22.99
Royal	WTV1001RO	\$27.99	WTV2001RO	\$22.99
Scarlet	WTV1001SC	\$27.99	WTV2001SC	\$22.99
Team White	WTV1001TW	\$27.99	WTV2001TW	\$22.99
SIZES ADULT: S, M, L, XL, 2X, 3X			SIZES YOUTH: S, M, L	

Athletic fit provides contoured, slim silhouette
 Heathered fabric
 Rib crew neck
 Fabric: 52% Polyester / 48% Cotton Heathered Fabric
 Decoration: Additional cost

MODEL

FIT Athletic // HEIGHT 6'1" // CHEST 41" // WAIST 32"
 WEARING SIZE Medium



WSL EVOSHIELD® POP COLOR TERRY HOODIE

ARTICLE	COLOR	MSRP
WB6006801	Black (Neon Yellow Pop Color)	\$59.99
WB6006802	Heather Grey (Teal Pop Color)	\$59.99
WB6006803	Navy (Tangerine Pop Color)	\$59.99

SIZES ADULT: S, M, L, XL, 2X, 3X

Relaxed fit allows for a totally unrestricted range of motion
 Rib cuff and hem
 Front kangaroo pocket
 Three-piece hood
 Pop color drawcord and embroidered logo
 Midweight fabric makes this a perfect year-round piece
 Fabric: 95% Cotton / 5% Spandex French Terry
 Decoration: Additional cost

MODEL

FIT Athletic // HEIGHT 6' 2" // CHEST 37" // WAIST 32"
 WEARING SIZE Medium



WSL EVOSHIELD® POP COLOR TERRY JOGGER

ARTICLE	COLOR	MSRP
WB6006901	Black (Neon Yellow Pop Color)	\$59.99
WB6006902	Heather Grey (Teal Pop Color)	\$59.99
WB6006903	Navy (Tangerine Pop Color)	\$59.99

SIZES ADULT: S, M, L, XL, 2X, 3X

Relaxed fit allows for a totally unrestricted range of motion
 Rear rib cuff with pop color detail
 Pop color drawcord and embroidered logo
 Two front pockets
 Rear pocket with zippered closure
 Fabric: 95% Cotton / 5% Spandex French Terry
 Decoration: Additional cost

MODEL

FIT Athletic // HEIGHT 6' 2" // WAIST 32" // WAIST 33.5"
 WEARING SIZE Medium



NEW EVOSHIELD® 365 FLEECE JOGGER

COLOR	ARTICLE	MSRP	ARTICLE	MSRP
Black	WB6016301	\$54.99	WB6016401	\$49.99
Heather Grey	WB6016302	\$54.99	WB6016402	\$49.99
SIZES ADULT: S, M, L, XL, 2X, 3X			SIZES YOUTH: YS, YM, YL	

Fleece Jogger pant with relaxed fit
 2 front pockets
 Soft rib waistband with adjustable drawcord
 2-ply rib cuff
 Moisture wicking
 Fabric: 97% Recycled polyester / 3% Spandex
 Fabric Heather Grey: 77% Recycled Polyester / 19% Polyester
 4% Spandex
 Decoration: Additional cost

MODEL

FIT Relaxed // HEIGHT 5' 11" // WAIST 30" // WAIST 32"
 WEARING SIZE Medium



NEW EVOSHIELD® 365 FLEECE OPEN BOTTOM

ARTICLE	COLOR	MSRP
WB6028301	Black	\$54.99
WB6028302	Heather Grey	\$54.99

SIZES ADULT: S, M, L, XL, 2X, 3X

Fleece open bottom pant with relaxed fit
 2 front pockets
 Soft rib waistband with outer drawcord
 Moisture wicking
 Fabric: 97% Recycled polyester / 3% Spandex
 Fabric Heather Grey: 77% Recycled Polyester / 19% Polyester
 4% Spandex
 Decoration: Additional cost

MODEL

FIT Relaxed // HEIGHT 5' 11" // WAIST 30" // WAIST 32"
 WEARING SIZE Medium



EVOSHIELD® HYBRID PULLOVER

ARTICLE	COLOR	MSRP
WB6015901	Black	\$69.99
WB6015902	Navy	\$69.99
WB6015903	Olive	\$69.99
WB6015904	Pebble	\$69.99

SIZES ADULT: S, M, L, XL, 2X, 3X

Athletic fit provides contoured, slim silhouette
 Kangaroo front pocket
 Mesh cutout on back with panel covering
 Reflective taping
 Drawcord at hem
 Fabric: 38% Cotton / 58% Polyester / 4% Spandex and 88% Nylon / 12%
 Spandex Woven
 Decoration: Additional cost

MODEL

FIT Athletic // HEIGHT 5' 11 1/4" // CHEST 38" // WAIST 31"
 WEARING SIZE Medium



EVOSHIELD® WOVEN JOGGER

ARTICLE	COLOR	MSRP
WB6015701	Black	\$64.99
WB6015702	Navy	\$64.99
WB6015703	Olive	\$64.99
WB6015704	Pebble	\$64.99

SIZES ADULT: S, M, L, XL, 2X, 3X

Athletic fit provides contoured, slim silhouette
 Two front zippered pockets
 One rear functional zippered pocket and one faux pocket
 Perforation at back of knee
 Reflective taping
 Internal waistband
 Fabric: 88% Nylon / 12% Spandex Woven
 Decoration: Additional cost

MODEL

FIT Athletic // HEIGHT 5' 11 1/4" // WAIST 31" // INSEAM 31"
 WEARING SIZE Medium



EVOSHIELD® BOMBER JACKET

ARTICLE	COLOR	MSRP
WB6007001	Black	\$99.99
WB6007002	Charcoal	\$99.99
WB6007003	Navy	\$99.99

SIZES ADULT: S, M, L, XL, 2X, 3X

Athletic fit provides contoured, slim silhouette
 Two side pockets with snap closure
 Rib cuff, collar and bottom band
 Quilted interior lining
 Fabric: 100% Polyester
 Decoration: Additional cost

MODEL

FIT Athletic // HEIGHT 6' 2" // CHEST 37" // WAIST 32"
 WEARING SIZE Medium



EVOSHIELD® SEAMLESS TRAINING TEE

ARTICLE	COLOR	MSRP
WB6013601	Black	\$54.99
WB6013602	Lagoon	\$54.99
WB6013603	Navy	\$54.99
WB6013604	Pebble	\$54.99

SIZES ADULT: S, M, L, XL, 2X, 3X

Athletic fit provides contoured, slim silhouette
 Engineered mesh ventilation
 Seamless construction
 Fabric: 65% Nylon / 35% Polyester
 Decoration: Additional cost

MODEL

FIT Athletic // HEIGHT 6' 2" // CHEST 37" // WAIST 32"
 WEARING SIZE Medium



EVOSHIELD® FULL ZIP HOODIE

ARTICLE	COLOR	MSRP
WB6015401	Black	\$74.99
WB6015402	Navy	\$74.99
WB6015403	Olive	\$74.99
WB6015404	Pebble	\$74.99

SIZES ADULT: S, M, L, XL, 2X, 3X

Athletic fit provides contoured, slim silhouette
 Two front zippered pockets
 Rib cuff and hem
 Three-piece lined hood
 Midweight fabric makes this a perfect year-round piece
 Fabric: 38% Cotton / 58% Polyester / 4% Spandex
 Decoration: Additional cost

MODEL

FIT Athletic // HEIGHT 5' 11¼" // CHEST 38" // WAIST 31"
 WEARING SIZE Medium



EVOSHIELD® RECOVERY DNA 21 COMPRESSION TIGHT

ARTICLE	COLOR	MSRP
WB6005701	Black	\$139.99

SIZES ADULT: S, M, L, XL, 2X

Strategic body-mapped compression for improved muscle recovery, intended to help shorten recovery time

Graduated compression

Four-way stretch fabric delivers enhanced comfort and function

Encased drawcord

Seamless construction

Designed for post-game wear

Antimicrobial protection

Fabric: 70% Nylon / 30% Spandex

MODEL

FIT Fitted Compression // **HEIGHT** 6' 2" // **WAIST** 32" // **INSEAM** 33.5"

WEARING SIZE Small



EVOSHIELD® RECOVERY DNA 21 ARM SLEEVES

ARTICLE	COLOR	MSRP
WB6005801	Black	\$34.99

SIZES ADULT: S/M, M/L, L/XL

Strategic body-mapped compression for improved muscle recovery, intended to help shorten recovery time

Graduated compression

Four-way stretch fabric delivers enhanced comfort and function

Seamless construction

Designed for post-game wear

Antimicrobial protection

Fabric: 70% Nylon / 30% Spandex

MODEL

FIT Fitted Compression // **HEIGHT** 6' 1"

WEARING SIZE M/L



EVOSHIELD® SOLID ARM SLEEVE

COLOR	ARTICLE	MSRP	ARTICLE	MSRP
Black	WB6001201	\$19.99	WB6001301	\$19.99
Charcoal	WB6001202	\$19.99	WB6001302	\$19.99
Navy	WB6001203	\$19.99	WB6001303	\$19.99
Royal	WB6001204	\$19.99	WB6001304	\$19.99
Scarlet	WB6001205	\$19.99	WB6001305	\$19.99
Team White	WB6001206	\$19.99	WB6001306	\$19.99
SIZES ADULT: SM/LXL			SIZES YOUTH: YH	

Lightweight fabric with moisture control
 Metallic logo
 Fabric: 80% Polyester / 20% Elastane

MODEL

HEIGHT 6' 1"
 WEARING SIZE LXL



EVOSHIELD® ¾ SLIDING TIGHTS

COLOR	ARTICLE	MSRP	ARTICLE	MSRP
Black	WB6006301	\$59.99	WB6006401	\$54.99
SIZES ADULT: S, M, L, XL, 2X			SIZES YOUTH: YS, YM, YL	

¾ length design
 Fitted design to tightly hug the shape of your body, without restricting movement
 EVA Knee Pad protection for improved durability
 Foam padding strategically placed to provide durability during impact of sliding
 Flat seams reduce chafing
 Mesh gusset provides ventilation
 Four-way stretch fabric delivers enhanced comfort and function
 Wide elastic waistband
 Moisture-wicking design helps keep you dry and cool
 Fabric: 84% Nylon / 16% Spandex

MODEL

FIT Fitted // HEIGHT 6' 1" // WAIST 32" // INSEAM 32"
 WEARING SIZE Medium

THE TEAM SHOP IDENTITY.

The biggest selection, the best products, the one-stop-shop to get your team ready for the season. Create a unique experience with thousands of jersey and team gear options to outfit your team with the best brands in baseball.

TEAM.SHOP

TEAM SHOP



Exclusive team pricing



No money collection or bill paying



24/7 access to stock goods at team discount



Free direct-to-player shipping



One-stop shop for uniforms and apparel



Direct customer service support



Exclusive access to limited-edition product

BASEBALL



FP STOCK UNIFORMS



FASTPITCH STOCK UNIFORMS

2023

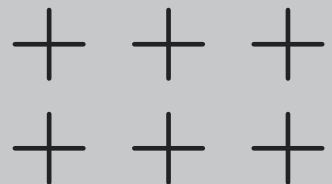

FASTPITCH STOCK JERSEY GALLERY



E304 [p. 68]



T600 [p. 67]



E306 [p. 68]



FX [p. 67]



T600 [p. 67]



E810 [p. 67]



FX [p. 67]



T600 [p. 67]



E304 [p. 68]



T600 [p. 67]



FX [p. 67]



E306 [p. 68]



E810 [p. 67]



FX [p. 67]



E810 [p. 67]

EVOSHIELD®

FX™ Training Tee

Shown With:

- WTL4954: 2-color custom screen transfer lettering
- WTL4925: 2-color NCAA® screen transfer numeral on front and back

PRICE AS SHOWN
\$59⁹⁹

Available Decoration:
• Screen Transfer
• Film Transfer



JERSEY FEATURES:

- 100% Polyester
- Athletic fit
- Performance stretch
- Can be worn as a jersey, workout shirt or under a jersey

WOMEN'S SIZES
XS-2X

WOMEN	MSRP
WTV9901	\$29 ⁹⁹



Fit: Athletic
Model:
Ht: 5ft 9"
Wearing Size Medium



EVOSHIELD®

E810 V-Neck Pullover Jersey

Shown With:

- WTL4964: 3-Color Custom screen transfer lettering
- WTL4927: 3-Color Vortex screen transfer numerals on front
- WTL4927: 3-Color Vortex screen transfer numerals on the back

PRICE AS SHOWN
\$61⁹⁹

Available Decoration:
• Screen Transfer
• Film Transfer



JERSEY FEATURES:

- 100% Polyester Pin Dot Mesh
- Relaxed fit
- Contrasting shoulder and sleeve inserts
- Lightweight moisture wicking fabric

WOMEN'S SIZES
XS-2X

GIRLS' SIZES
S-L

WOMEN	MSRP	GIRLS	MSRP
WTV4620	\$28 ⁹⁹	WTV5620	\$26 ⁹⁹



Fit: Relaxed
Model Measurements:
Ht: 5'11"
Bust: 36"
Waist: 27"
Hips: 37.5"
Wearing Size Small

DEMARINI®

T600 2-Button Placket Pullover

Shown With:

- WTL4954: 2-Color Script Screen Transfer lettering
- WTL4925: 2-Color Full Block screen transfer numerals on front
- WTL4925: 2-Color Full Block screen transfer numerals on back

PRICE AS SHOWN
\$57⁹⁹

Available Decoration:
• Screen Transfer
• Film Transfer



JERSEY FEATURES:

- 100% Polyester Pin Dot
- Relaxed fit
- White piping outlines neck
- Breathable white side inserts
- Lightweight moisture wicking antimicrobial fabric

WOMEN'S SIZES
XS-2X

GIRLS' SIZES
S-L

WOMEN	MSRP	GIRLS	MSRP
WTD4500	\$27 ⁹⁹	WTD5500	\$25 ⁹⁹



Fit: Relaxed
Model Measurements:
Ht: 5'11"
Bust: 36"
Waist: 27"
Hips: 37.5"
Wearing Size Small



EVOSHIELD®

E304 Performance Pullover Heather Tech Tee™

Shown With:

- WTL4954: 2-Color Custom screen transfer lettering
- WTL4925: 2-Color Full Block screen transfer numerals on front
- WTL4925: 2-Color Full Block screen transfer numerals on back

PRICE AS SHOWN
\$54⁹⁹

Available Decoration:
• Screen Transfer
• Film Transfer

Fit: Athletic

Model Measurements:
Ht: 5ft 11"
Chest: 36"
Waist: 27"
Hips: 37.5"
Wearing Size Small



JERSEY FEATURES:

- 100% Polyester Interlock
- Athletic fit
- Crew neck construction
- Can be worn as a jersey, workout shirt, or under a jersey
- Lightweight moisture wicking antimicrobial fabric
- Unisex for a traditional hip-length men's fit and oversized women's fit

ADULT SIZES **S-3X**
YOUTH SIZES **S-L**

ADULT	MSRP	YOUTH	MSRP
WTV1108	\$24 ⁹⁹	WTV2108	\$23 ⁹⁹



EVOSHIELD®

E306 Performance Pullover Tech Tee™

Shown With:

- WTL4954: 2-Color Custom screen transfer lettering
- WTL4925: 2-Color Full Block screen transfer numerals on front
- WTL4925: 2-Color Full Block screen transfer numerals on back

PRICE AS SHOWN
\$49⁹⁹

Available Decoration:
• Screen Transfer
• Film Transfer

Fit: Athletic

Model Measurements:
Ht: 5ft 11"
Chest: 36"
Waist: 27"
Hips: 37.5"
Wearing Size Small



JERSEY FEATURES:

- 100% Polyester Interlock
- Athletic fit, crew neck construction
- Can be worn as a jersey, workout shirt, or under a jersey
- Lightweight moisture wicking fabric
- Unisex for a traditional hip-length men's fit and oversized women's fit

ADULT SIZES **S-3X**
YOUTH SIZES **S-L**

ADULT	MSRP	YOUTH	MSRP	
WB6003401	\$19. ⁹⁹	WB6003501	\$18. ⁹⁹	BLACK
WB6003402	\$19. ⁹⁹	WB6003502	\$18. ⁹⁹	CARDINAL
WB6003403	\$19. ⁹⁹	WB6003503	\$18. ⁹⁹	CHARCOAL
WB6003404	\$19. ⁹⁹	WB6003504	\$18. ⁹⁹	DARK GREEN
WB6003406	\$19. ⁹⁹	WB6003506	\$18. ⁹⁹	MAROON
WB6003407	\$19. ⁹⁹	WB6003507	\$18. ⁹⁹	NAVY
WB6003408	\$19. ⁹⁹	WB6003508	\$18. ⁹⁹	ORANGE
WB6003409	\$19. ⁹⁹	WB6003509	\$18. ⁹⁹	PINK
WB6003410	\$19. ⁹⁹	WB6003510	\$18. ⁹⁹	PURPLE
WB6003411	\$19. ⁹⁹	WB6003511	\$18. ⁹⁹	ROYAL
WB6003412	\$19. ⁹⁹	WB6003512	\$18. ⁹⁹	SCARLET
WB6003413	\$19. ⁹⁹	WB6003513	\$18. ⁹⁹	TEAM WHITE
WB6003415	\$19. ⁹⁹	WB6003515	\$18. ⁹⁹	TEXAS ORANGE
WB6003416	\$19. ⁹⁹	WB6003516	\$18. ⁹⁹	LIGHT GOLD
WB6003417	\$19. ⁹⁹	WB6003517	\$18. ⁹⁹	VICTORY BLUE



EVOSHIELD[®] FX™ GAME LOW RISE

PANT FEATURES:

- 87% Polyester/ 13% Spandex (8 oz.)
- Fabric has soft hand with performance stretch
- Low-rise athletic fit with elastic bottom
- Contoured leg and double knees
- 2 set-in back pockets
- Logo elastic gripper waistband
- Moisture wicking fabric helps keep you dry and cool

WOMEN'S SIZES
XS-2X

GIRLS' SIZES
S-XL



PIPING AVAILABLE \$9.00



WOMEN: GRADUATED INSEAMS
GIRLS: GRADUATED INSEAMS



COLORS	WOMEN	MSRP	GIRLS	MSRP
Black	WB6002801	\$49 ⁹⁹	WB6002901	\$44 ⁹⁹
Blue Grey	WB6002802	\$49 ⁹⁹	WB6002902	\$44 ⁹⁹
Charcoal	WB6002808	\$49 ⁹⁹	WB6002908	\$44 ⁹⁹
Navy	WB6002804	\$49 ⁹⁹	WB6002904	\$44 ⁹⁹
Royal	WB6002805	\$49 ⁹⁹	WB6002905	\$44 ⁹⁹
Scarlet	WB6002806	\$49 ⁹⁹	WB6002906	\$44 ⁹⁹
Team White	WB6002807	\$49 ⁹⁹	WB6002907	\$44 ⁹⁹

WOMEN'S GRADUATED INSEAMS: WB60028

SIZE	INSEAM
XS	18.5"
S	18.5"
M	19"
L	19"
XL	19.5"
2XL	19.5"

GIRLS GRADUATED INSEAMS: WB60029

SIZE	INSEAM
S	13"
M	15"
L	17"
XL	17"

EVOSHIELD[®] STANDOUT™ HIGH RISE

PANT FEATURES:

- 100% Polyester Double Knit (8.5 oz.)
- Pro style high-rise fitted body with fly front and elastic bottom
- Reinforced double layered knees
- 2 set-in back pockets
- Wordmark gripper elastic waistband with drawcord
- Pro tunnel loops
- Moisture wicking fabric helps keep you dry and cool

WOMEN'S SIZES
XS-3X

GIRLS' SIZES
S-XL



PIPING AVAILABLE \$9.00



WOMEN: 20" INSEAM
GIRLS: GRADUATED INSEAMS



COLORS	WOMEN	MSRP	GIRLS	MSRP
Black	WB6008301	\$49 ⁹⁹	WB6008401	\$44 ⁹⁹
Blue Grey	WB6008302	\$49 ⁹⁹	WB6008402	\$44 ⁹⁹
Charcoal	WB6008303	\$49 ⁹⁹	WB6008403	\$44 ⁹⁹
Navy	WB6008304	\$49 ⁹⁹	WB6008404	\$44 ⁹⁹
Royal	WB6008308	\$49 ⁹⁹	WB6008408	\$44 ⁹⁹
Scarlet	WB6008306	\$49 ⁹⁹	WB6008406	\$44 ⁹⁹
Team White	WB6008307	\$49 ⁹⁹	WB6008407	\$44 ⁹⁹

GIRLS GRADUATED INSEAMS: WB60084

SIZE	INSEAM
GS	14"
GM	16"
GL	18"
GXL	19"

DEMARINI[®] FIERCE™ MID RISE

PANT FEATURES:

- 100% Polyester Double Knit (8 oz.)
- Mid-rise athletic fit with elastic bottom
- Double layered knees
- 2-set in back pockets
- Wordmark gripper elastic waistband with drawcord
- Moisture wicking fabric helps keep you dry and cool

WOMEN'S SIZES
S-2X

GIRLS' SIZES
XS-L



PIPING AVAILABLE \$9.00



WOMEN: 22" INSEAM
GIRLS: GRADUATED INSEAMS



COLORS	WOMEN	MSRP	GIRLS	MSRP
Black	WTD3040BL	\$44 ⁹⁹	WTD4040BL	\$39 ⁹⁹
Blue Grey	WTD3040BG	\$44 ⁹⁹	WTD4040BG	\$39 ⁹⁹
Charcoal	WTD3040CH	\$44 ⁹⁹	WTD4040CH	\$39 ⁹⁹
Navy	WTD3040NA	\$44 ⁹⁹	WTD4040NA	\$39 ⁹⁹
Royal	WTD304001	\$44 ⁹⁹	WTD404001	\$34 ⁹⁹
Scarlet	WTD3040SC	\$44 ⁹⁹	WTD4040SC	\$34 ⁹⁹
Team White	WTD3040TW	\$44 ⁹⁹	WTD4040TW	\$34 ⁹⁹

GIRLS GRADUATED INSEAMS: WTD4040

SIZE	INSEAM
XS	12"
S	14"
M	16"
L	18"

EVOSHIELD®
PRO-SRZ STRIPED GAME SOCKS

SOCK FEATURES:

- 58% Nylon/28% Polyester/8% Cotton/6% Spandex
- Variegated rib leg
- Graduated compression for a perfect fit
- Spot ankle and Achilles cushioning provide improved comfort
- Deep heel pocket
- Ergonomic sole cushioning and toe cushioning
- Mesh ventilation help keep your feet dry and cool on the field
- Arch support for enhanced comfort

UNISEX	MSRP
WB60105	\$14 ⁹⁹



UNISEX SIZES
S-XL

01 [BL] 02 [DG] 03 [LG] 13 [MA] 05 [NA] 06 [OR] 07 [PR] 08 [RO] 09 [SC] 11 [VB] 12 [TO]

EVOSHIELD®
GAME SOCKS

SOCK FEATURES:

- 93% Polyester/6% Spandex /1% Nylon over-the-calf knee high
- Extended Achilles cushioning
- Variegated leg rib; accented arch support
- Space-dyed ergonomic cushioning
- Moisture wicking

UNISEX	MSRP
WTV4446	\$10 ⁹⁹



UNISEX SIZES
S-XL

TO [01] BL DG LG MA NA OR PR RO SC TW VB

SOCK SIZING

SOCK	SHOE SIZE		
	MEN	WOMEN	KIDS
S	—	4-6	3Y-5Y
M	6-8	6-10	5Y-7Y
L	8-12	10-13	—
XL	12-15	—	—



WILSON®
ELASTIC BELT

BELT FEATURES:

- Adult 1½" wide is one-size-fits-most
- Youth 1" wide fits waist sizes 18-32"
- Minimum order is 6 per style, color

ADULT	MSRP	YOUTH	MSRP
WTA4442	\$7 ⁹⁹	WTA4444	\$6 ⁹⁹



ADULT SIZE | YOUTH SIZE
1½" | 1"

BLA DKGN LG [02]
MAR NAV ORA
PUR ROY SCA
TO [01] VB WHI



FP TEAM APPAREL

FP TEAM APPAREL



FASTPITCH TEAM APPAREL

 @TEAM.SHOP.OFFICIAL
 @TEAM_SHOP_
 @TEAMSHOPOFFICIAL

2023

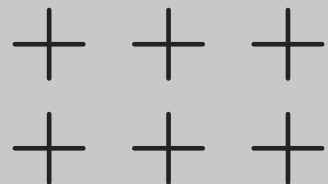



EVOSHIELD® FX™ SHORT SLEEVE TRAINING TEE

MODEL NO.	SIZES	MSRP
WTV9901	WOMEN: XS, S, M, L, XL, 2X	\$29.99

Athletic fit provides contoured, slim silhouette
 Performance stretch
 Can be worn as a jersey, workout shirt or under a jersey
 Fabric: 100% Polyester
 Decoration: Additional cost

MODEL

FIT Athletic
 HEIGHT 5' 9"
 WEARING SIZE Medium



EVOSHIELD® FX™ LONG SLEEVE TRAINING TEE

MODEL NO.	SIZES	MSRP
WTV9902	WOMEN: XS, S, M, L, XL, 2X	\$34.99

Athletic fit provides contoured, slim silhouette
 Performance stretch
 Wear alone or layered
 Fabric: 100% Polyester
 Decoration: Additional cost

MODEL

FIT Athletic
 HEIGHT 5' 9"
 WEARING SIZE Medium



EVOSHIELD® FX™ TRAINING TANK

MODEL NO.	SIZES	MSRP
WTV3003	WOMEN: S, M, L, XL, 2X	\$29.99

Athletic fit provides contoured, slim silhouette
 Performance stretch
 Key hole back
 Fabric: 100% Polyester
 Decoration: Additional cost

MODEL

FIT Athletic
 HEIGHT 5' 7"
 WEARING SIZE Small



BACK DETAIL



EVOSHIELD® TRAINING TANK

ARTICLE	COLOR	MSRP
WB6016801	Black	\$29.99
WB6016802	Citrine	\$29.99
WB6016803	Papaya	\$29.99
WB6016804	Pearl	\$29.99

SIZES WOMEN: XS, S, M, L, XL, 2X

Athletic fit provides contoured, slim silhouette
 Racerback
 Fabric: 65% Nylon / 35% Spandex
 Decoration: Additional cost

MODEL

FIT Athletic // HEIGHT 5' 8" // BUST 34" // WAIST 24" // HIPS 34"
 WEARING SIZE X Small



WSL EVOSHIELD® SHORT SLEEVE COOLING TEE

ARTICLE	COLOR	MSRP
WB6017101	Black	\$39.99
WB6017102	Navy	\$39.99
WB6017103	Royal	\$39.99
WB6017104	Scarlet	\$39.99
WB6017105	Team White	\$39.99

SIZES WOMEN: XS, S, M, L, XL, 2X

Fitted design tightly hugs the shape of your body, without restricting movement
 Advanced fabric technology to keep you cool and dry
 UPF rated 50+ for sun protection
 Ergonomic flat seaming
 Moisture-wicking design helps keep you dry and cool
 Racerback
 Fabric: 88% Polyester / 12% Spandex
 Decoration: Additional cost

MODEL

FIT Athletic // HEIGHT 5' 8" // BUST 34" // WAIST 24" // HIPS 34"
 WEARING SIZE X Small



WSL EVOSHIELD® LONG SLEEVE COOLING TEE

ARTICLE	COLOR	MSRP
WB6007901	Black	\$49.99
WB6007903	Navy	\$49.99
WB6007904	Royal	\$49.99
WB6007905	Scarlet	\$49.99
WB6007906	Team White	\$49.99

SIZES WOMEN: XS, S, M, L, XL, 2X

Fitted design to tightly hug the shape of your body, without restricting movement
 Advanced fabric technology to keep you cool and dry
 UPF rated 50+ for sun protection
 Ergonomic flat seaming
 Moisture-wicking design helps keep you dry and cool
 Fabric: 88% Polyester / 12% Spandex
 Decoration: Additional cost

MODEL

FIT Fitted // HEIGHT 5' 10" // BUST 34" // WAIST 28.5" // HIPS 40"
 WEARING SIZE Medium



EVOSHIELD® LIGHTWEIGHT TRAINING HOODIE

ARTICLE	COLOR	MSRP
WB6016901	Black	\$44.99
WB6016902	Navy	\$44.99
WB6016903	Pearl	\$44.99
WB6016904	Plum	\$44.99

SIZES WOMEN: XS, S, M, L, XL, 2X

Athletic fit provides contoured, slim silhouette
 Three-piece hood
 Four-way stretch fabric delivers enhanced comfort and function
 Moisture-wicking fabric helps keep you dry and cool
 Fabric: 88% Nylon / 12% Spandex
 Decoration: Additional cost

MODEL

FIT Fitted // HEIGHT 5' 8" // BUST 34" // WAIST 24" // HIPS 34"
 WEARING SIZE X Small



EVOSHIELD® FX™ WOVEN TRAINING SHORT

ARTICLE	COLOR	MSRP
WB6006101	Black* {Also available in XXS}	\$39.99
WB6006102	Charcoal	\$39.99
WB6006103	Navy* {Also available in XXS}	\$39.99
WB6006104	Royal	\$39.99
WB6006105	Scarlet	\$39.99

SIZES WOMEN: XS, S, M, L, XL, 2X

Athletic fit provides contoured, slim silhouette
 1 Rear pocket
 4 1/4" inseam
 Interior circular drawcord
 Fabric: 88% Nylon / 12% Spandex Stretch Woven
 Decoration: Additional cost

MODEL

FIT Athletic // HEIGHT 5' 10" // WAIST 28.5" // HIPS 40"
 WEARING SIZE Medium



NEW EVOSHIELD® LEGGING

ARTICLE	COLOR	MSRP
WB6016701	Black	\$49.99

SIZES WOMEN: XS, S, M, L, XL, 2X

Fitted design to tightly hug the shape of your body, without restricting movement
 High waisted
 Side pocket
 Hidden waistband pocket
 Four way stretch, moisture wicking fabric
 Perforated ventilation
 7/8 length intended to sit above the ankle
 Fabric: 76% Eco Polyester / 24% Spandex

MODEL

FIT Athletic // HEIGHT 5' 11" // WAIST 27" // HIPS 37.5"
 WEARING SIZE Small



01 [BLACK] 02 [HEATHER GREY] 03 [NAVY]



04 [ROYAL] 05 [SCARLET] 06 [TEAM WHITE]



NEW EVOSHIELD® 365 FLEECE HOODIE

COLOR	ARTICLE	MSRP	ARTICLE	MSRP
Black	WB6017001	\$59.99	WB6015301	\$54.99
Heather Grey	WB6017002	\$59.99	WB6015302	\$54.99
Navy	WB6017003	\$59.99	WB6015303	\$54.99
Royal	WB6017004	\$59.99	WB6015304	\$54.99
Scarlet	WB6017005	\$59.99	WB6015305	\$54.99
Team White	WB6017006	\$59.99	WB6015306	\$54.99
SIZES WOMEN: XS, S, M, L, XL, 2X			SIZES YOUTH: YS, YM, YL	

Relaxed fit
 Kangaroo front pocket
 3-piece hood
 Shoulder and sleeve rib placement allows for unrestricted full range of motion
 2-ply rib cuff and bottom band
 Moisture wicking
 Fabric: 97% Recycled polyester / 3% Spandex
 Fabric Heather Grey: 77% Recycled Polyester / 19% Polyester 4% Spandex
 Decoration: Additional cost

MODEL

FIT Relaxed // HEIGHT 5' 11" // BUST 36" // WAIST 27" // HIPS 37.5"
 WEARING SIZE Small



01 [BLACK] 02 [HEATHER GREY]



NEW EVOSHIELD® 365 FLEECE JOGGER

ARTICLE	COLOR	MSRP
WB6028401	Black	\$54.99
WB6028402	Heather Grey	\$54.99

SIZES WOMEN: XS, S, M, L, XL, 2X

Fleece jogger pant with relaxed fit
 2 front pockets
 Soft rib waistband with outer drawcord
 2-ply rib cuff
 Moisture wicking
 Fabric: 97% Recycled polyester / 3% Spandex
 Fabric Heather Grey: 77% Recycled Polyester / 19% Polyester 4% Spandex
 Decoration: Additional cost

MODEL

FIT Relaxed // HEIGHT 5' 11" // WAIST 27" // HIPS 37.5"
 WEARING SIZE Small



WSL EVOSHIELD® TERRY SWEATSHIRT

ARTICLE	COLOR	MSRP
WB6006001	Black	\$59.99
WB6006002	Heather Grey	\$59.99
WB6006003	Navy	\$59.99
WB6006004	Royal	\$59.99
WB6006005	Scarlet	\$59.99

SIZES WOMEN: XS, S, M, L, XL, 2X

Athletic fit provides contoured, slim silhouette
 Concealed front kangaroo pocket
 Drop shoulder
 Rib mock neck, cuffs, and hem
 Side vent
 Fabric: 95% Cotton / 5% Spandex French Terry
 Decoration: Additional cost

MODEL

FIT Athletic // HEIGHT 5' 9.5" // BUST 36" // WAIST 30" // HIPS 41"
 WEARING SIZE Medium



EVOSHIELD® RACERBACK TANK

MODEL NO.	MSRP
WTV3002	\$22.99

SIZES WOMEN: S, M, L, XL, 2X

Athletic fit provides contoured, slim silhouette
 Heathered fabric
 Racerback cut gives you freedom to move
 Ribbed neck and armholes
 Contoured hem
 Fabric: 52% Polyester / 48% Cotton Heathered Fabric
 Decoration: Additional cost

MODEL

FIT Athletic // HEIGHT 5' 7"
 WEARING SIZE Small



EVOSHIELD® HEATHER SHORT SLEEVE TEE

COLOR	ARTICLE	MSRP	ARTICLE	MSRP
Black	WTV3001BL	\$24.99	WTV2002BL	\$19.99
Cardinal	WTV300101	\$24.99	WTV200201	\$19.99
Charcoal	WTV3001CH	\$24.99	WTV2002CH	\$19.99
Dark Green	WTV3001DG	\$24.99	WTV2002DG	\$19.99
Light Gold	WTV300102	\$24.99	WTV200202	\$19.99
Light Grey	WTV3001GR	\$24.99	WTV2002GR	\$19.99
Maroon	WTV3001MA	\$24.99	WTV2002MA	\$19.99
Navy	WTV3001NA	\$24.99	WTV2002NA	\$19.99
Orange	WTV300105	\$24.99	WTV200205	\$19.99
Purple	WTV3001PR	\$24.99	WTV2002PR	\$19.99
Royal	WTV3001RO	\$24.99	WTV2002RO	\$19.99
Scarlet	WTV3001SC	\$24.99	WTV2002SC	\$19.99
Team White	WTV3001TW	\$24.99	WTV2002TW	\$19.99
Texas Orange	WTV300103	\$24.99	WTV200203	\$19.99
SIZES WOMEN: XS, S, M, L, XL, 2X			SIZES YOUTH: S, M, L	

Athletic fit provides contoured, slim silhouette
 Heathered fabric
 Ribbed crew neck
 Fabric: 52% Polyester / 48% Cotton Heathered Fabric
 Decoration: Additional cost

MODEL

FIT Athletic // HEIGHT 5' 10" // BUST 34" // WAIST 28.5" // HIPS 40"
 WEARING SIZE Medium



EVOSHIELD® HEATHER LONG SLEEVE TEE

COLOR	ARTICLE	MSRP	ARTICLE	MSRP
Black	WTV1001BL	\$27.99	WTV2001BL	\$22.99
Charcoal	WTV1001CH	\$27.99	WTV2001CH	\$22.99
Light Grey	WTV1001GR	\$27.99	WTV2001GR	\$22.99
Navy	WTV1001NA	\$27.99	WTV2001NA	\$22.99
Royal	WTV1001RO	\$27.99	WTV2001RO	\$22.99
Scarlet	WTV1001SC	\$27.99	WTV2001SC	\$22.99
Team White	WTV1001TW	\$27.99	WTV2001TW	\$22.99
SIZES ADULT: S, M, L, XL, 2X, 3X			SIZES YOUTH: S, M, L	

Athletic fit provides contoured, slim silhouette
 Unisex for a traditional hip-length men's fit and oversized women's fit
 Heathered fabric
 Rib crew neck
 Fabric: 52% Polyester / 48% Cotton Heathered Fabric
 Decoration: Additional cost

MODEL

FIT Athletic // HEIGHT 5' 11" // BUST 36" // WAIST 27" // HIPS 37.5"
 WEARING SIZE Small



WSL EVOSHIELD® MID SLEEVE TEE

ARTICLE	COLOR	MSRP
WB6001001	Charcoal/Black	\$24.99
WB6001002	Charcoal/Navy	\$24.99
WB6001003	Charcoal/Scarlet	\$24.99
WB6001004	Charcoal/Royal	\$24.99
WB6001005	Charcoal/Maroon	\$24.99
WB6001006	Charcoal/Purple	\$24.99
WB6001007	Charcoal/Dark Green	\$24.99

SIZES WOMEN: XS, S, M, L, XL, 2X

Athletic fit provides contoured, slim silhouette
 Raglan ¾ length sleeves
 Contrast body
 Rib crew neck
 Fabric: 52% Polyester / 48% Cotton Heathered fabric
 Decoration: Additional cost

MODEL

FIT Athletic // HEIGHT 5' 8" // BUST 34" // WAIST 24" // HIPS 34"
 WEARING SIZE Small



EVOSHIELD® FITTED LONG SLEEVE

ARTICLE	COLOR	MSRP
WB6017301	Black	\$34.99
WB6017302	Pearl	\$34.99
WB6017303	Plum	\$34.99

SIZES WOMEN: XS, S, M, L, XL, 2X

Fitted design to tightly hug the shape of your body, without restricting movement
 Crew neck
 Fabric: 88% Nylon / 12% Spandex
 Decoration: Additional cost

MODEL

FIT Fitted // HEIGHT 5' 10" // BUST 34" // WAIST 28.5" // HIPS 40"
 WEARING SIZE Medium



02 [HEATHER GREY] 03 [NAVY]



02 [HEATHER GREY] 03 [NAVY]



01 [BLACK] 02 [CHARCOAL] 03 [NAVY]



WSL EVOSHIELD® POP COLOR TERRY HOODIE

ARTICLE	COLOR	MSRP
WB6007402	Heather Grey (Cherry Pop Color)	\$59.99
WB6007403	Navy (Spring Green Pop Color)	\$59.99

SIZES WOMEN: XS, S, M, L, XL, 2X

Relaxed fit allows for a totally unrestricted range of motion
 Front kangaroo pocket
 Rib cuff and hem
 Three-piece hood
 Pop color drawcord and embroidered logo
 Pin tuck detailing
 Midweight fabric makes this a perfect year-round piece
 Fabric: 95% Cotton / 5% Spandex French Terry
 Decoration: Additional cost

MODEL

FIT Athletic // HEIGHT 5' 10" // BUST 34" // WAIST 28.5" // HIPS 40"
WEARING SIZE Medium

WSL EVOSHIELD® POP COLOR TERRY JOGGER

ARTICLE	COLOR	MSRP
WB6007302	Heather Grey (Cherry Pop Color)	\$59.99
WB6007303	Navy (Spring Green Pop Color)	\$59.99

SIZES WOMEN: XS, S, M, L, XL, 2X

Relaxed fit allows for a totally unrestricted range of motion
 Rib cuff
 Two front pockets
 Pintuck detailing
 Pop color drawcord and embroidered logo
 Fabric: 95% Cotton / 5% Spandex French Terry
 Decoration: Additional cost

MODEL

FIT Athletic // HEIGHT 5' 10" // CHEST 34" // WAIST 28.5" // HIPS 40"
WEARING SIZE Medium

EVOSHIELD® WOVEN JOGGER

ARTICLE	COLOR	MSRP
WB6006201	Black	\$64.99
WB6006202	Charcoal	\$64.99
WB6006203	Navy	\$64.99

SIZES WOMEN: S, M, L, XL, 2X

Athletic fit
 Elastic cuffs
 2 front pockets
 Additional side zippered pocket to stash essentials
 Exposed drawcord
 Fabric: 88% Nylon / 12% Spandex Stretch Woven

MODEL

FIT Athletic // HEIGHT 5' 10" // WAIST 28.5" // HIPS 40"
WEARING SIZE Small

THE TEAM SHOP IDENTITY.

Get your squad ready with Team Shop, the perfect tool to get your team ready for the season. Create a unique experience for your team, with thousands of jersey and team apparel options to choose from. Get exclusive benefits and access to the best brands in Fastpitch.

TEAM.SHOP

TEAM SHOP



SHOP
24/7/365



Exclusive team pricing



No money collection or bill paying



24/7 access to stock goods at team discount



Free direct-to-player shipping



One-stop shop for uniforms and apparel



Direct customer service support



Exclusive access to limited-edition product



EVOSHIELD HATS

EVOSHIELD HATS

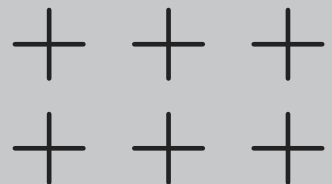



TEAM SHOP

Exclusively on team.shop



EVOSHIELD® XVT GAME HAT

ARTICLE	COLOR	MSRP
WB6001901	Black	\$29.99
WB6001902	Cardinal	\$29.99
WB6001905	Light Gold	\$29.99
WB6001906	Maroon	\$29.99
WB6001907	Navy	\$29.99
WB6001908	Orange	\$29.99
WB6001910	Scarlet	\$29.99
WB6001911	Royal	\$29.99
WB6001912	Team White	\$29.99
WB6001913	Victory Blue	\$29.99
WB6001914	White/Black	\$29.99
WB6001916	White/Maroon	\$29.99
WB6001918	White/Navy	\$29.99
WB6001920	White/Scarlet	\$29.99
WB6001921	White/Royal	\$29.99
WB6001922	White/Cardinal	\$29.99
WB6001923	White/Charcoal	\$29.99
WB6001924	White/Light Gold	\$29.99
WB6001925	White/Orange	\$29.99
WB6001926	White/Victory Blue	\$29.99
WB6001927	Texas Orange	\$29.99
WB6001928	White/Texas Orange	\$29.99
WB6001929	White/Dark Green	\$29.99
WB6001930	White/Purple	\$29.99
WB6001931	Charcoal	\$29.99
WB6001932	Dark Green	\$29.99
WB6001933	Purple	\$29.99

SIZE L/XL (7³/₁₆-7⁵/₁₆) SIZE S/M (7-7¹/₄) SIZE XS/S (6⁵/₁₆-7)

Flexfit

Mid-rise profile

Lightweight with perforated panels

Fabric: 98% Polyester / 2% Spandex performance stretch

TEAM SHOP

Exclusively on team.shop



EVOSHIELD® LYT GAME VISOR

ARTICLE	COLOR	MSRP
WB6021501	Black: One Size	\$24.99
WB6021502	Cardinal: One Size	\$24.99
WB6021503	Charcoal: One Size	\$24.99
WB6021504	Dark Green: One Size	\$24.99
WB6021505	Light Gold: One Size	\$24.99
WB6021506	Maroon: One Size	\$24.99
WB6021507	Navy: One Size	\$24.99
WB6021508	Orange: One Size	\$24.99
WB6021509	Purple: One Size	\$24.99
WB6021510	Scarlet: One Size	\$24.99
WB6021511	Royal: One Size	\$24.99
WB6021512	Team White: One Size	\$24.99
WB6021513	Victory Blue: One Size	\$24.99
WB6021514	Texas Orange: One Size	\$24.99

SIZE OSFA

Mid-rise profile

Lightweight with perforated panels

2" front panel

Hook and loop closure

Fabric: 98% Polyester / 2% Spandex performance stretch



TEAM SHOP

Exclusively on team.shop



EVOSHIELD® TEAM BUCKET HAT

ARTICLE	COLOR	MSRP
WB6020801	Black: One Size	\$34.99
WB6020802	Charcoal: One Size	\$34.99
WB6020803	Navy: One Size	\$34.99
WB6020804	Royal: One Size	\$34.99
WB6020805	Scarlet: One Size	\$34.99
WB6020806	Team White: One Size	\$34.99

SIZE OSFA

Wide brim helps shield the sun
 Laser cut holes and mesh vents in crown for breathability
 Adjustable strap and drawstring at the back for comfortable fit
 Open area for team decoration
 Fabric: 100% Polyester

TEAM SHOP

Exclusively on team.shop



EVOSHIELD® LYT SNAPBACK

ARTICLE	COLOR	MSRP
WB6019501	Black: One Size	\$29.99
WB6019502	Cardinal: One Size	\$29.99
WB6019503	Charcoal: One Size	\$29.99
WB6019504	Dark Green: One Size	\$29.99
WB6019505	Light Gold: One Size	\$29.99
WB6019506	Maroon: One Size	\$29.99
WB6019507	Navy: One Size	\$29.99
WB6019508	Orange: One Size	\$29.99
WB6019509	Purple: One Size	\$29.99
WB6019510	Scarlet: One Size	\$29.99
WB6019511	Royal: One Size	\$29.99
WB6019512	Team White: One Size	\$29.99
WB6019513	Victory Blue: One Size	\$29.99
WB6019514	Texas Orange: One Size	\$29.99

SIZE OSFA

Mid-rise profile
 Pre-curved bill
 Snapback
 Fabric: 98% Polyester / 2% Polyurethane

NEW EVOSHIELD TRUCKER SNAPBACK

ARTICLE	COLOR	MSRP
WB6029101	Black: One Size	\$29.99
WB6029102	Heather Grey: One Size	\$29.99
WB6029103	Navy: One Size	\$29.99
WB6029104	Royal: One Size	\$29.99
WB6029105	Scarlet: One Size	\$29.99

SIZE OSFA

Mid Profile
 Pre Formed Bill
 Snapback fit allows for full adjustability
 Fabric: 60% Cotton / 40% Polyester





HEATHER GREY/WHITE RED/WHITE ROYAL/WHITE

EVOSHIELD® USA SNAPBACK TRUCKER

SKU	COLOR	MSRP
WTV1034320HGOSFM	Heather Grey/White: One Size	\$24.99
WTV103432062OSFM	Red/White: One Size	\$24.99
WTV1034320430OSFM	Royal/White: One Size	\$24.99

SIZE OSFM

Embroidered raised Evoshield logo with American Flag design
 Breathable mesh back to keep you cool
 Snapback fit allows for full adjustability
 Imported
 Fabric: 53% Polyester / 47% Cotton



BLACK NAVY/WHITE

EVOSHIELD® USA FLEXFIT TRUCKER

SKU	SKU	COLOR	MSRP
WTV1035320BLLGXL	WTV1035320BLSMMD	Black	\$24.99
WTV1035320410LGXL	WTV1035320410SMMD	Navy/White	\$24.99

SIZE L/XL (7^{3/8}-7^{7/8}) SIZE S/M (7-7^{1/4})

Evoshield logo with American Flag design
 Breathable mesh back to keep you cool
 Flexfit band for ultimate comfort fit
 Pre-formed bill
 Imported
 Fabric: 56% Polyester / 42% Cotton / 2% P.U. Spandex



BLACK/WHITE USA

EVOSHIELD® XVT FLEXFIT

SKU	SKU	COLOR	MSRP
WTV8744BWLXGXL	WTV8744BWSMMD	Black/White	\$24.99
WTV8744USLXGXL	WTV8744USSMMD	USA	\$24.99

SIZE L/XL (7^{3/8}-7^{7/8}) SIZE S/M (7-7^{1/4})

3D embroidered Evoshield logo
 Flexfit band for ultimate comfort fit
 Laser cut holes with fabric backing
 Breathable mesh back to keep you cool
 Pre-formed bill
 Fabric: 60% Cotton / 40% Polyester



WHITE/HEATHER GREY

NEW EVOSHIELD® KEY WEST SNAPBACK

ARTICLE	MSRP
WB6021701	\$24.99

SIZE OSFA

Mid Profile
 Pre-formed bill
 Snapback fit allows for full adjustability
 Evoshield Woven Patch
 Fabric: 60% Cotton / 40% Polyester



SILVER

NEW EVOSHIELD® TONE SNAPBACK

ARTICLE	MSRP
WB6024001	\$24.99
SIZE OSFA	

Mid profile
 Pre-formed bill
 Snapback fit allows for full adjustability
 Evoshield rubber patch
 Lightweight with perforated panels
 Fabric: 98% Polyester / 2% Spandex Performance Stretch



BLACK

NEW EVOSHIELD® SUNUP SNAPBACK

ARTICLE	MSRP
WB6026801	\$24.99
SIZE OSFA	

Mid profile
 Pre-formed bill
 Snapback fit allows for full adjustability
 Woven patch with embroidery detail
 Fabric: 60% Cotton / 40% Polyester



CHARCOAL

USA



EVO CAMO

WHITE

EVOSHIELD® BUCKET HAT

ARTICLE	COLOR	MSRP
WTV1036000056OSFM	Evo Camo: One Size	\$24.99
WTV1036000100OSFM	White: One Size	\$24.99
WTV1036CHOSFM	Charcoal: One Size	\$24.99
WTV1038WHOSFM	USA: One Size	\$24.99
SIZE OSFA		

Wide brim helps shield the sun
 Laser cuts and mesh vents in crown for breathability
 Adjustable strap and drawstring at back for comfortable fit
 Embroidered Evoshield logo
 Fabric: 100% Polyester

WILSON BASEBALL/SOFTBALL SALES OFFICES

NORTH CENTRAL

REGIONAL SALES MANAGER

Mike O'Brien
Phone: 330-465-6254
mike.obrien@wilson.com

NORTH DAKOTA, SOUTH DAKOTA, MINNESOTA, NEBRASKA, IOWA, NORTHWEST WISCONSIN

Robert Rowen
Phone: 845-633-1278
robert.rowen@wilson.com

WISCONSIN (CENTRAL & SOUTHERN), ILLINOIS (NORTH & CENTRAL)

Rick Miller
Phone: 630-240-2675
rick.miller@wilson.com

CONNECTICUT, MASSACHUSETTS, RHODE ISLAND, NEW JERSEY, DELAWARE, GREATER NYC

Bill McDermott
Phone: 973-769-3400
bill.mcdermott@wilson.com

VERMONT, NEW HAMPSHIRE, MAINE, UPSTATE NY, MARYLAND PENNSYLVANIA

Tom Berl
Phone: 412-334-2592
tom.berl@wilson.com

WESTERN MICHIGAN, INDIANA

Andrew Coss
Phone: 312-513-8486
andrew.coss@wilson.com

OHIO, WEST VIRGINIA, EASTERN MICHIGAN

Matt Sherrieb
Phone: 330-464-5366
matt.sherrieb@wilson.com

SOUTH CENTRAL

REGIONAL SALES MANAGER

Mike Matthews
Phone: 502-295-5813
mike.matthews@wilson.com

KENTUCKY, TENNESSEE, NORTHERN ALABAMA, NORTHERN GEORGIA

Jim Conroy
Phone: 773-255-3712
jim.conroy@wilson.com

NORTHERN FLORIDA, SOUTH GEORGIA, SOUTH ALABAMA

Zane Green
Phone: 864-650-4259
zane.green@wilson.com

CENTRAL & SOUTH FLORIDA

Brian Bryant
Phone: 941-730-7697
brian.bryant@wilson.com

KANSAS, MISSOURI, SOUTHERN ILLINOIS, SOUTHERN INDIANA

John Wilson
Phone: 317-417-7704
john.wilson@wilson.com

ARKANSAS, LOUISIANA, MISSISSIPPI

Kade Garlington
Phone: 318-294-7284
kade.garlington@wilson.com

CENTRAL ALABAMA, CENTRAL GEORGIA

Ken Weinhardt
Phone: 678-643-2461
ken.weinhardt@wilson.com

VIRGINIA, NORTH CAROLINA, SOUTH CAROLINA, SOUTHERN WEST VIRGINIA

Brent Blake
Phone: 704-321-3253
brent.blake@wilson.com

WEST

REGIONAL SALES MANAGER

Jay Schindler
Phone: 713-299-7597
jayschindler@wilson.com

SOUTH TEXAS

Steve Fairbanks
Phone: 502-417-5560
steve.fairbanks@wilson.com

OKLAHOMA, NORTH TEXAS

Tyler O'Bryant
Phone: 870-260-2095
tyler.obryant@wilson.com

WASHINGTON, OREGON, IDAHO, MONTANA, ALASKA

TJ O'Donnell
Phone: 312-459-4442
tj.odonnell@wilson.com

SOUTHERN CALIFORNIA, SOUTHERN NEVADA, HAWAII

Riley Jenkins
Phone: 503-269-7619
riley.jenkins@wilson.com

NORTHERN CALIFORNIA (CENTRAL VALLEY/BAY AREA), NORTHERN NEVADA

Chris Bacigalupi
Phone: 707-217-6693
christopher.bacigalupi@amersports.com

ARIZONA, COLORADO, NEW MEXICO, UTAH, WYOMING

Chris Zeller
Phone: 949-230-3427
Chris.Zeller@wilson.com

WILSON BASEBALL CORPORATION & DISTRIBUTION

UNIFORM FACTORY

4600 Roberts-Matthews Hwy.
Sparta, TN 38583
Phone: 931-738-7500

UNIFORM CUSTOMER SERVICE

Sparta: 800-468-8647

DISTRIBUTION CENTER

2440 Couchville Pike
Nashville, TN 37217
Phone: 615-883-9133
Fax: 615-883-9332

CUSTOMER SERVICE

1 Prudential Plaza
130 East Randolph Street,
Suite 600
Chicago, IL 60601

Phone: 800-245-5454
Fax: 800-642-4600

CREDIT

1 Prudential Plaza
130 East Randolph Street,
Suite 600
Chicago, IL 60601
Phone: 800-562-1900
Fax: 773-714-4584

ATEC ATHLETIC TRAINING EQUIPMENT COMPANY

CUSTOMER SERVICE

655 Spice Island Drive
Sparks, NV 89431
Phone: 800-800-9931
Hours of Operation:
8am-7pm CST

PRODUCTS & PARTS

Phone: 800-755-5100
Hours of Operation:
11am-7pm EST

This catalog contains the registered and unregistered trademarks of Wilson Sporting Goods Co. as reflected by the names used herein.

Little League Baseball is a registered trademark of Little League Baseball, Incorporated. ASA is a registered trademark of Amateur Softball Association of America. ISA is a registered trademark of the Independent Softball Association. MLB Authentic Collection, MLB and MLB team names are registered trademarks of Major League Baseball Properties, Inc. MiLB is a registered trademark of National Association of Professional Baseball Leagues, Inc. USSSA is a registered trademark of the United States Specialty Sports Association, Inc. ISF is a registered trademark of the International Softball Federation, Inc. NFHS is a registered trademark of National Federation of State High Schools. National Softball Association is a registered trademark of National Softball Association, Inc. BBCOR is a certified mark of The National Collegiate Athletic Association. NOCSAE is a registered trademark of the National Operating Committee on Standards for Athletic Equipment. Pony is a registered trademark of Pony Baseball, Inc. Dixie Youth Baseball is a registered trademark of Dixie Youth Baseball Inc. USA Baseball is a registered trademark of United States Baseball Federation. USA Softball is a registered trademark of USA Softball, Inc. Babe Ruth League is a registered trademark of Babe Ruth League, Inc. Cal Ripken Baseball is a trademark of Babe Ruth League, Inc. FlexFit is a registered trademark of Yupoung Inc. Exo Armor is a registered trademark of INC International Co. Velcro is a registered trademark of Velcro Industries B.V. Dri-Lex is a registered trademark of Faytex Corp. Fidlock is a registered trademark of Fidlock GmbH. Autism Speaks is a registered trademark of Autism Speaks, Inc. SAS-TEC is a trademark of SaS-Tec GmbH. Crash Cloud is a registered trademark of Windpact, Inc. NSA is a trademark of National Softball Association. WBSC is a trademark of the World Baseball Softball Confederation.

Trademarks advertised other than those of Wilson Sporting Goods Co. are properties of their respective companies.

NOTE: The display of logos in this catalog does not constitute an endorsement or sponsorship of Wilson merchants by the respective organization.



facebook.com/WilsonBaseball
facebook.com/Demarini.Sports
facebook.com/LouisvilleSlugger
facebook.com/EvoShield



@WilsonBallGlove
@DeMarini
@SluggerNation
@EvoShield



@WilsonBallGlove
@DeMarini
@SluggerNation
@EvoShield



Wilson Baseball/Softball
DeMarini Sports
Louisville Slugger
EvoShield

USERNAME:

PASSWORD:

ACCOUNT NO:

B2B

URL: www.wilsonb2b.com

wilson.com
©2022 Wilson Sporting Goods Co.
All Rights Reserved Printed In USA
21-1442/4.22



2023 SPRING DEALER WORKBOOK

